

 **SCHONBEK** | 1870

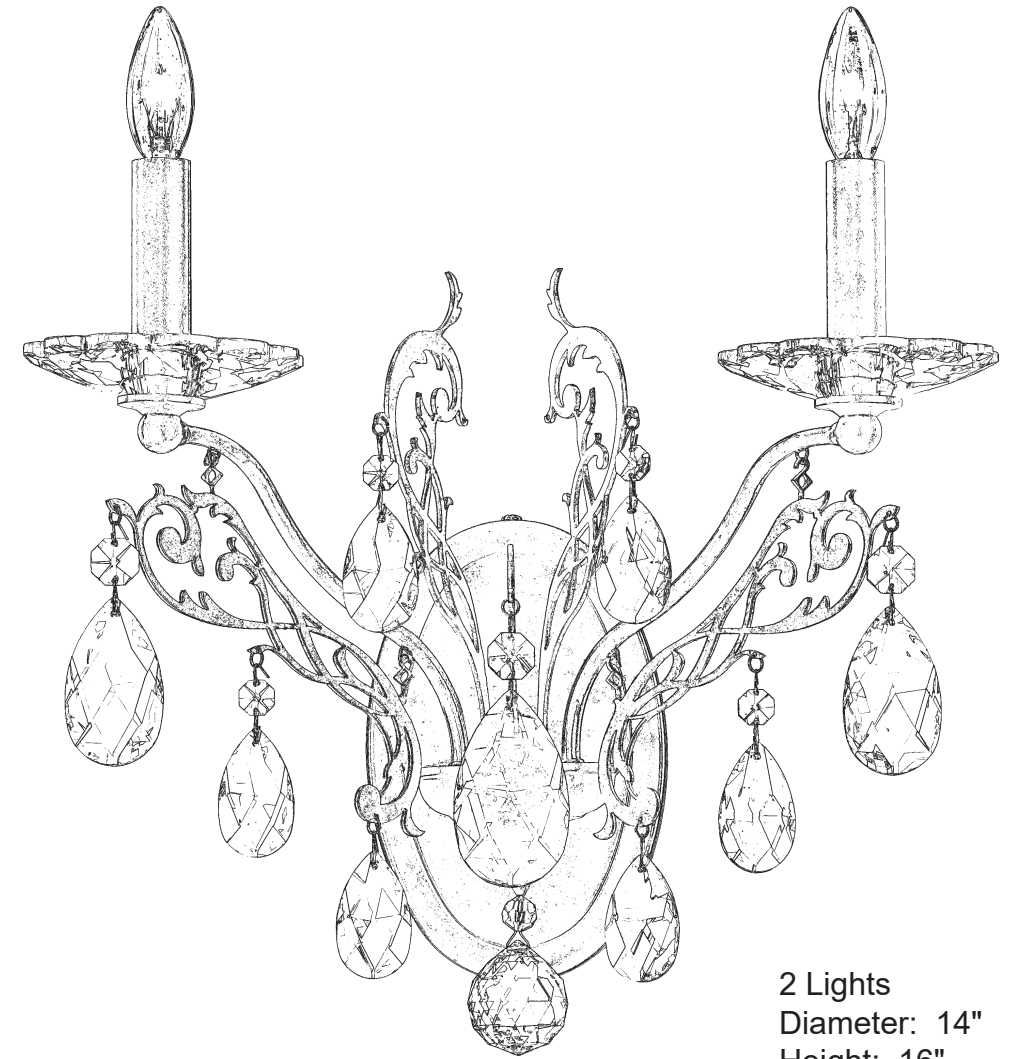







FILIGRAE FE7002N- ___ H



2 Lights
Diameter: 14"
Height: 16"
Extension: 9-1/2"
Hanging Weight: 6lbs.

THIS DESIGN IS THE PROPRIETARY
TRADE DRESS/TRADEMARK OF
W SCHONBEK LLC.

 **SCHONBEK** | 1870

			S					
MAX 60 W	110-120 V							

WARNING:

1

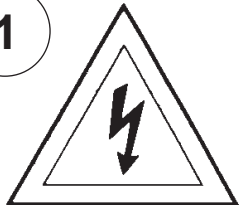

Electrical Danger

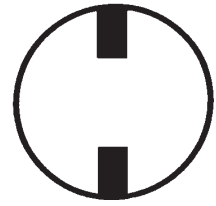

Turn Power Off

All electrical components must be installed by a licensed electrician in accordance with the National Electric Code and the appropriate local electrical codes.

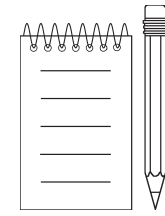
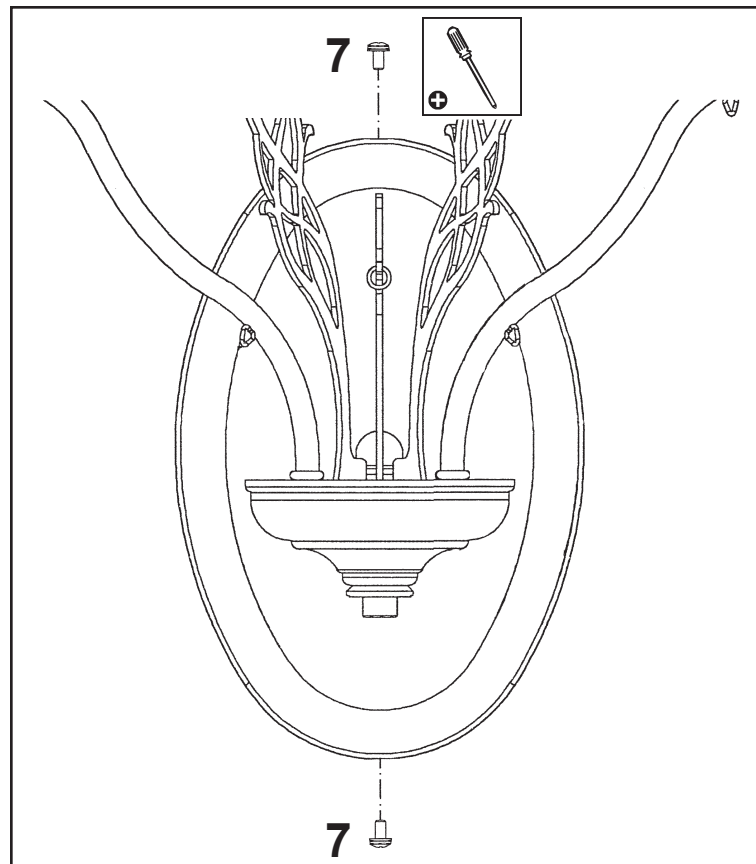
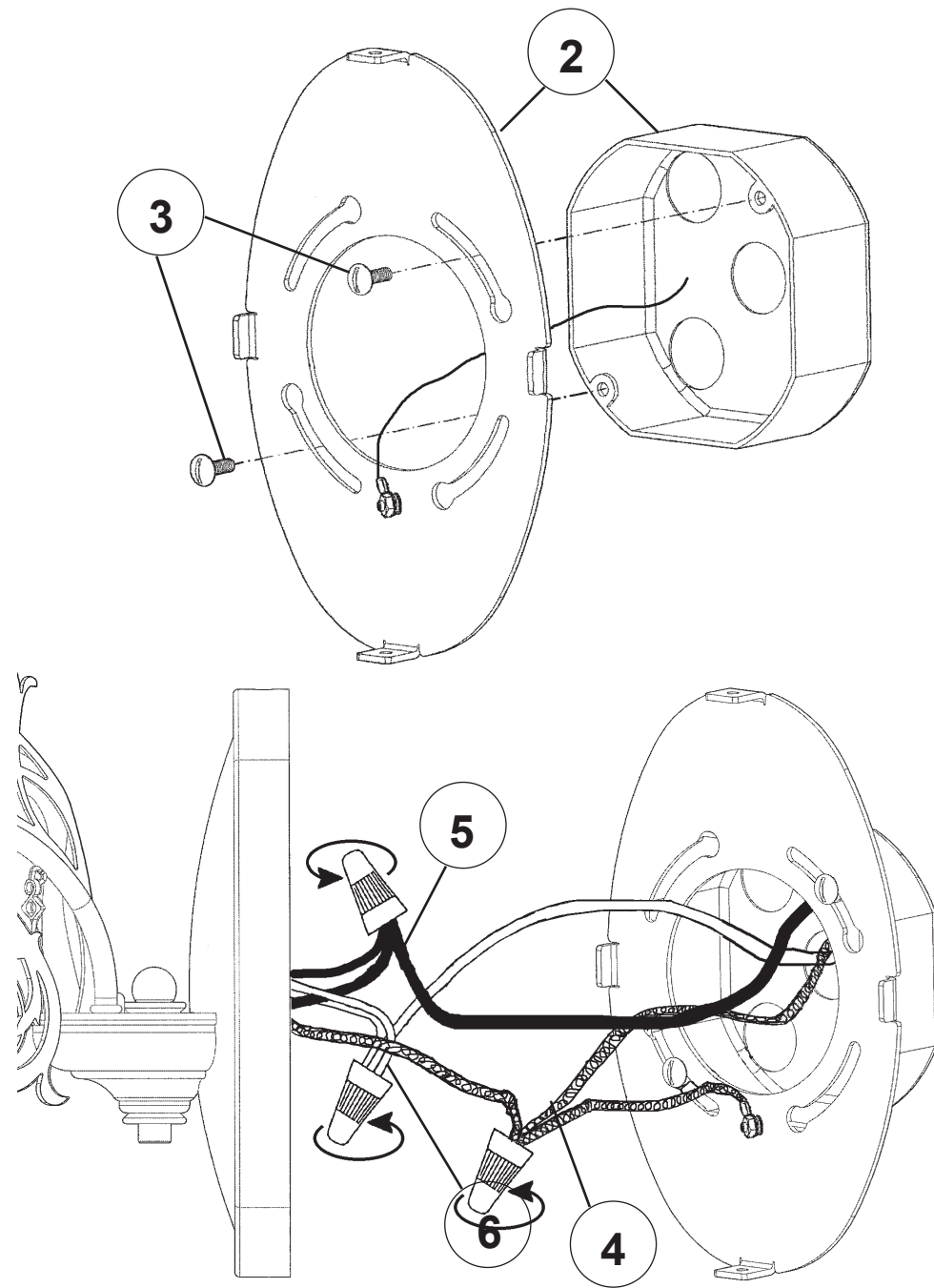

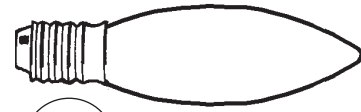
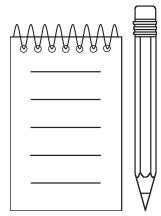

9

You will need 2 - B10
25 Watts Recommended
60 Watts Max

**Install bulbs and be sure
to test fixture BEFORE
trimming.**

