

FILIGRAE FE7066N- __ __ H













6 Lights
Diameter: 24"
Height: 22"
Hanging Weight: 18lbs.

THIS DESIGN IS THE PROPRIETARY
TRADE DRESS/TRADEMARK OF
W SCHONBEK LLC.

 **SCHONBEK** | 1870

 **SCHONBEK** | 1870

								
MAX <u>60</u> W	110-120 V							

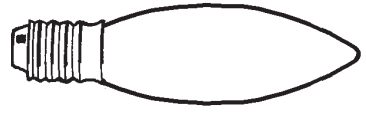

You will need 6 - B10
25 Watts Recommended
60 Watts Max

**Install bulbs and be sure
to test fixture BEFORE
trimming.**

7 X : 1059-**

7 X : 42/016/5-**

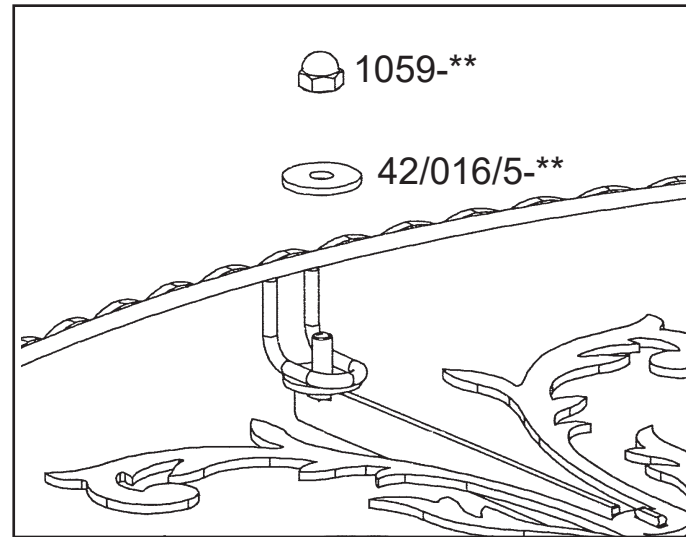

**NOTE: INSTALL BOBECHE,
CANDLESLIPS AND BULBS
BEFORE INSTALLING SHADE.**

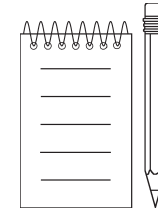
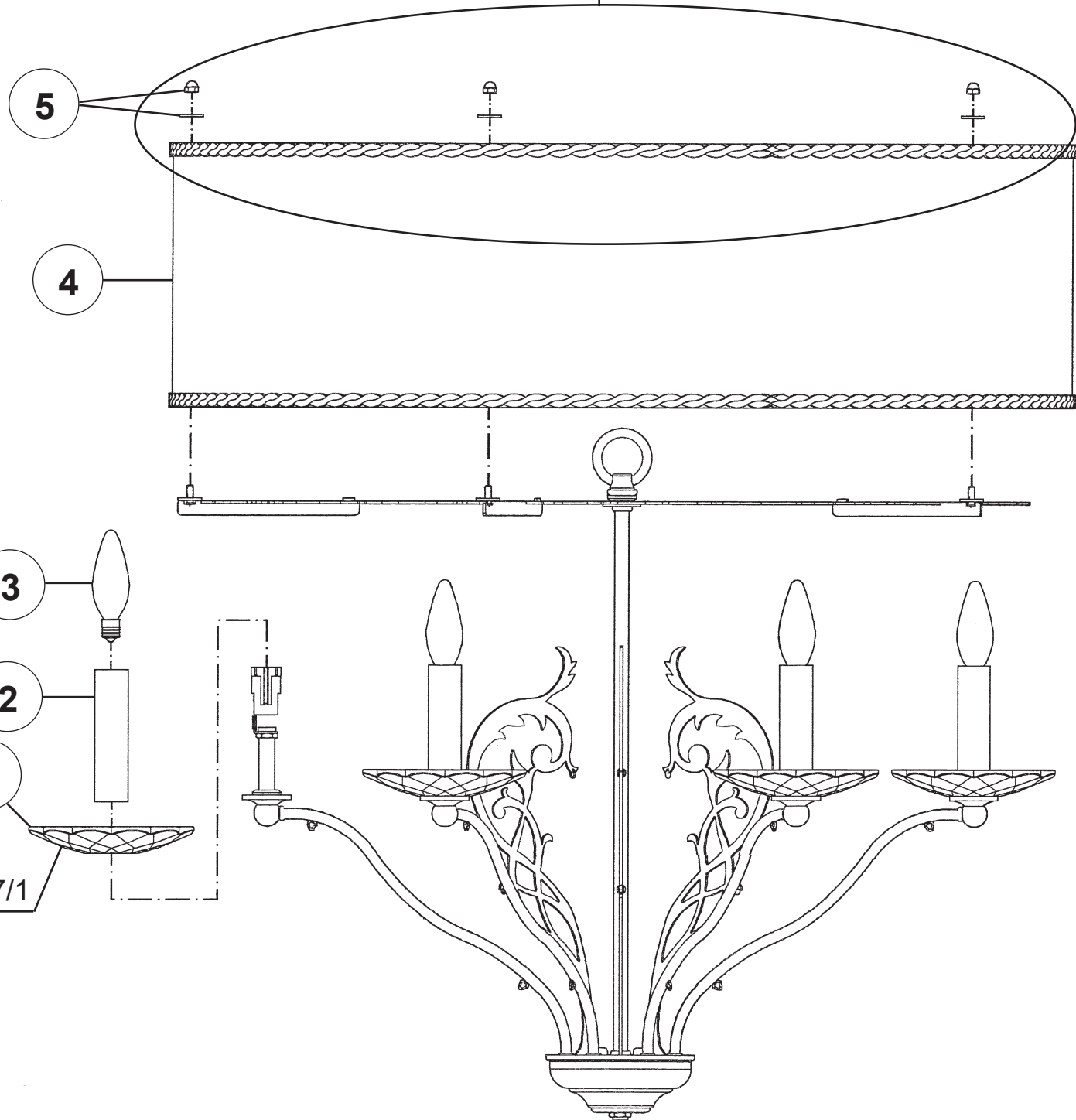

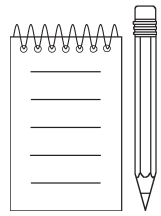

WARNING:

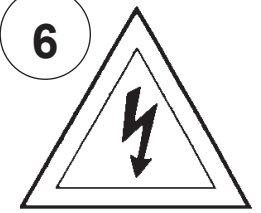
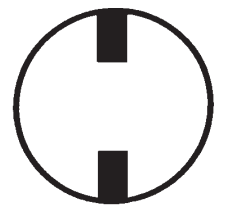
6  

Electrical Danger **Turn Power Off**

All electrical components must be installed by a licensed electrician in accordance with the National Electric Code and the appropriate local electrical codes.

