

 **SCHONBEK** | 1870

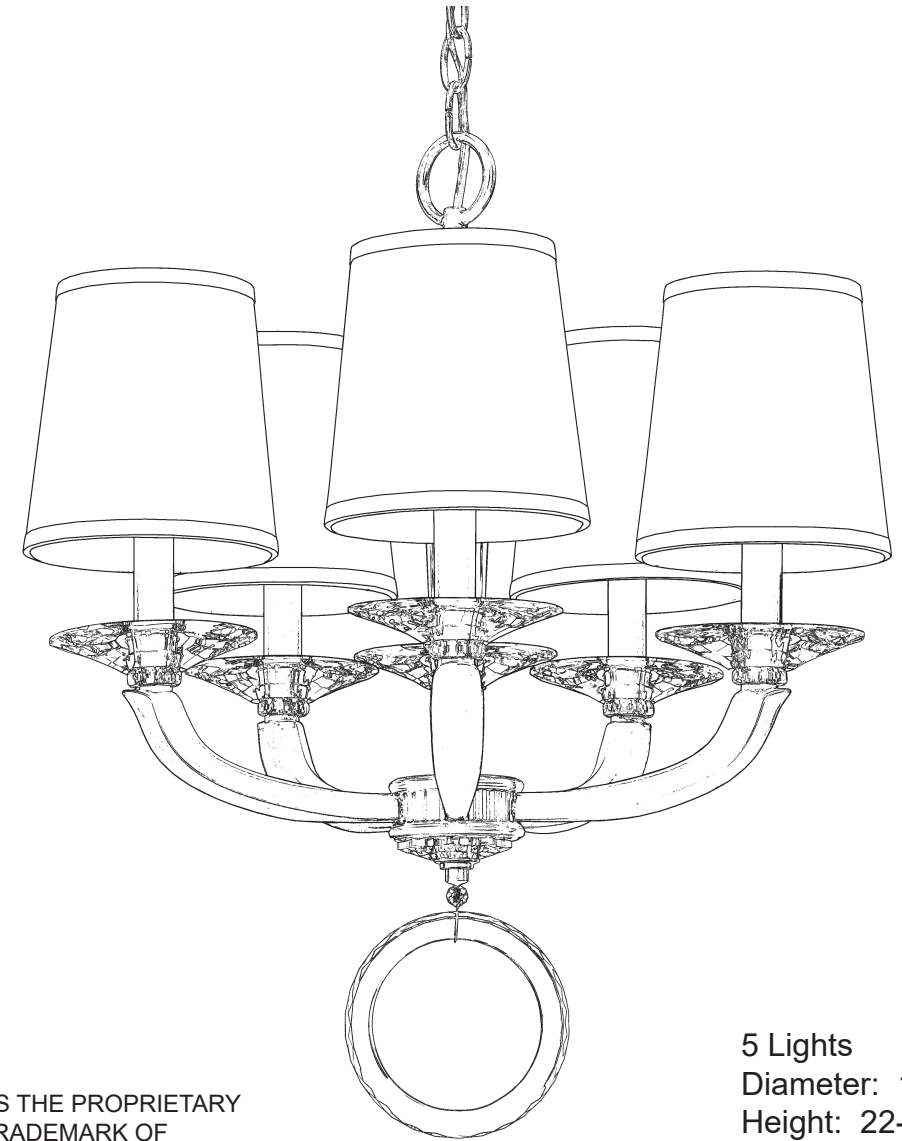









EMILEA MA1005N- __ __ O



THIS DESIGN IS THE PROPRIETARY
TRADE DRESS/TRADEMARK OF
W SCHONBEK LLC.

5 Lights
Diameter: 19-1/2"
Height: 22-1/2"
Hanging Weight: 14lbs.

 **SCHONBEK** | 1870

			S						
MAX 40 W	110-120 V								

WARNING:

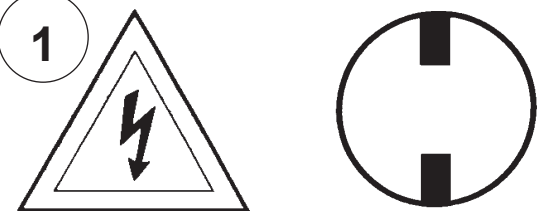
1 

Electrical Danger Turn Power Off

All electrical components must be installed by a licensed electrician in accordance with the National Electric Code and the appropriate local electrical codes.

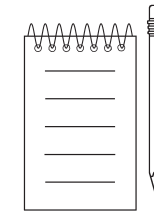
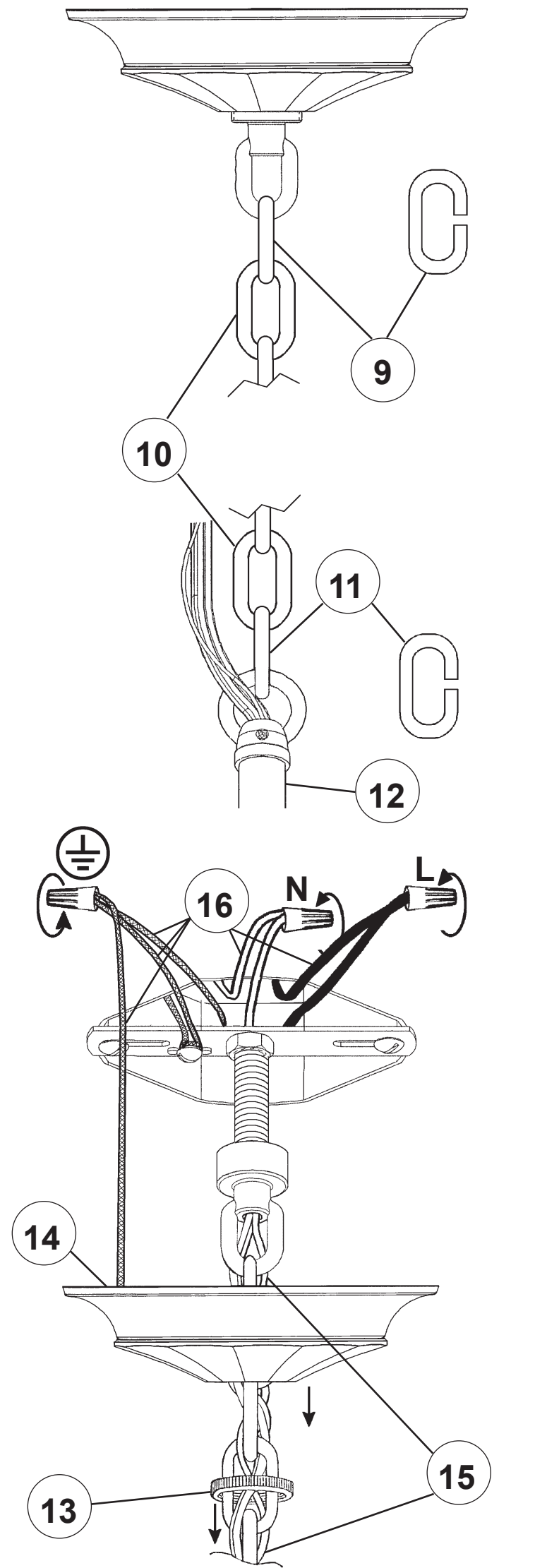
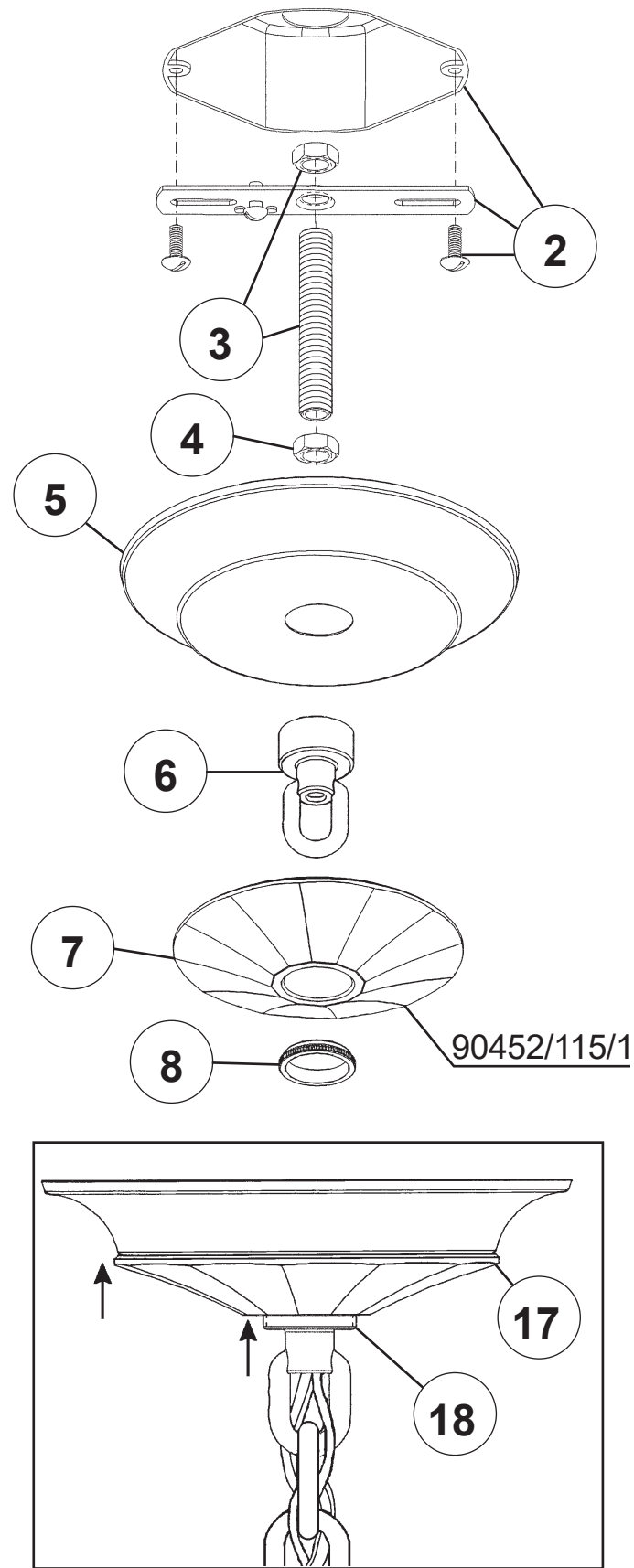

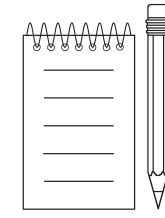
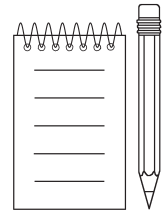

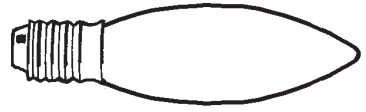

You will need 5 - B10
25 Watts Recommended
40 Watts Max

**Install bulbs and be sure
to test fixture BEFORE
trimming.**

