

EMILEA MA1008N- __ __ O

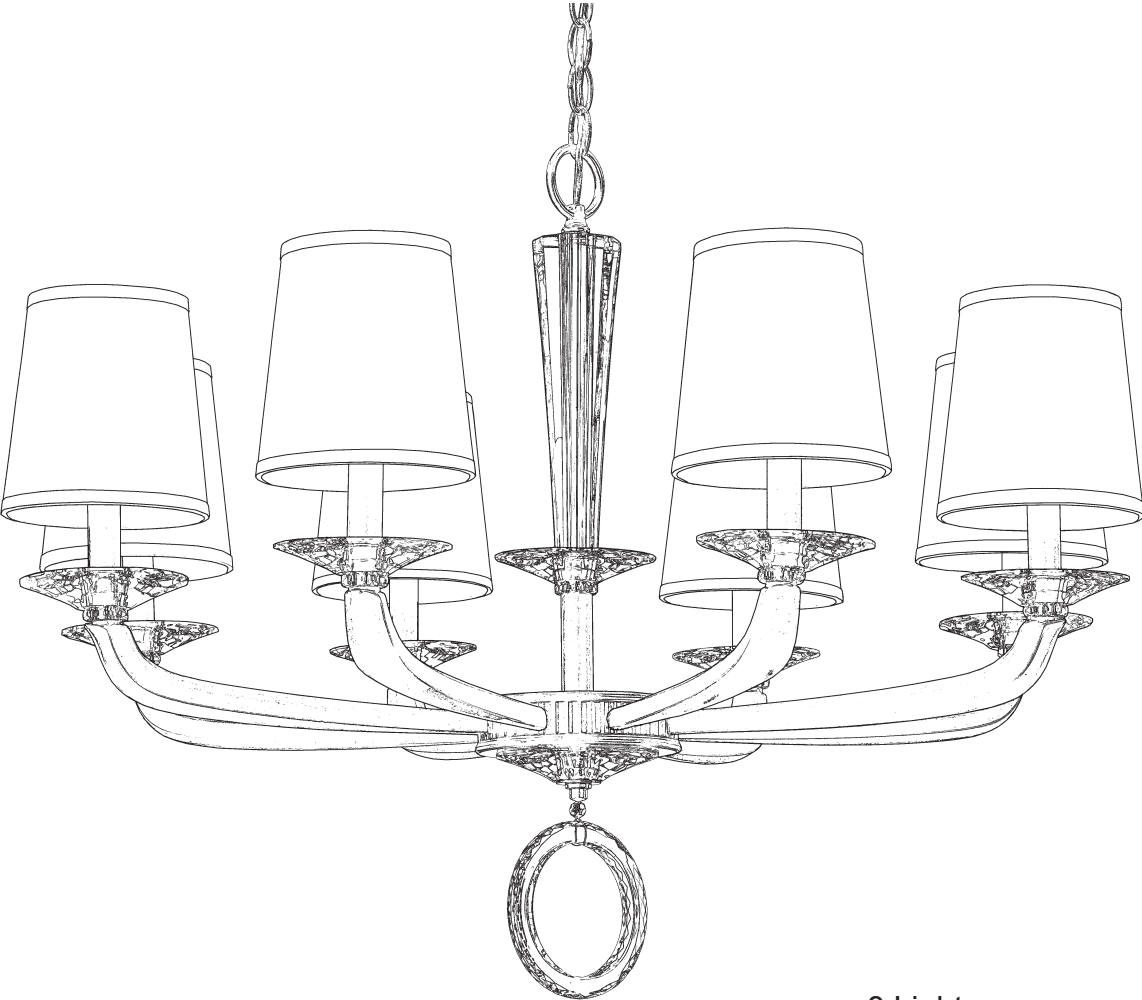











8 Lights
Diameter: 33"
Height: 24"
Hanging Weight: 26lbs.

THIS DESIGN IS THE PROPRIETARY
TRADE DRESS/TRADEMARK OF
W SCHONBEK LLC.

 **SCHONBEK** | 1870

 **SCHONBEK** | 1870

								
MAX 40 W		110-120 V						

WARNING:

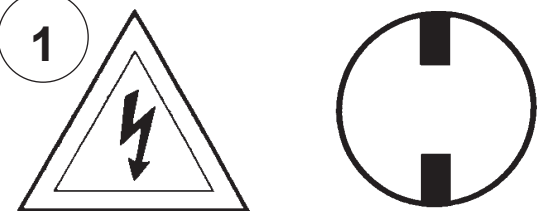
1 

Electrical Danger Turn Power Off

All electrical components must be installed by a licensed electrician in accordance with the National Electric Code and the appropriate local electrical codes.

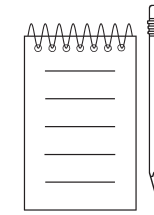
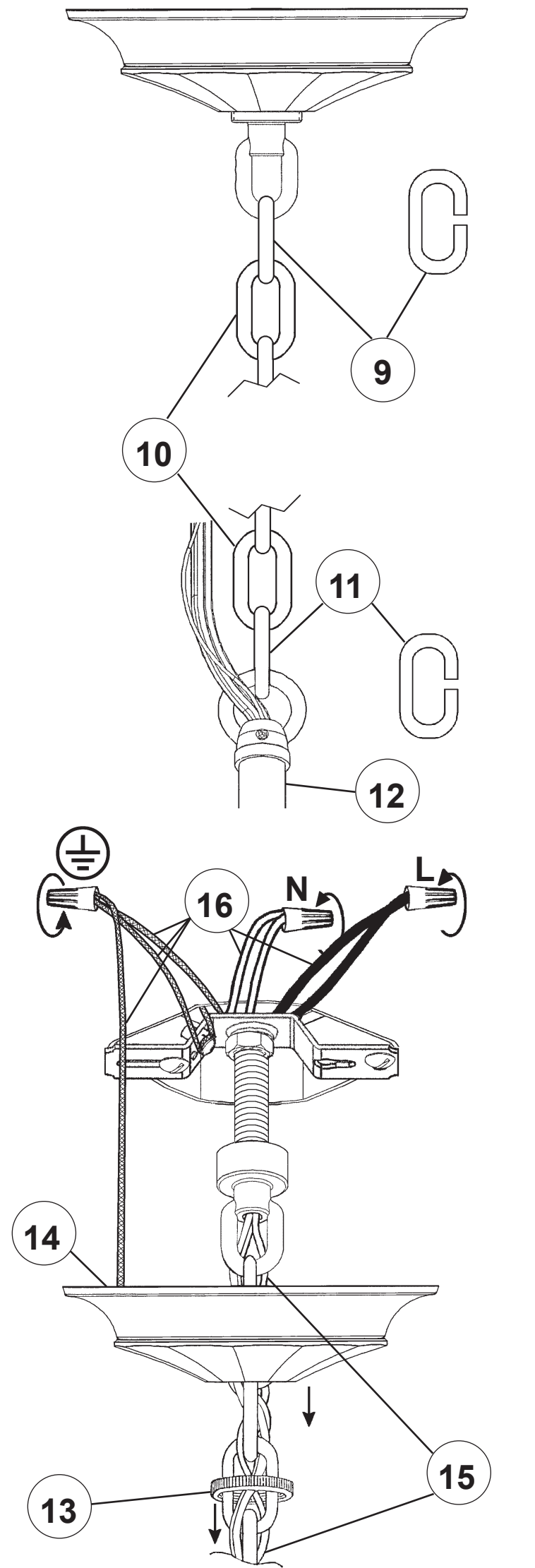
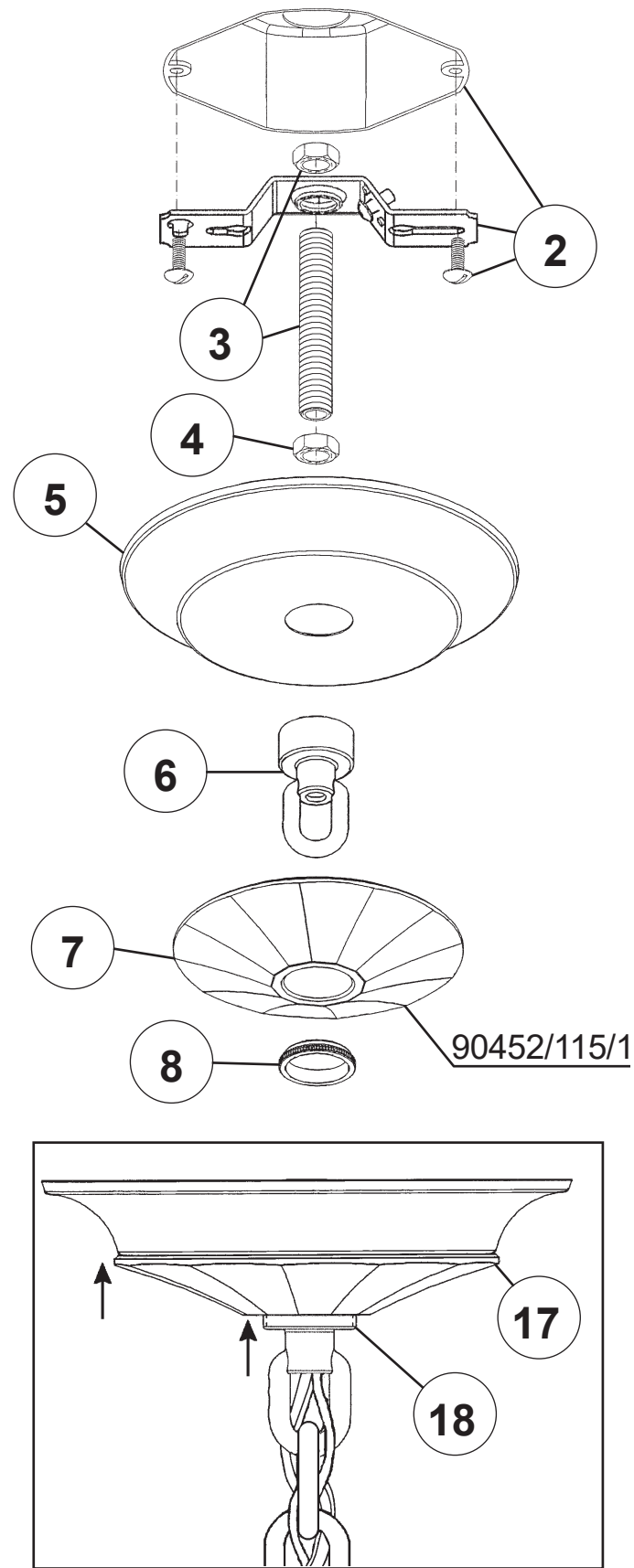

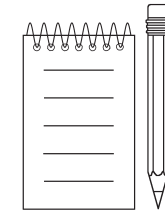
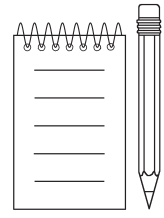

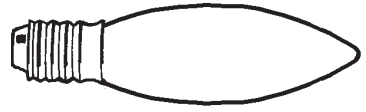

You will need 8 - B10
25 Watts Recommended
40 Watts Max

Install bulbs and be sure
to test fixture **BEFORE**
trimming.

