

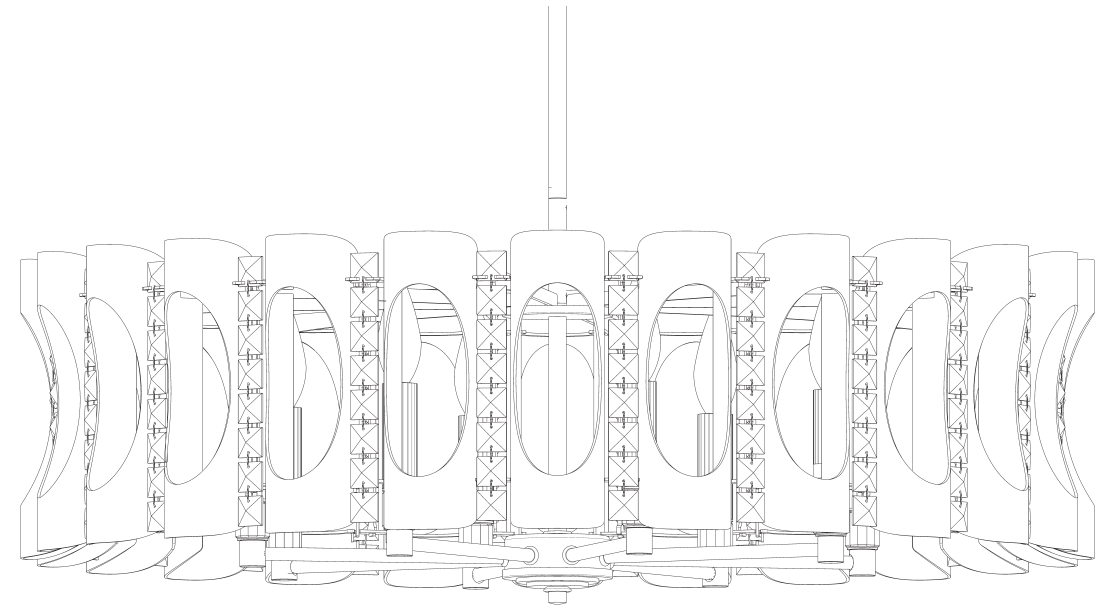

TWILIGHT MR1008N-__ __O



THIS DESIGN IS THE PROPRIETARY
TRADE DRESS/TRADEMARK OF
W SCHONBEK LLC.

8 Lights
Diameter: 31"
Height: 8-1/2"
Hanging Weight: 29lbs.



MAX 60 W	110-120 V						

1

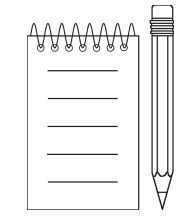
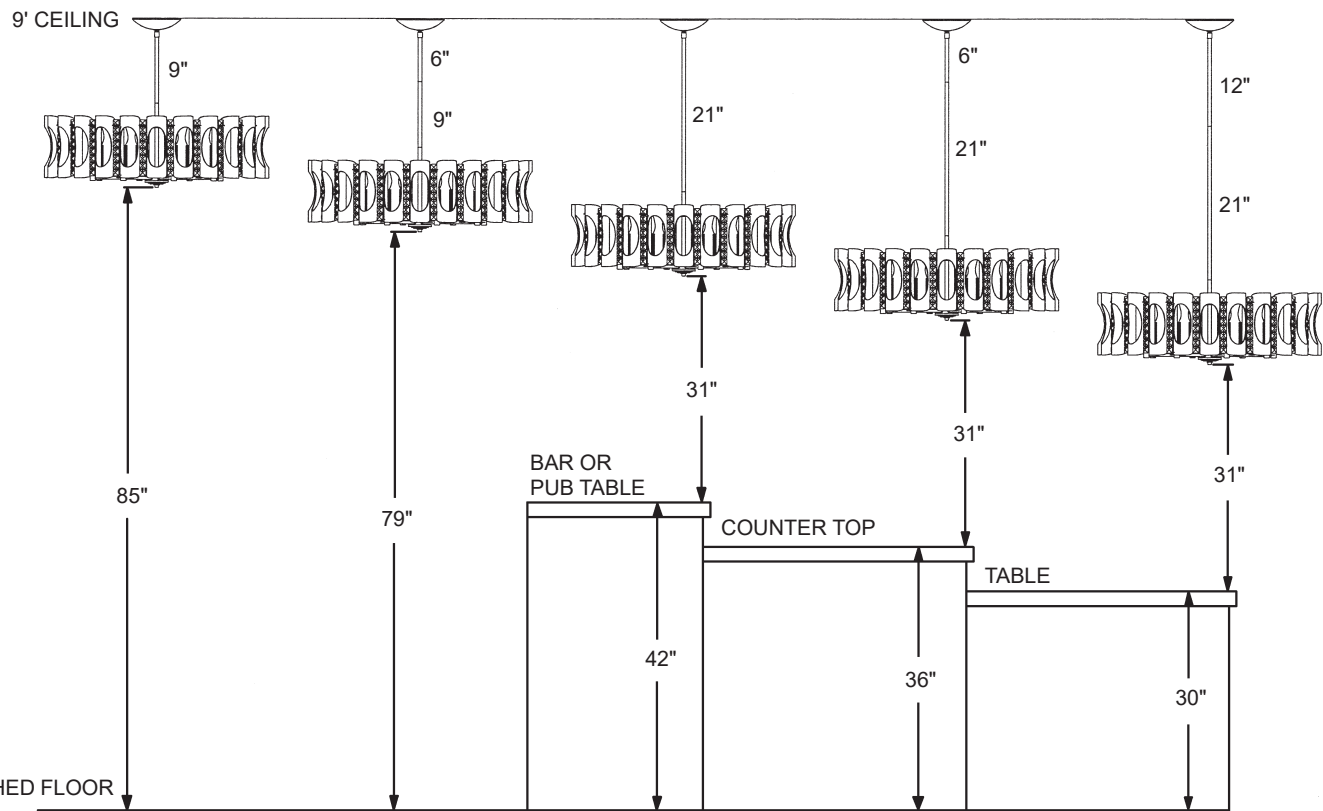
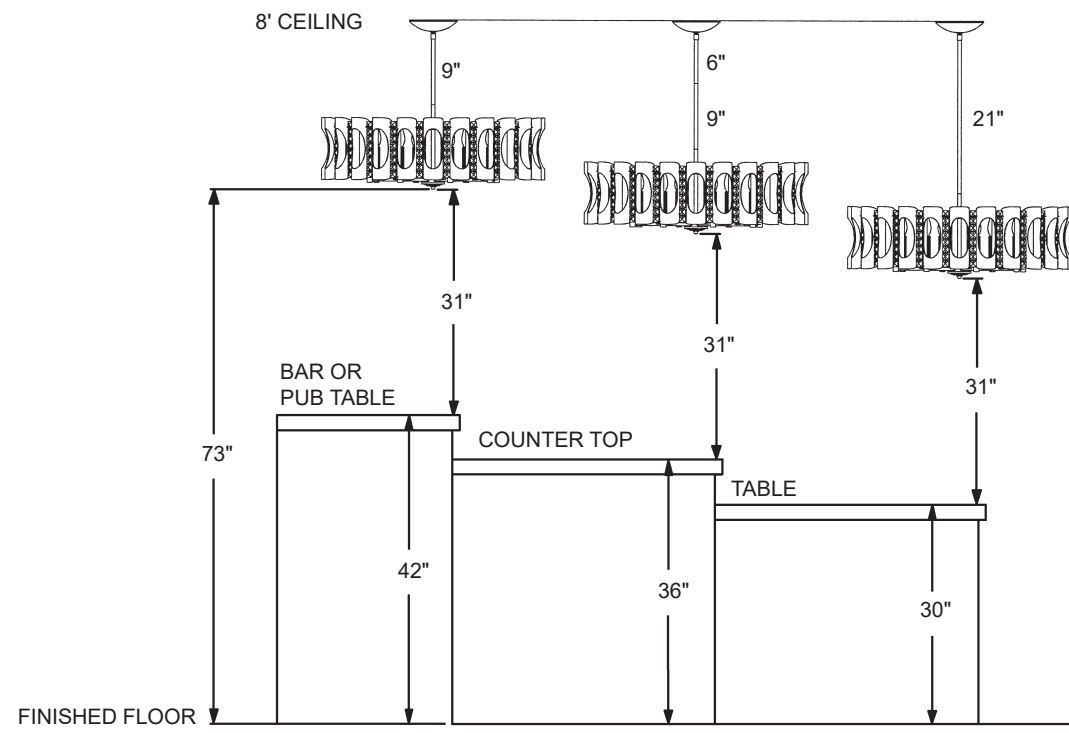

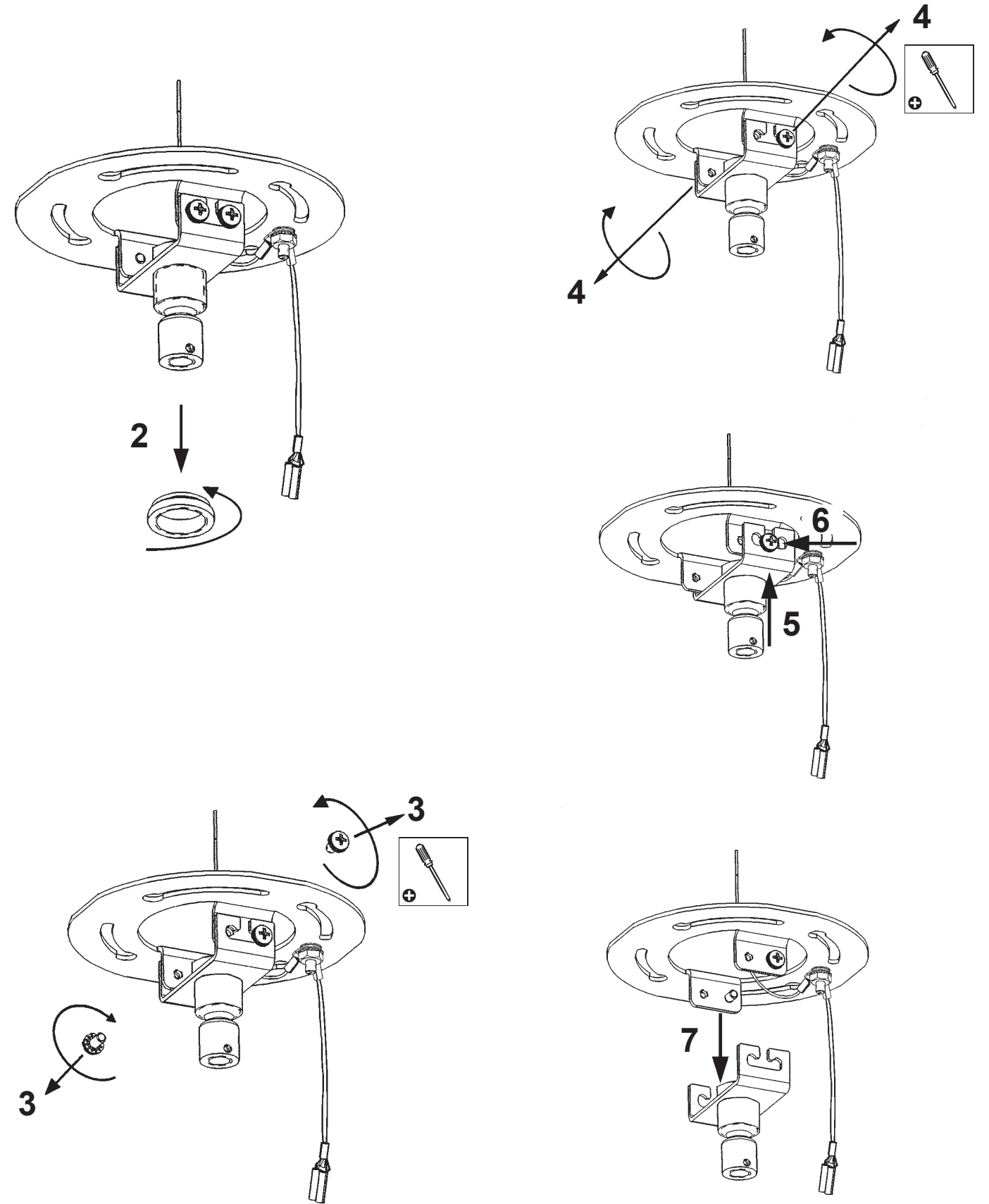
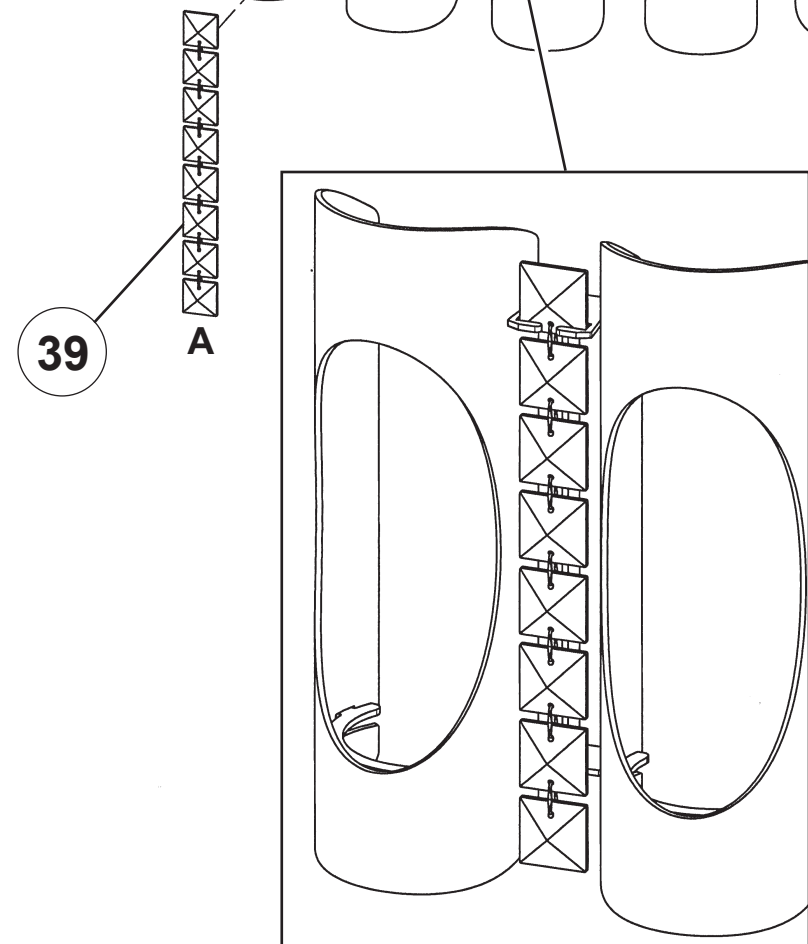
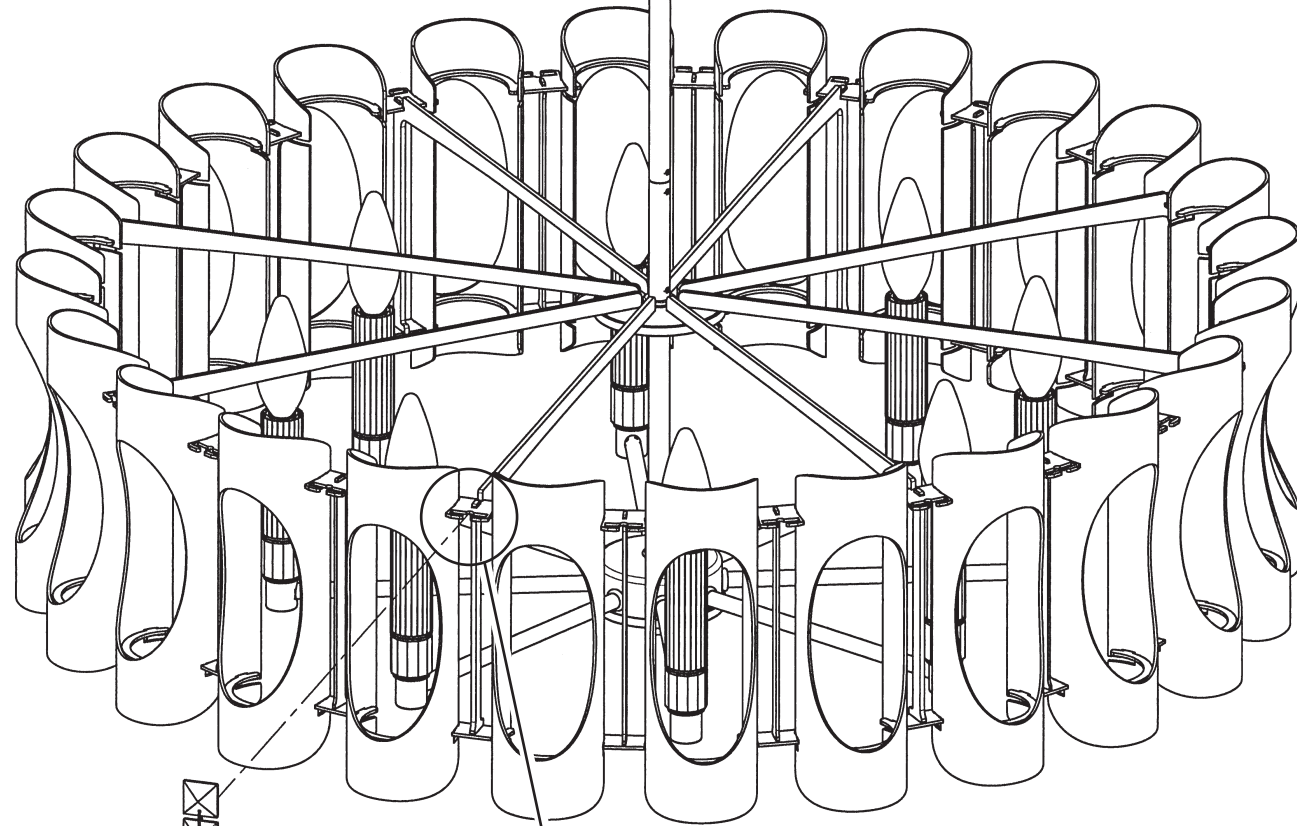

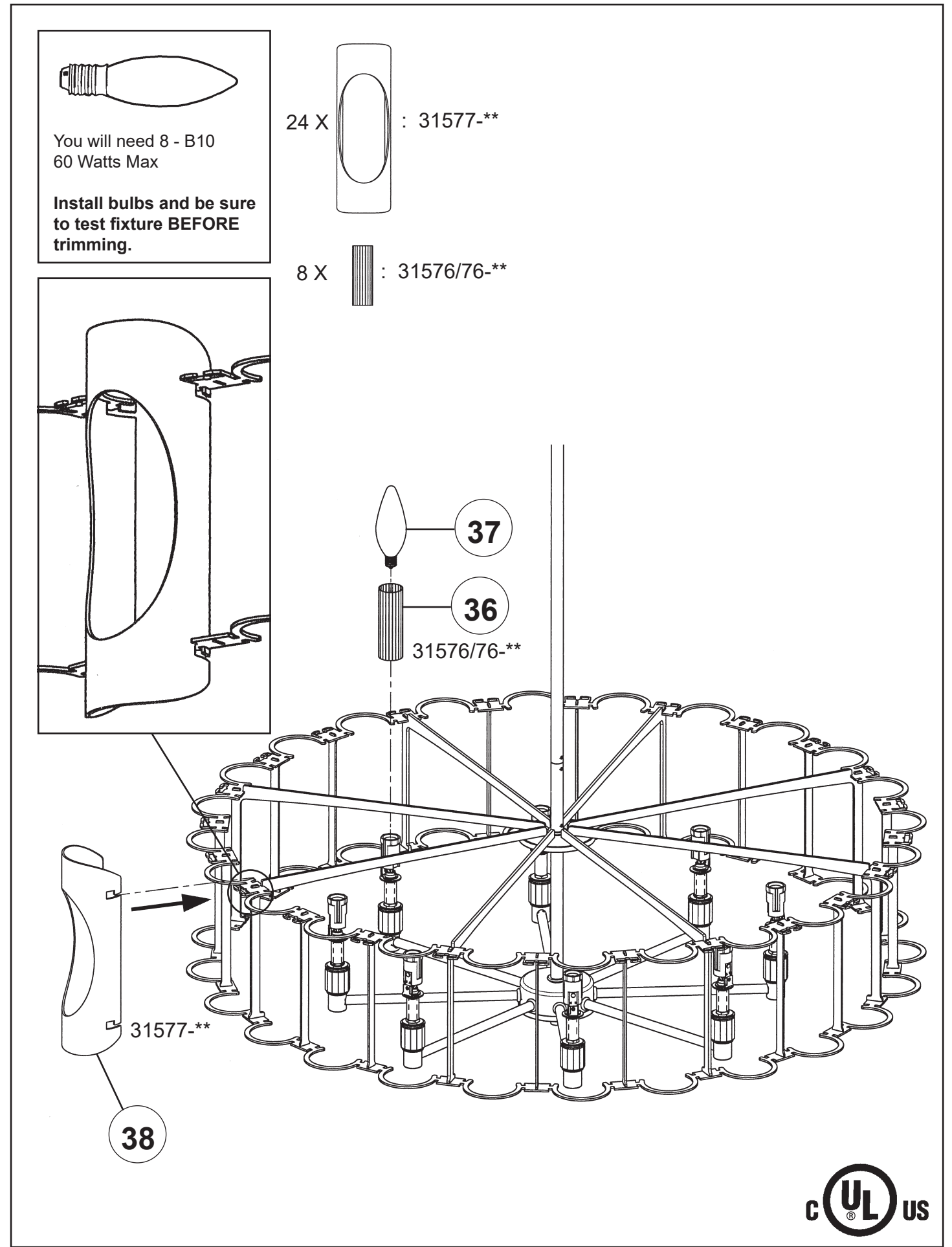
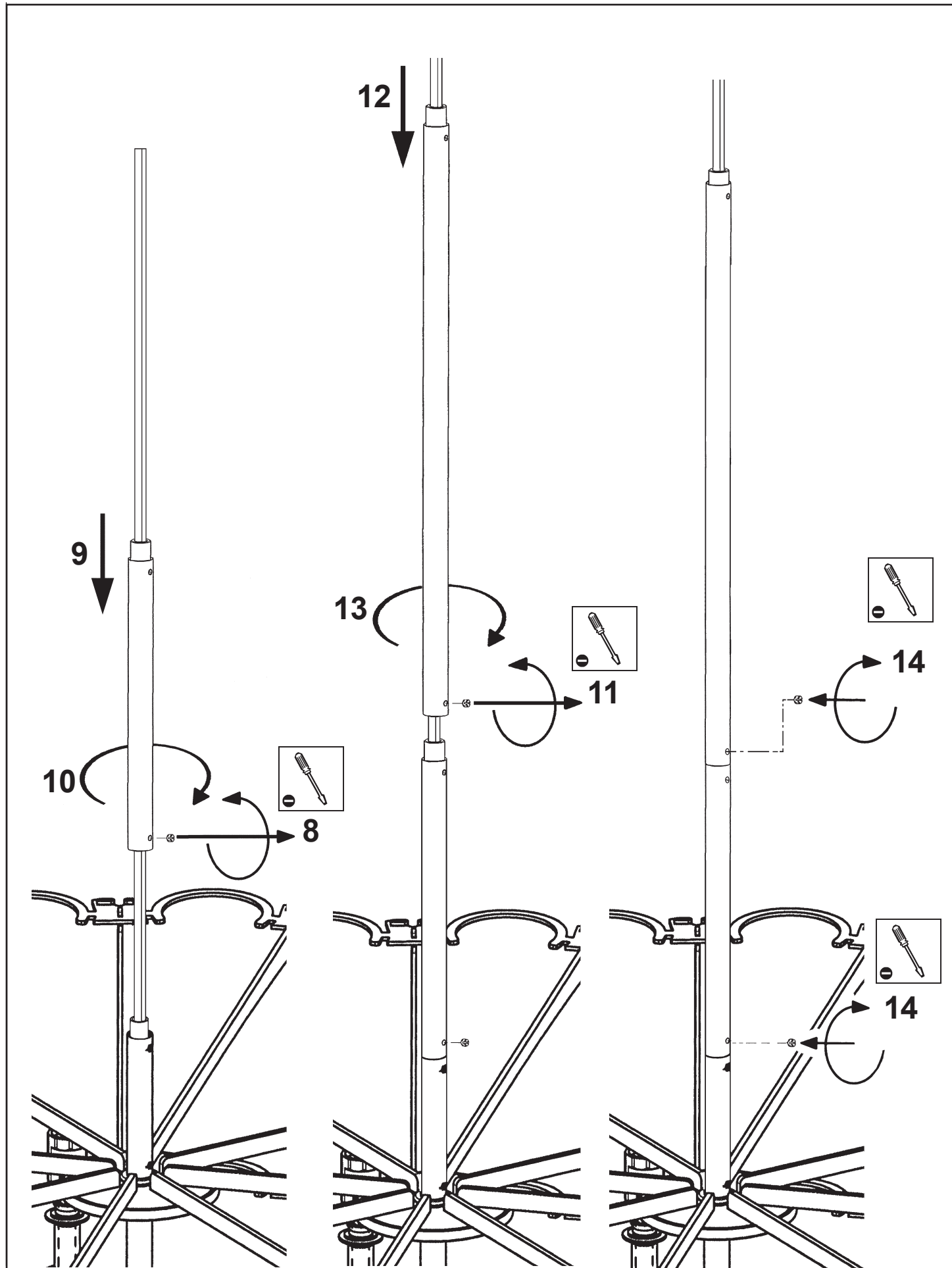

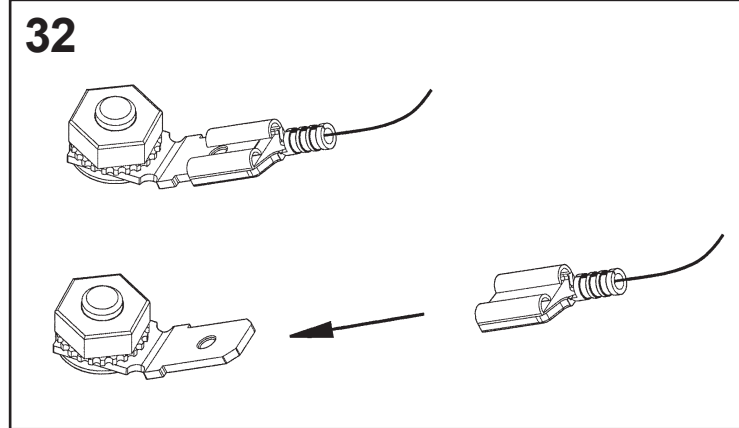
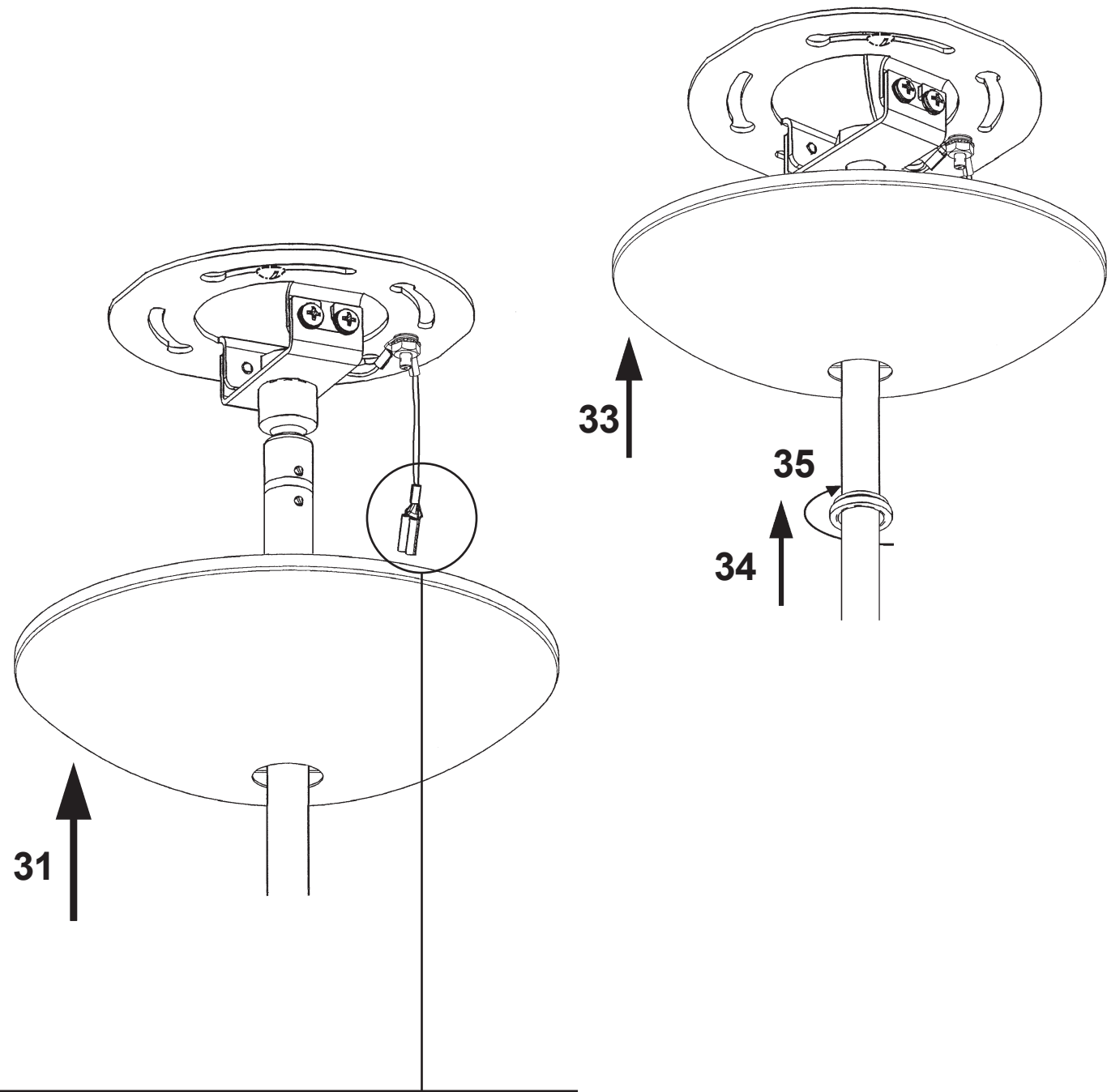

1 X  : 11384-**

