

VERDANA RJ1018N-__ __O

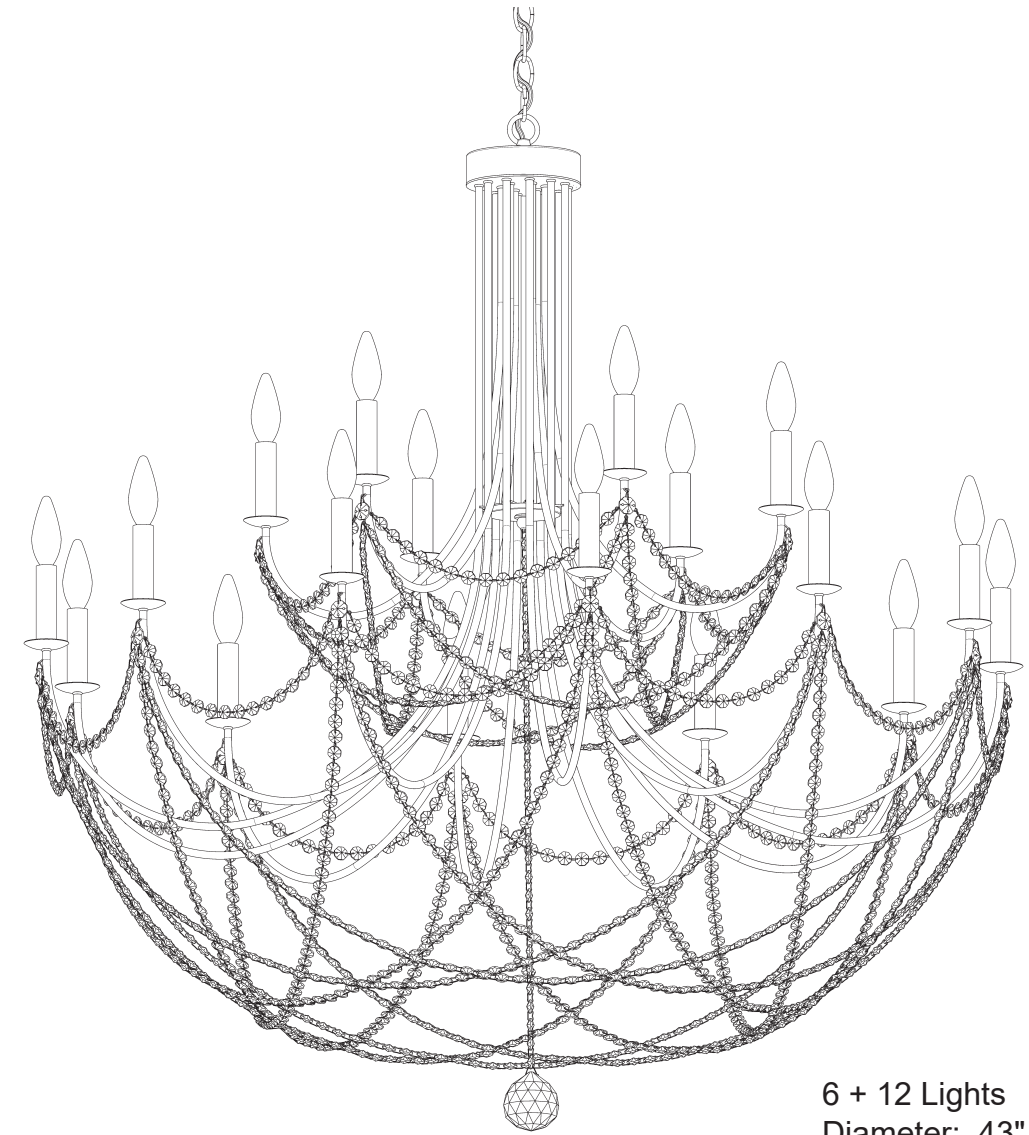











6 + 12 Lights
Diameter: 43"
Height: 42-1/2"
Hanging Weight: 22lbs.

THIS DESIGN IS THE PROPRIETARY
TRADE DRESS/TRADEMARK OF
W SCHONBEK LLC.

 **SCHONBEK** | 1870

 **SCHONBEK** | 1870

								
MAX <u>60</u> W	110-120 V							

WARNING:

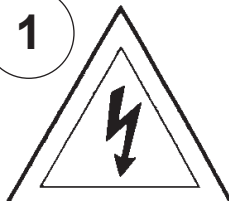
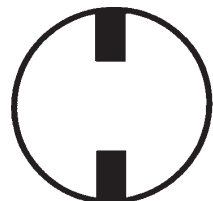
1  

Electrical Danger Turn Power Off

All electrical components must be installed by a licensed electrician in accordance with the National Electric Code and the appropriate local electrical codes.

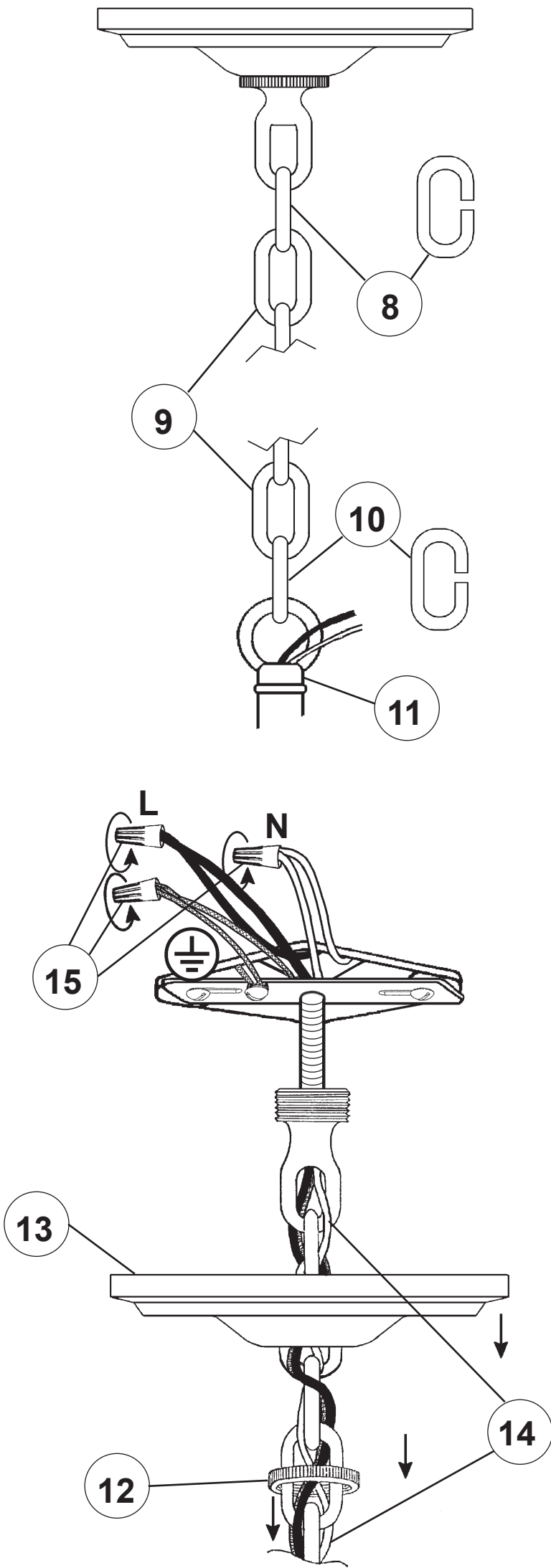
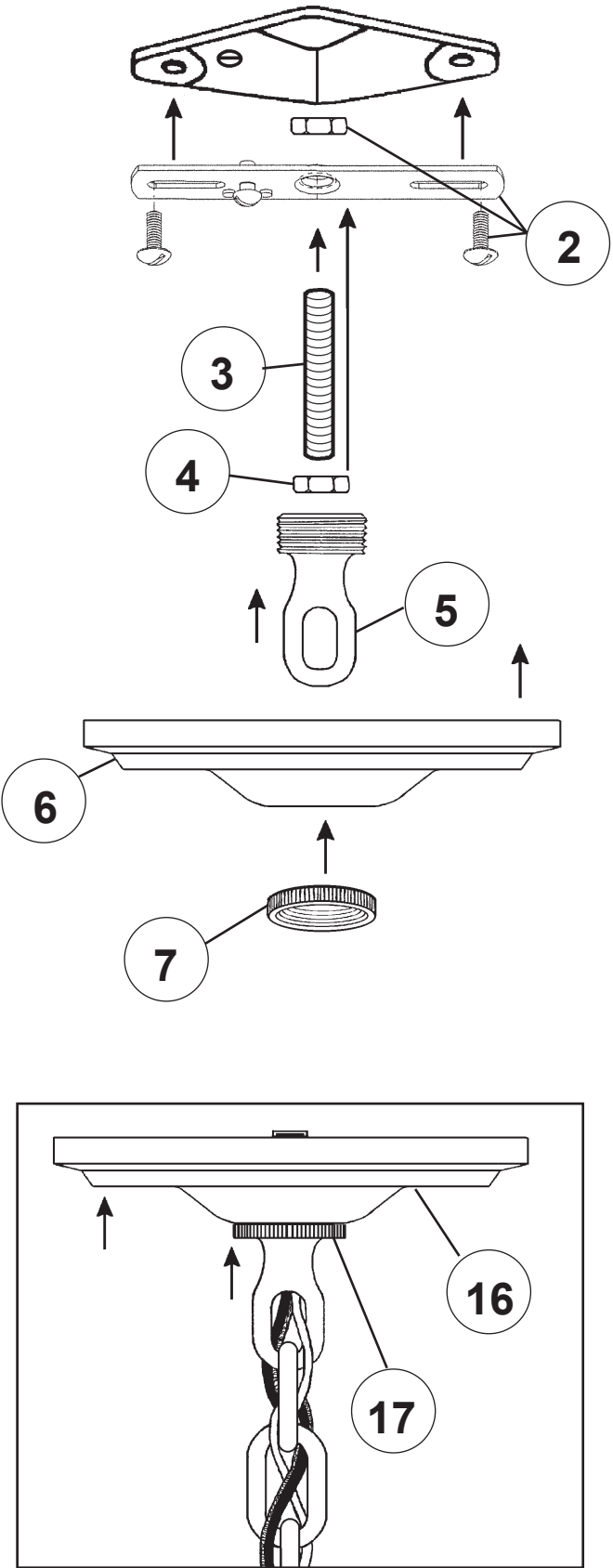

DIAGRAM 3
(BOTTOM VIEW - LOWER TIER ARMS)

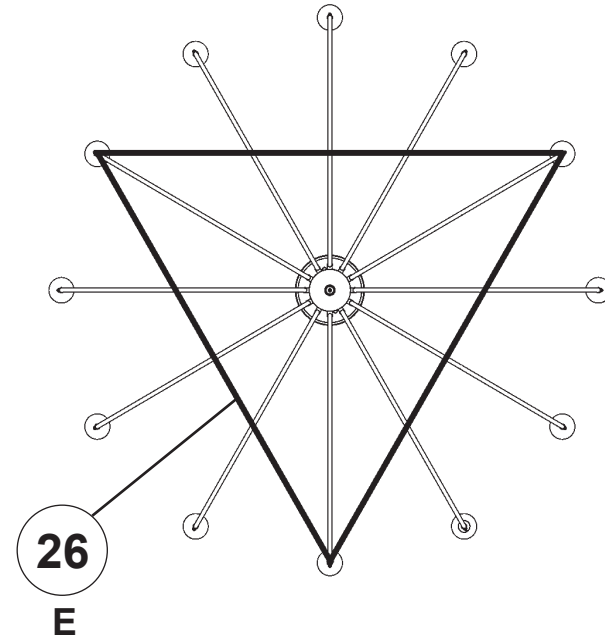

DIAGRAM 4
(BOTTOM VIEW - LOWER TIER ARMS)

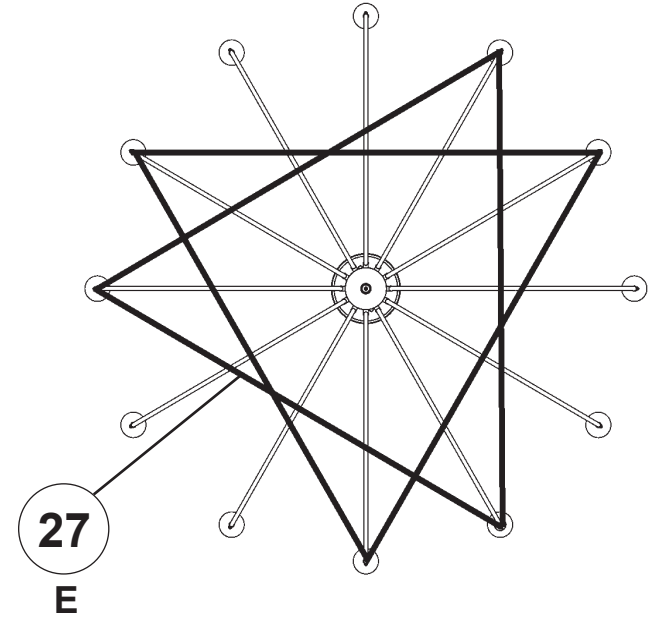

DIAGRAM 5
(BOTTOM VIEW - LOWER TIER ARMS)

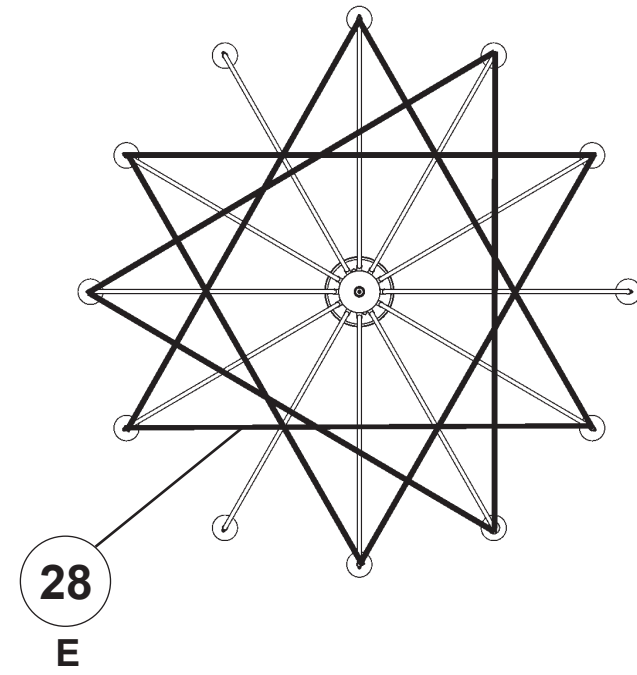
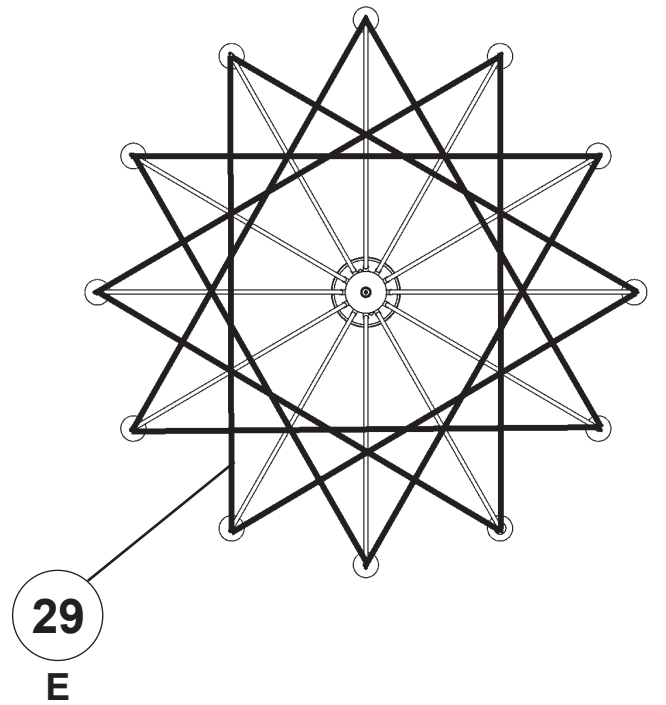
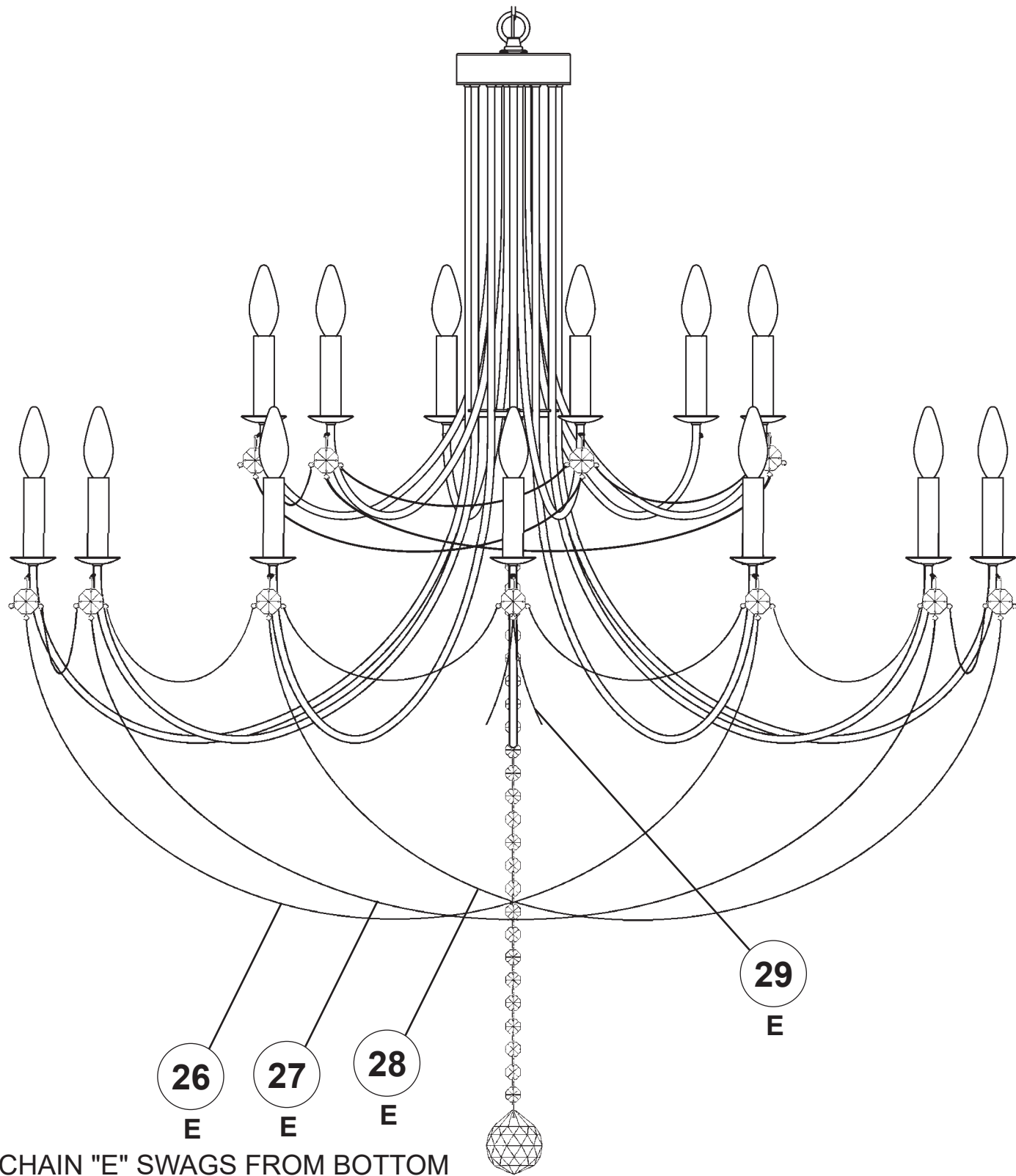

DIAGRAM 6
(BOTTOM VIEW - LOWER TIER ARMS)





CHAIN "E" SWAGS FROM BOTTOM
PIGTAIL ON OCTAGON OF ONE ARM TO
THE BOTTOM PIGTAIL ON OCTAGON
OF EVERY FOURTH ARM -
REFERENCE DIAGRAMS 3 - 6
ON PAGE 7

18

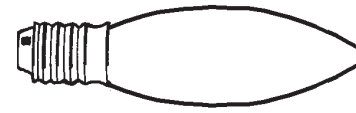

You will need 18 - B10
60 Watts Max

Install bulbs and be sure to
test fixture **BEFORE**
trimming.

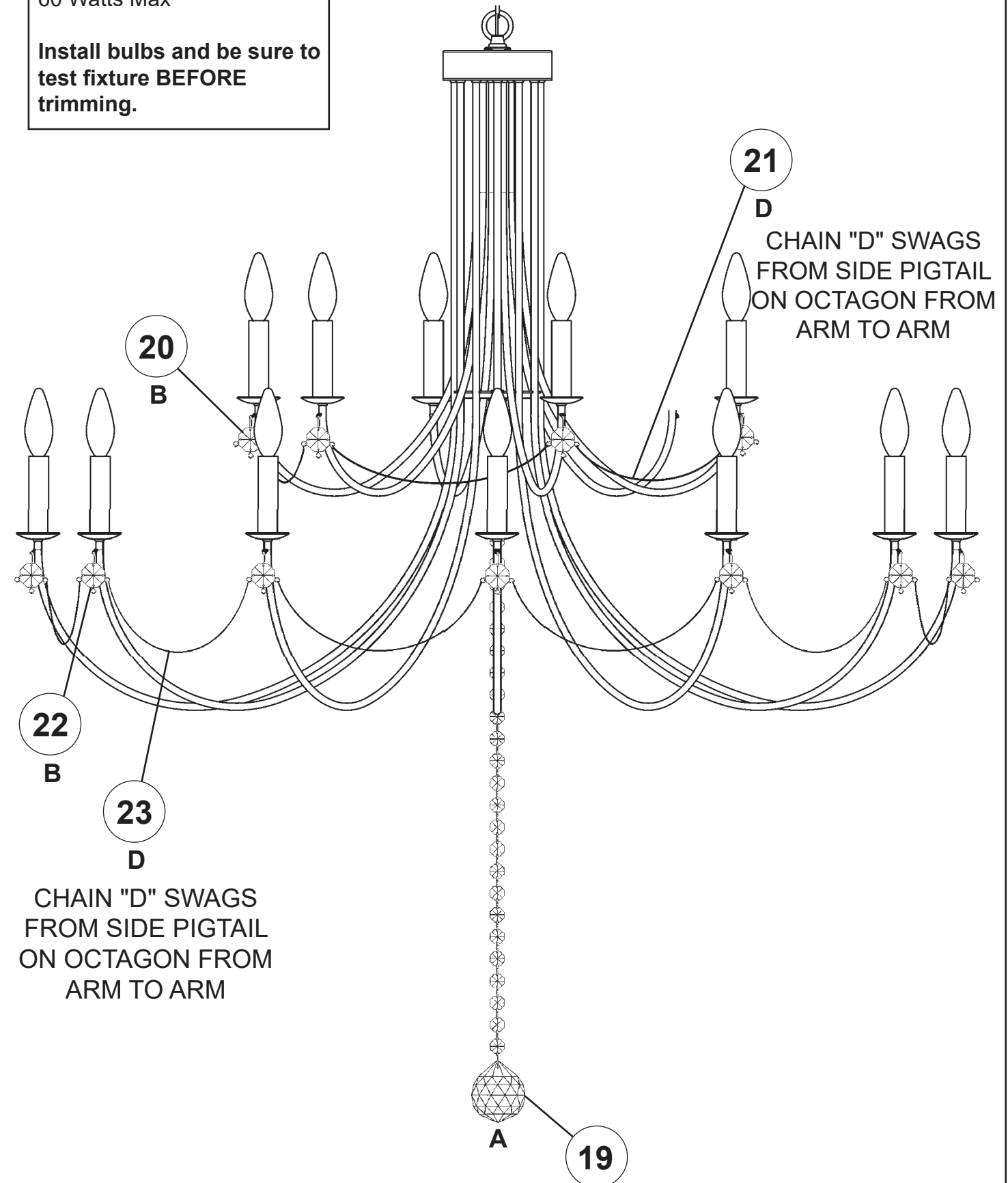

CHAIN "D" SWAGS
FROM SIDE PIGTAIL
ON OCTAGON FROM
ARM TO ARM

21

D
CHAIN "D" SWAGS
FROM SIDE PIGTAIL
ON OCTAGON FROM
ARM TO ARM

20

B

22

B

23

D

A

19

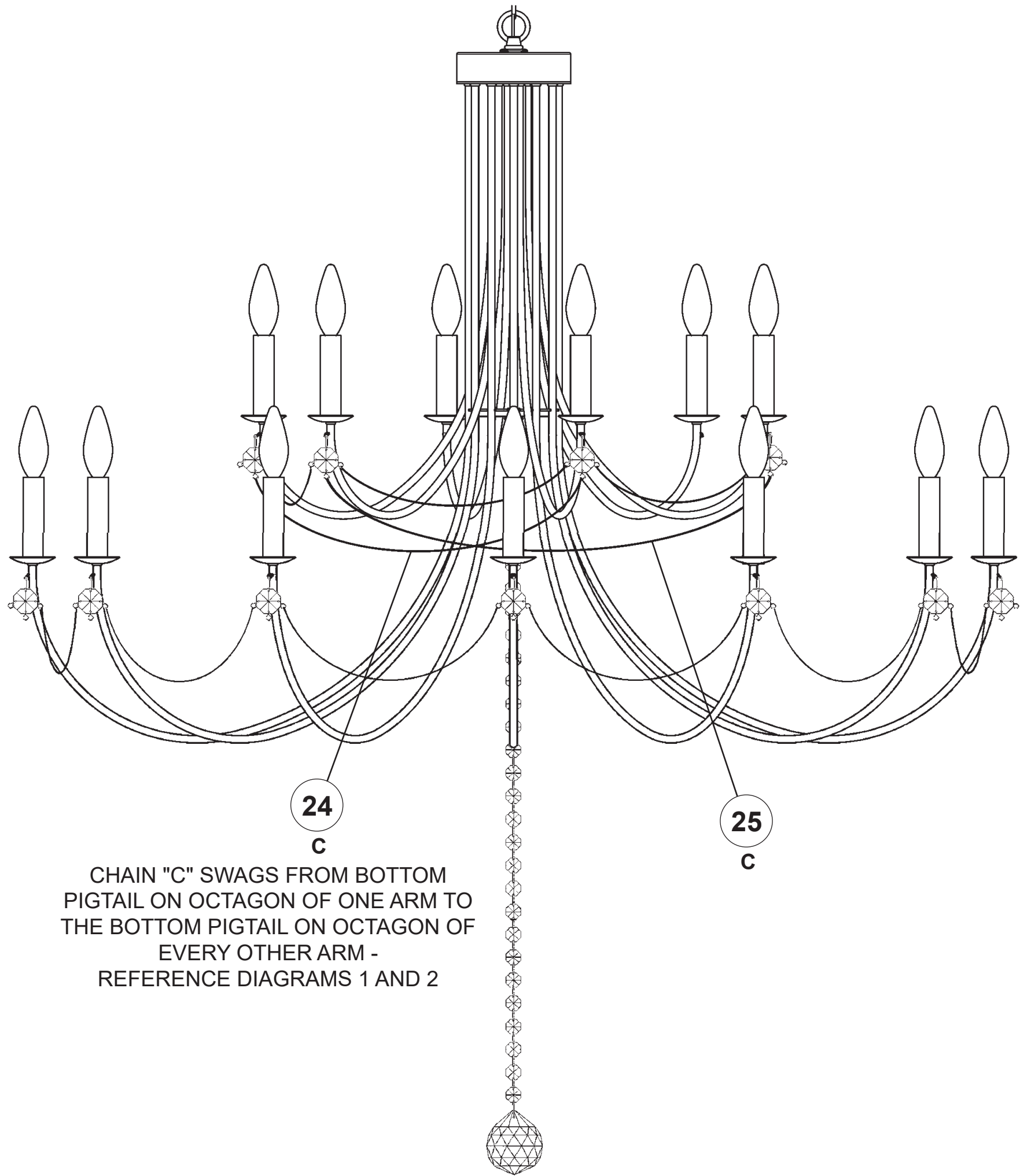

CHAIN "C" SWAGS FROM BOTTOM
PIGTAIL ON OCTAGON OF ONE ARM TO
THE BOTTOM PIGTAIL ON OCTAGON OF
EVERY OTHER ARM -
REFERENCE DIAGRAMS 1 AND 2

DIAGRAM 1
(BOTTOM VIEW - UPPER TIER ARMS)

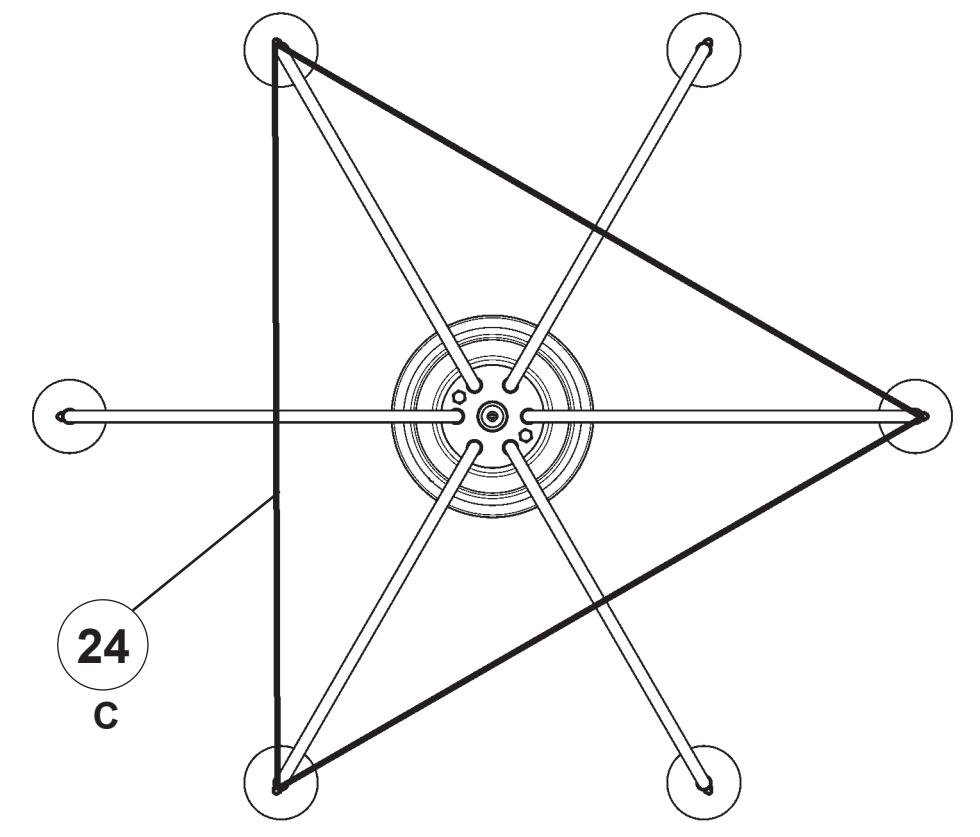

DIAGRAM 2
(BOTTOM VIEW - UPPER TIER ARMS)

