

SARELLA RS83151N-__ __H













10 + 5 Lights
Diameter: 41"
Height: 35"
Hanging Weight: 41lbs.

THIS DESIGN IS THE PROPRIETARY
TRADE DRESS/TRADEMARK OF
W SCHONBEK LLC.

 **SCHONBEK** | 1870

 **SCHONBEK** | 1870

								
MAX 60 W		110-120 V						

WARNING:

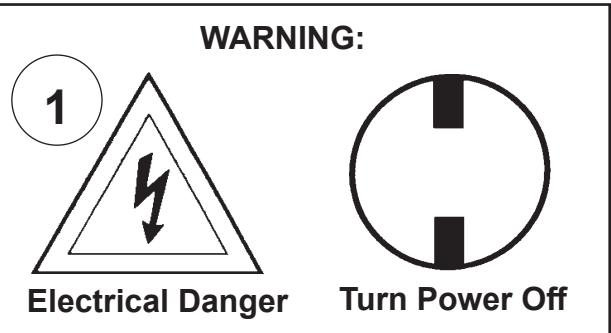
1 

Electrical Danger Turn Power Off

All electrical components must be installed by a licensed electrician in accordance with the National Electric Code and the appropriate local electrical codes.

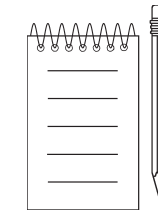
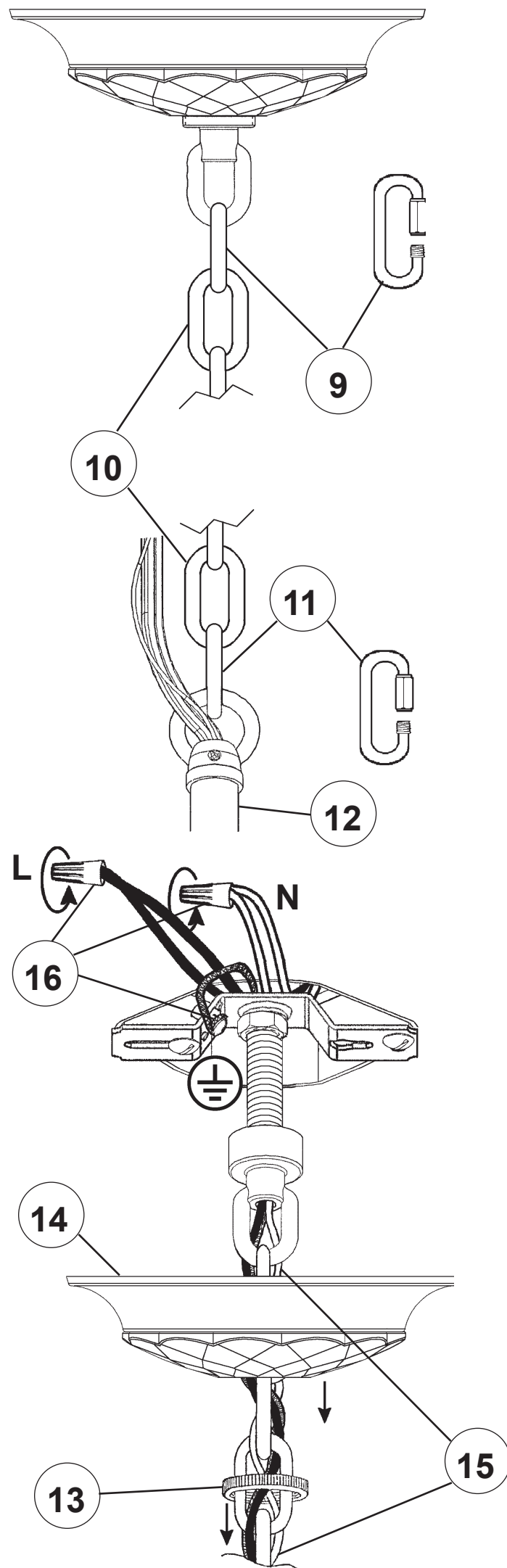
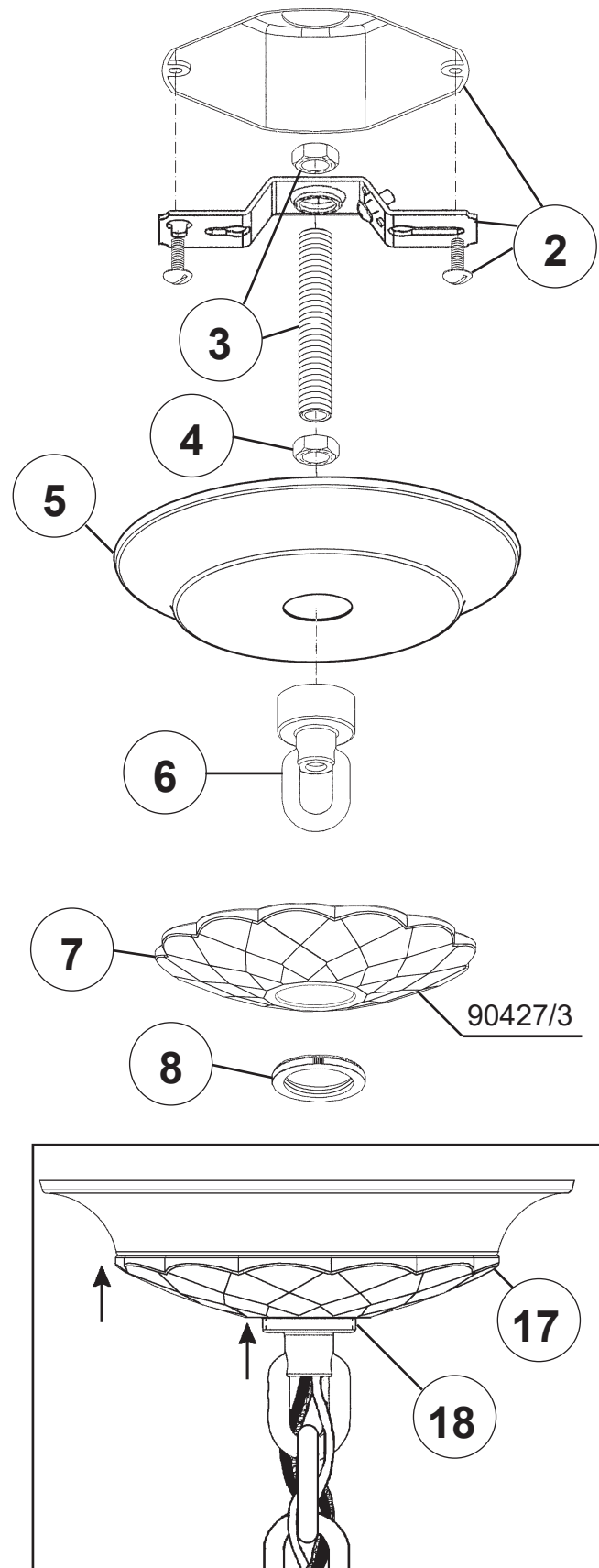

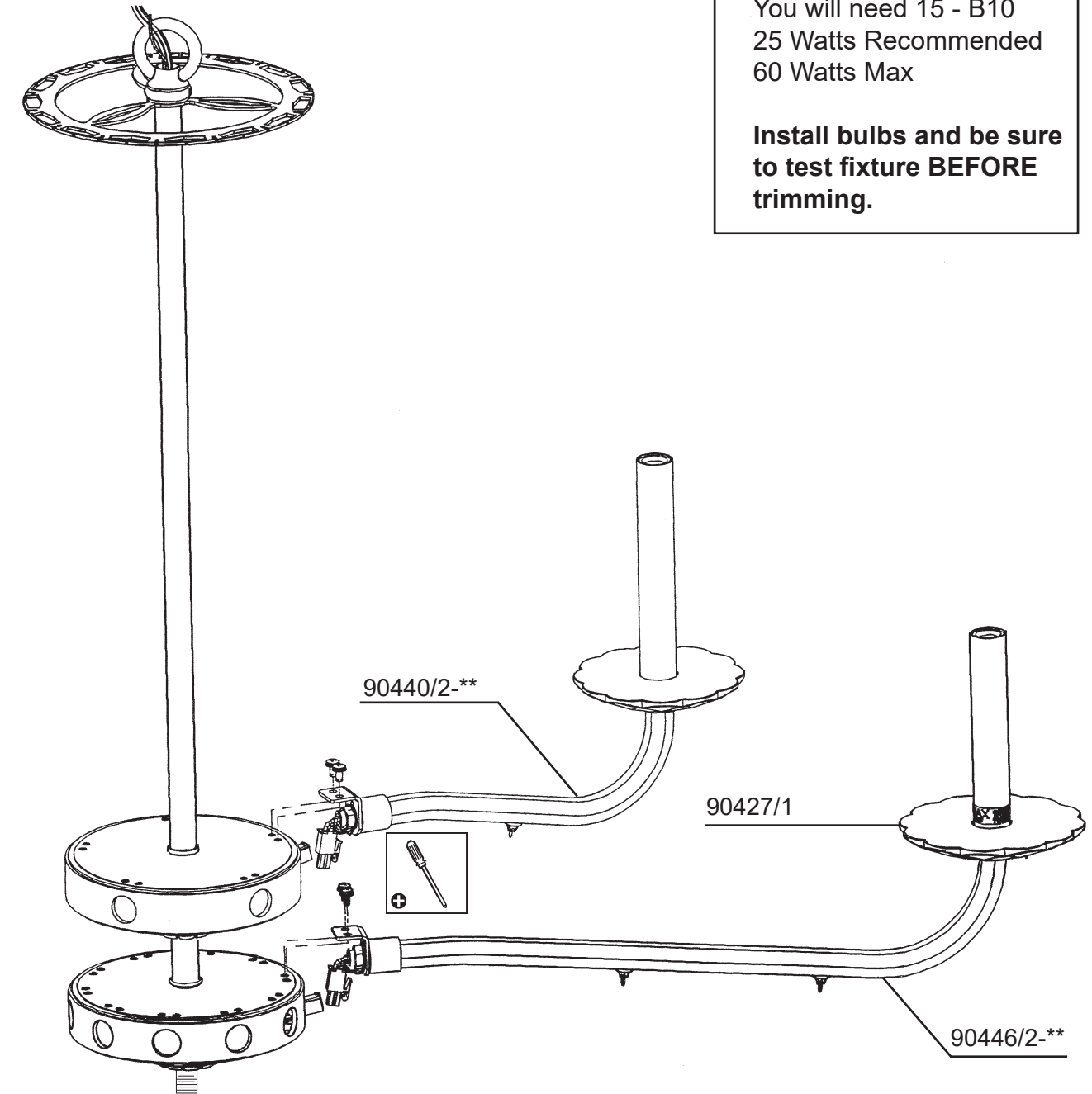
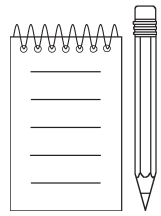

19 Connect arm wires using plug-in connectors on top and bottom tiers. See detailed illustration.



20 Push wires into hole and attach arm into place by tightening screws.

21 Install bobèche on every arm and screw bulbs into all sockets and test fixture before trimming. If any of the bulbs do NOT light - DISCONNECT POWER. Double check the wire connections.

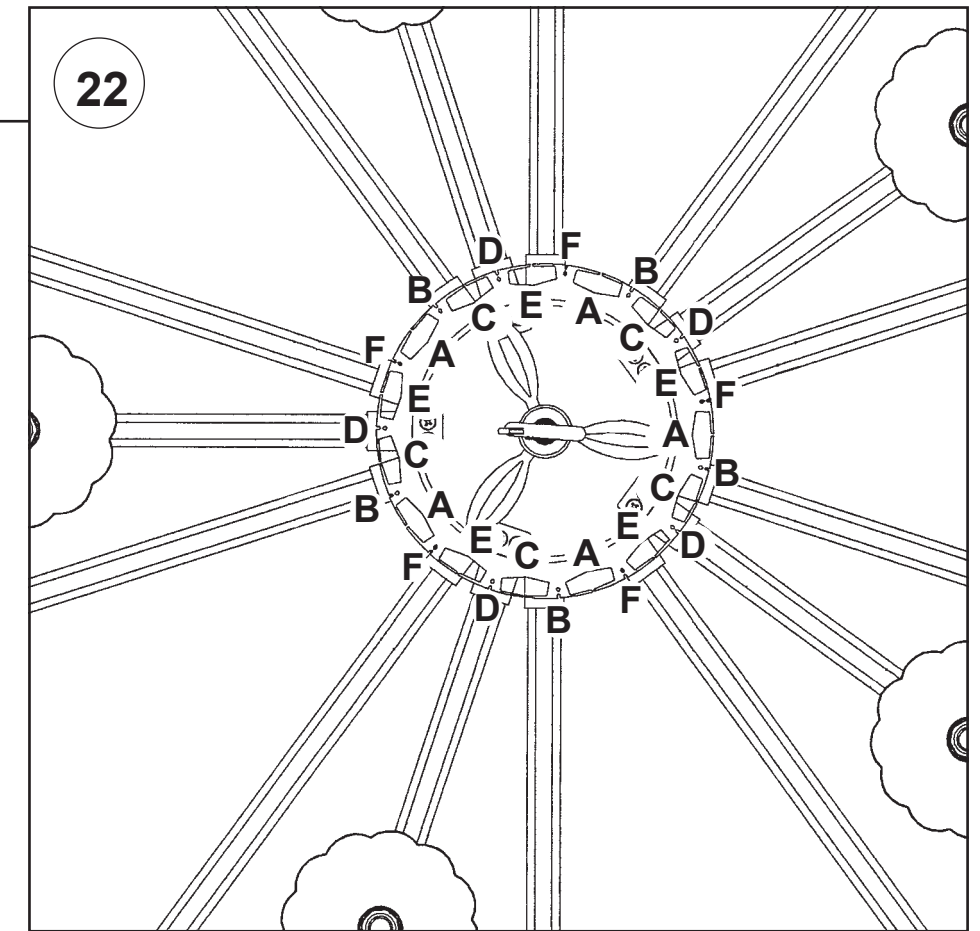
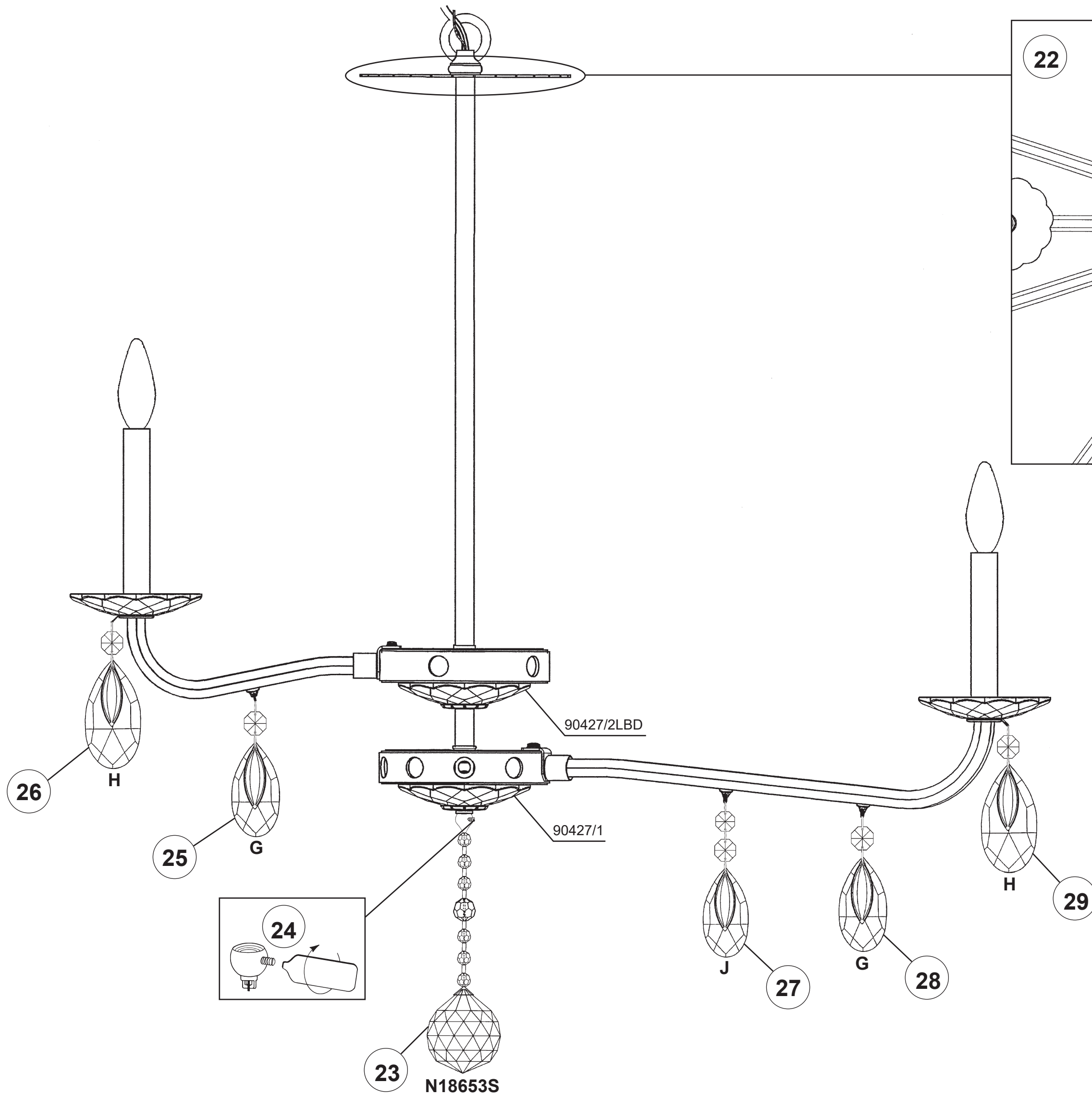

SARELLA RS83151N-__ __R













10 + 5 Lights
Diameter: 41"
Height: 35"
Hanging Weight: 41lbs.

THIS DESIGN IS THE PROPRIETARY
TRADE DRESS/TRADEMARK OF
W SCHONBEK LLC.

 **SCHONBEK** | 1870

 **SCHONBEK** | 1870

								
MAX 60 W	110-120 V							

WARNING:

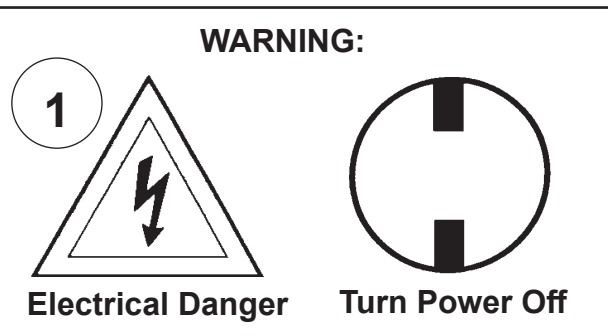
1 

Electrical Danger Turn Power Off

All electrical components must be installed by a licensed electrician in accordance with the National Electric Code and the appropriate local electrical codes.

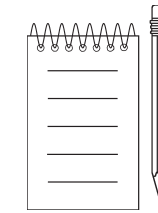
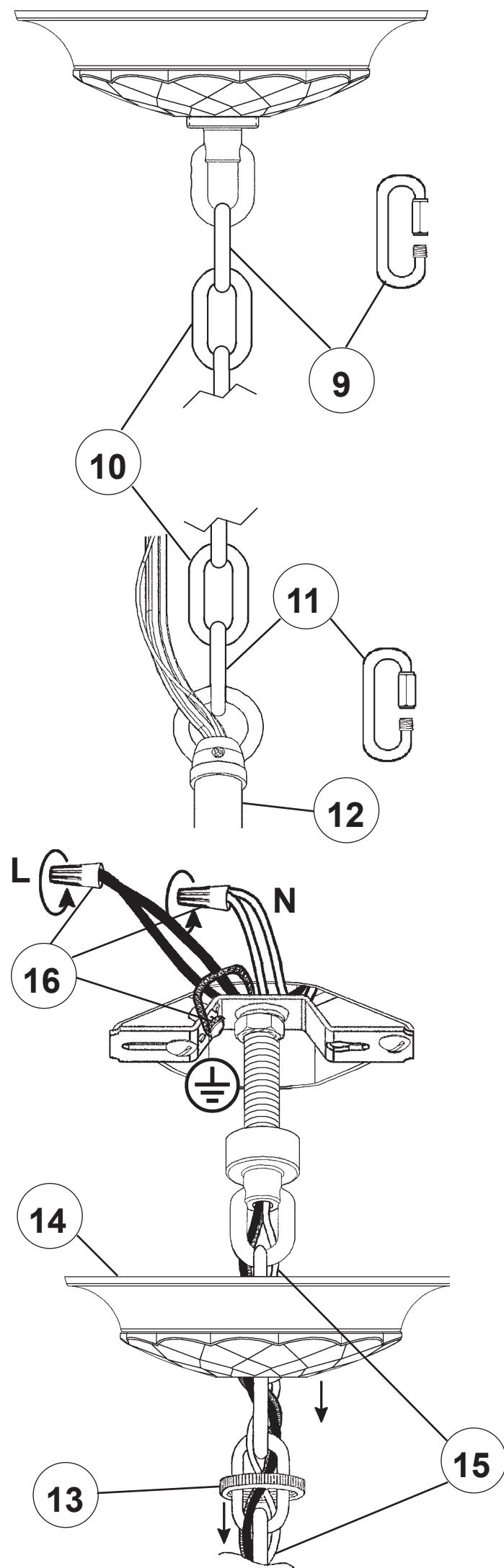
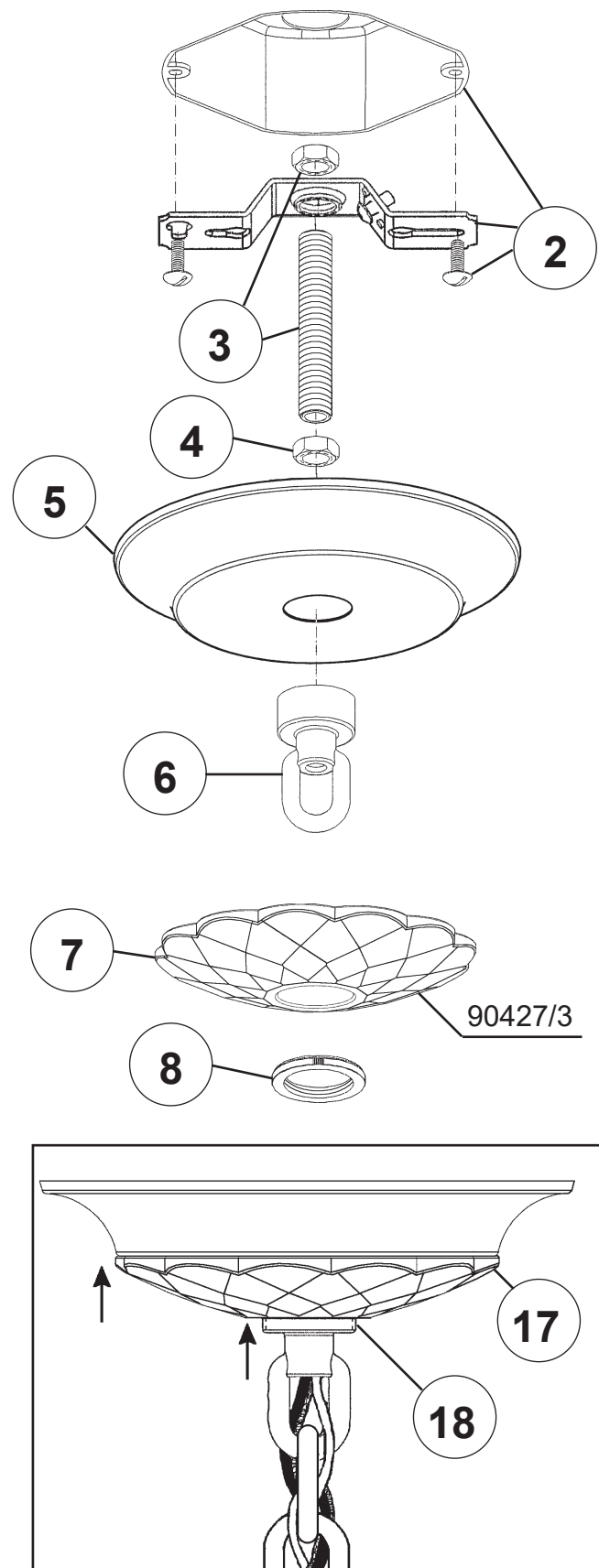

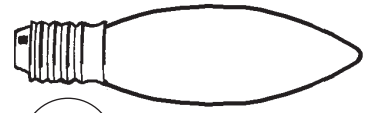
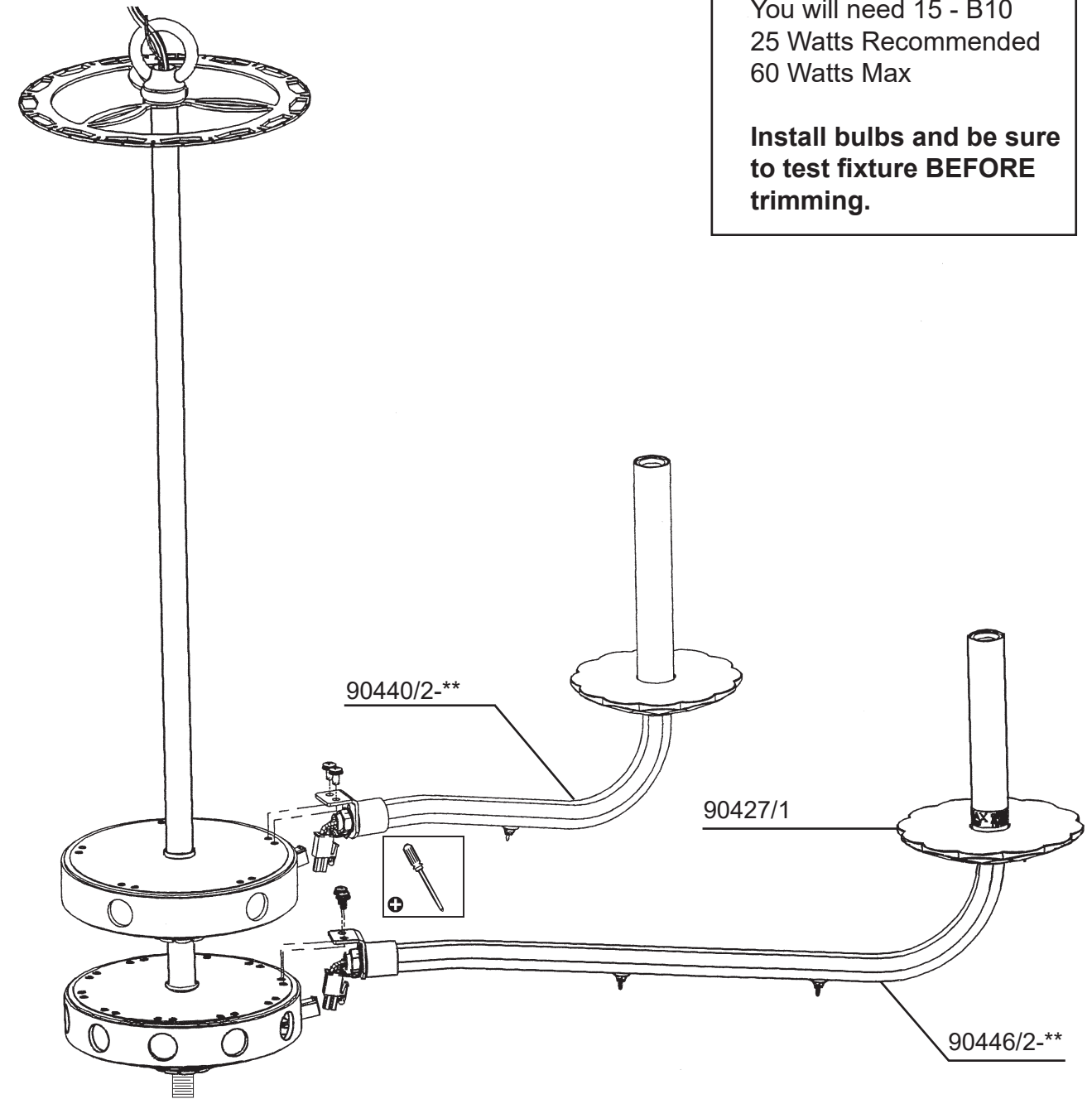
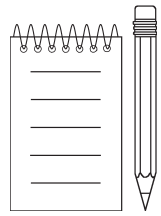

21

You will need 15 - B10
25 Watts Recommended
60 Watts Max

**Install bulbs and be sure
to test fixture BEFORE
trimming.**

19 Connect arm wires using plug-in connectors on top and bottom tiers. See detailed illustration.

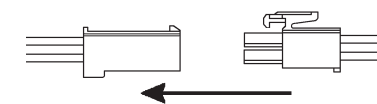

20 Push wires into hole and attach arm into place by tightening screws.

21 Install bobèche on every arm and screw bulbs into all sockets and test fixture before trimming. If any of the bulbs do NOT light - DISCONNECT POWER. Double check the wire connections.

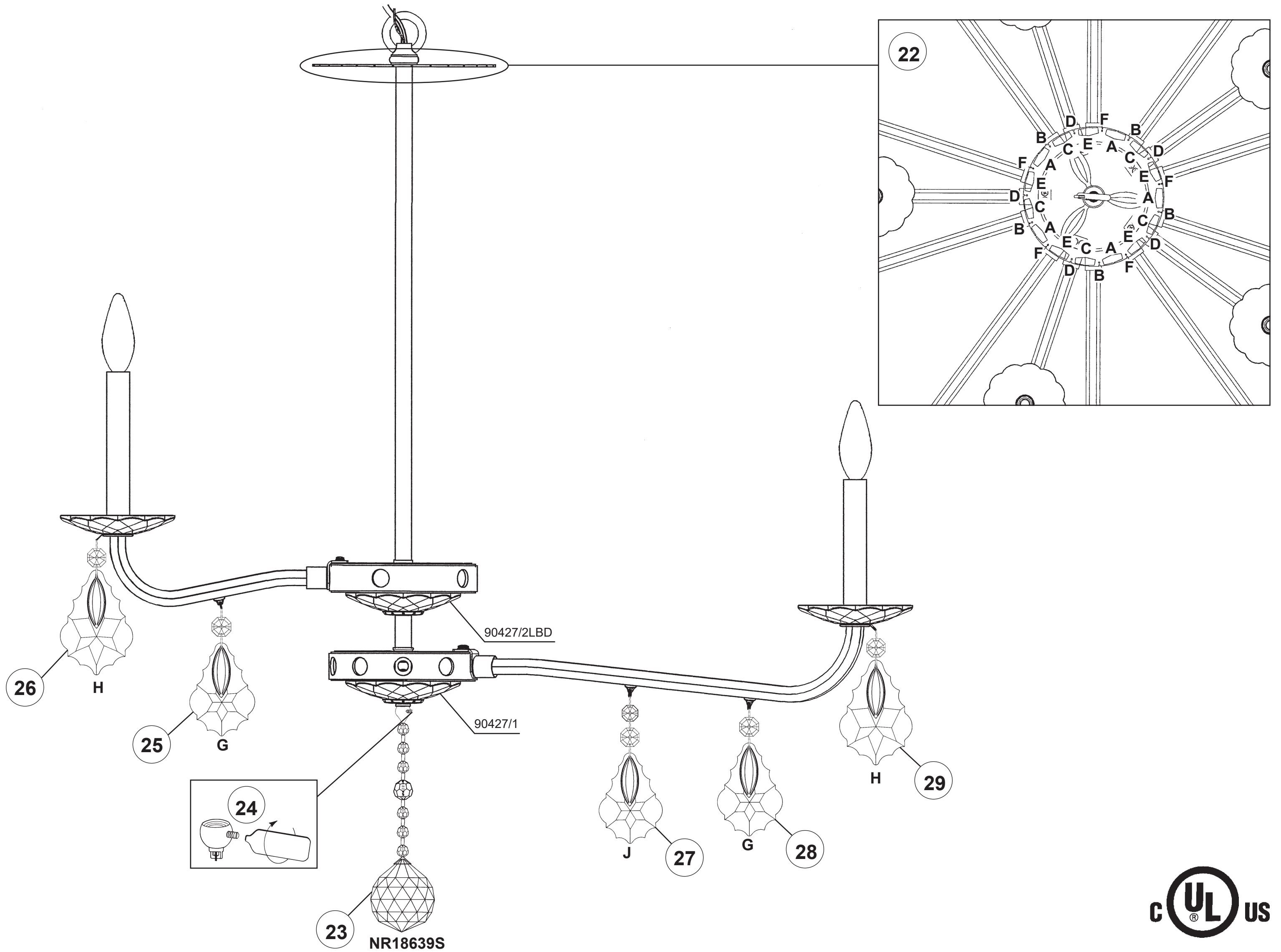

SARELLA RS83151N-__ __S













10 + 5 Lights
Diameter: 41"
Height: 35"
Hanging Weight: 41lbs.

THIS DESIGN IS THE PROPRIETARY
TRADE DRESS/TRADEMARK OF
W SCHONBEK LLC.

 **SCHONBEK** | 1870

 **SCHONBEK** | 1870

								
MAX 60 W	110-120 V							

WARNING:

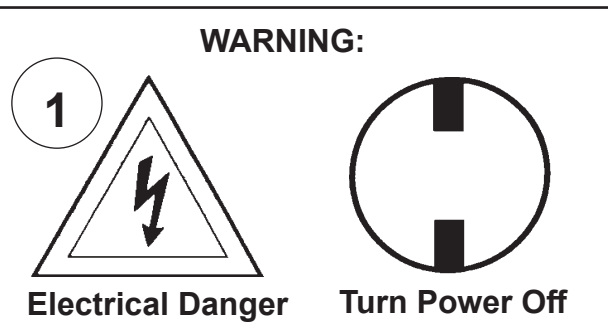
1 

Electrical Danger Turn Power Off

All electrical components must be installed by a licensed electrician in accordance with the National Electric Code and the appropriate local electrical codes.

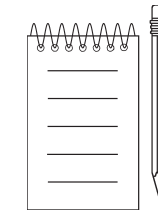
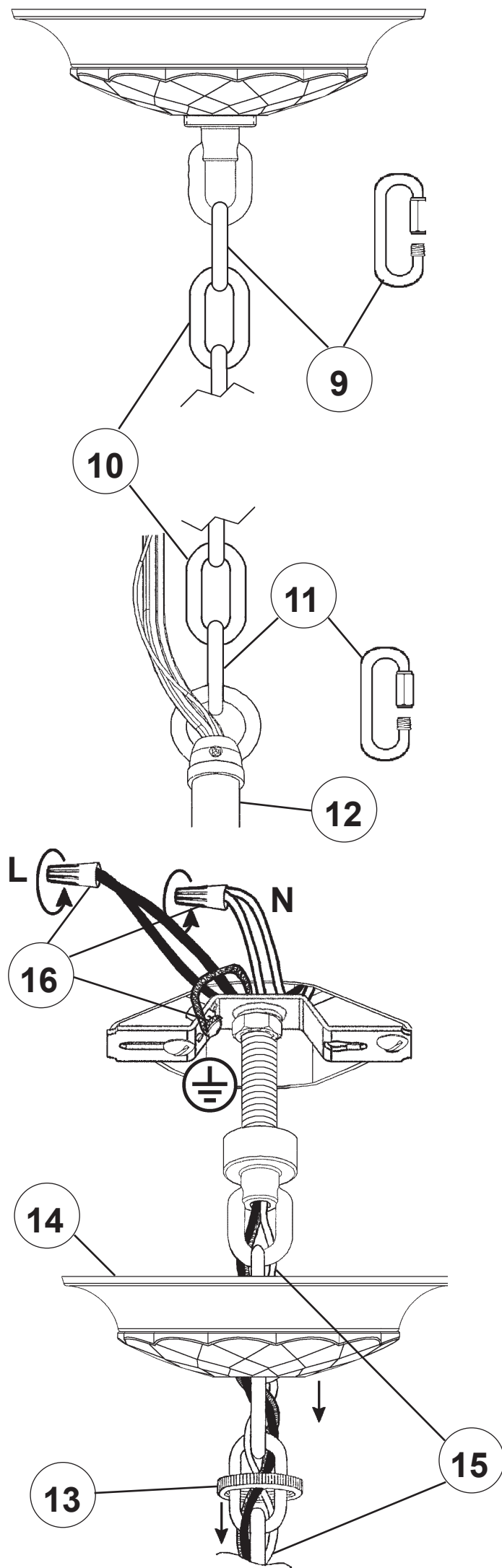
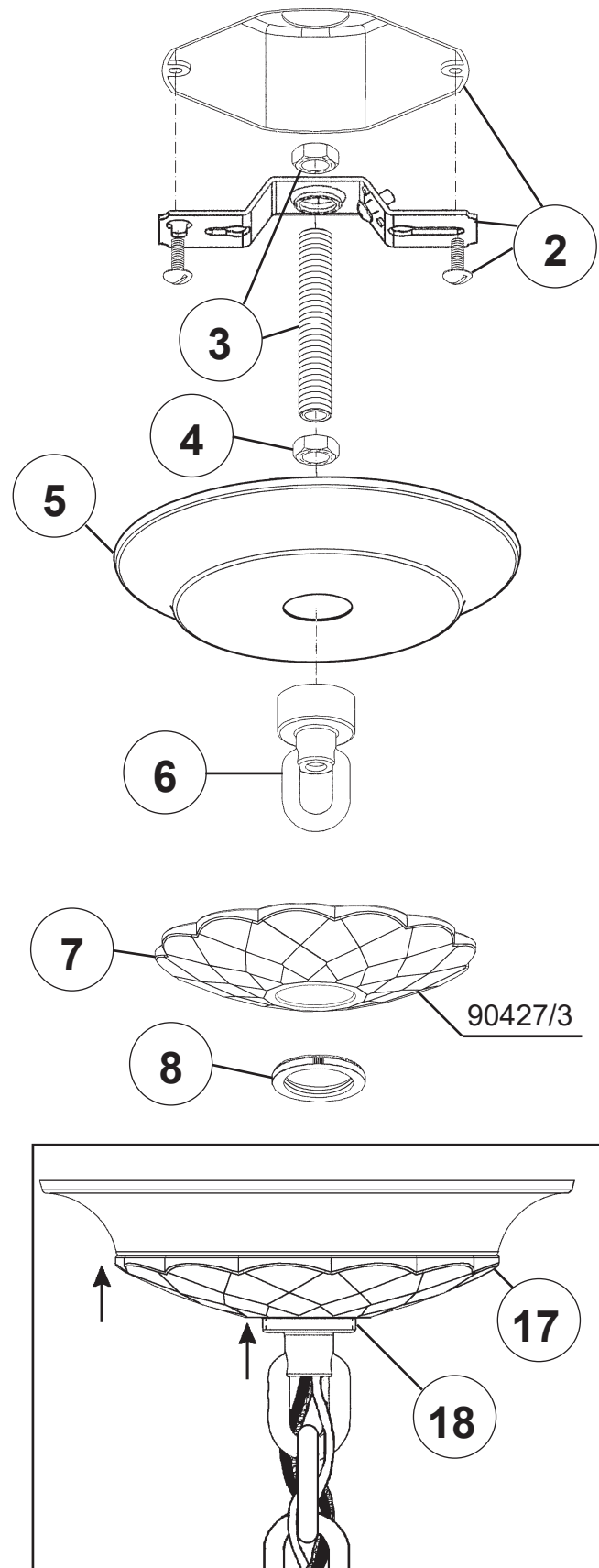

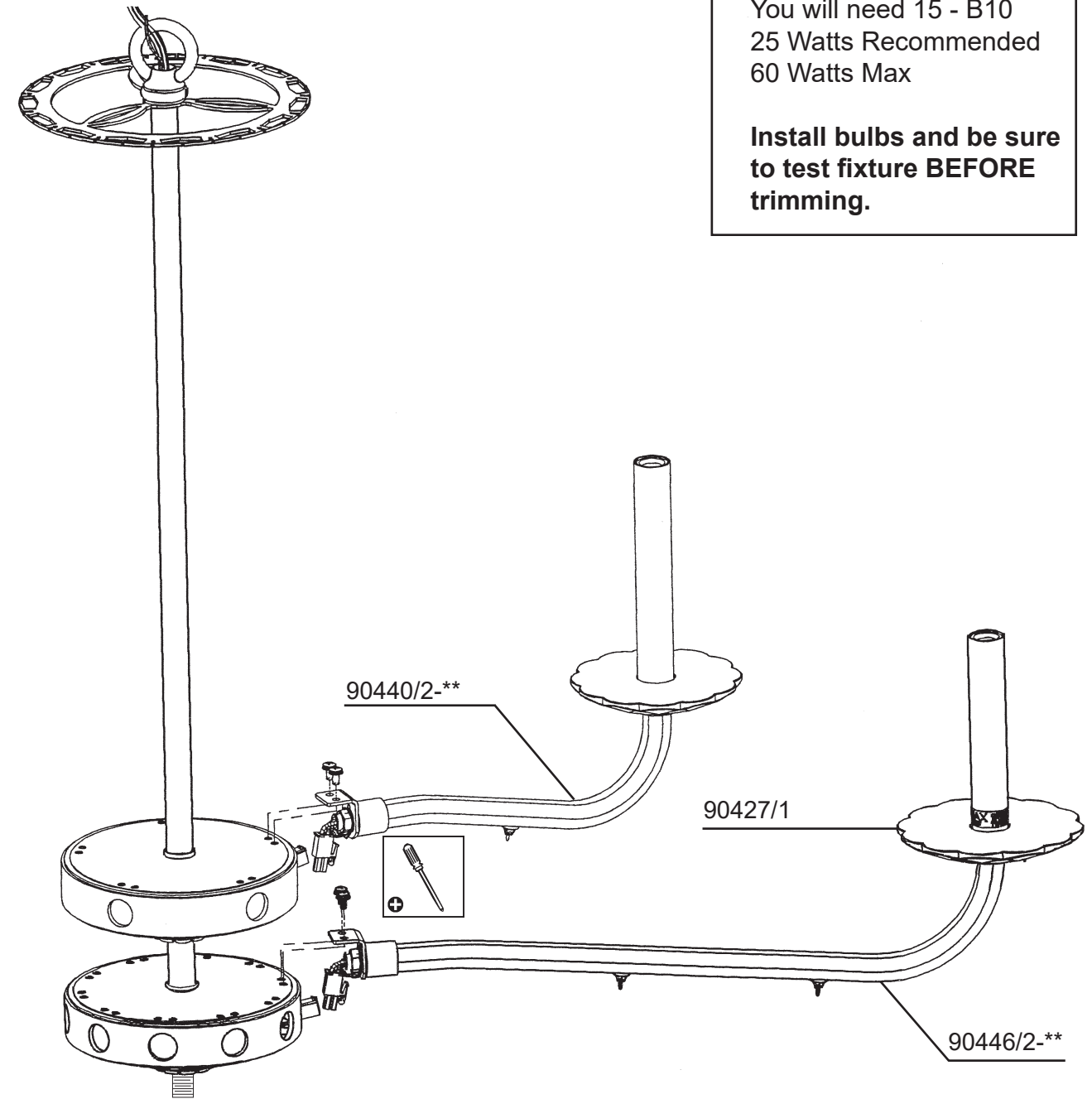
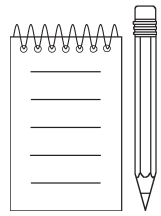

19 Connect arm wires using plug-in connectors on top and bottom tiers. See detailed illustration.

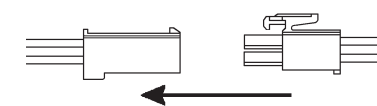

20 Push wires into hole and attach arm into place by tightening screws.

21 Install bobèche on every arm and screw bulbs into all sockets and test fixture before trimming. If any of the bulbs do NOT light - DISCONNECT POWER. Double check the wire connections.

