

SARELLA RS8332N-__ __H

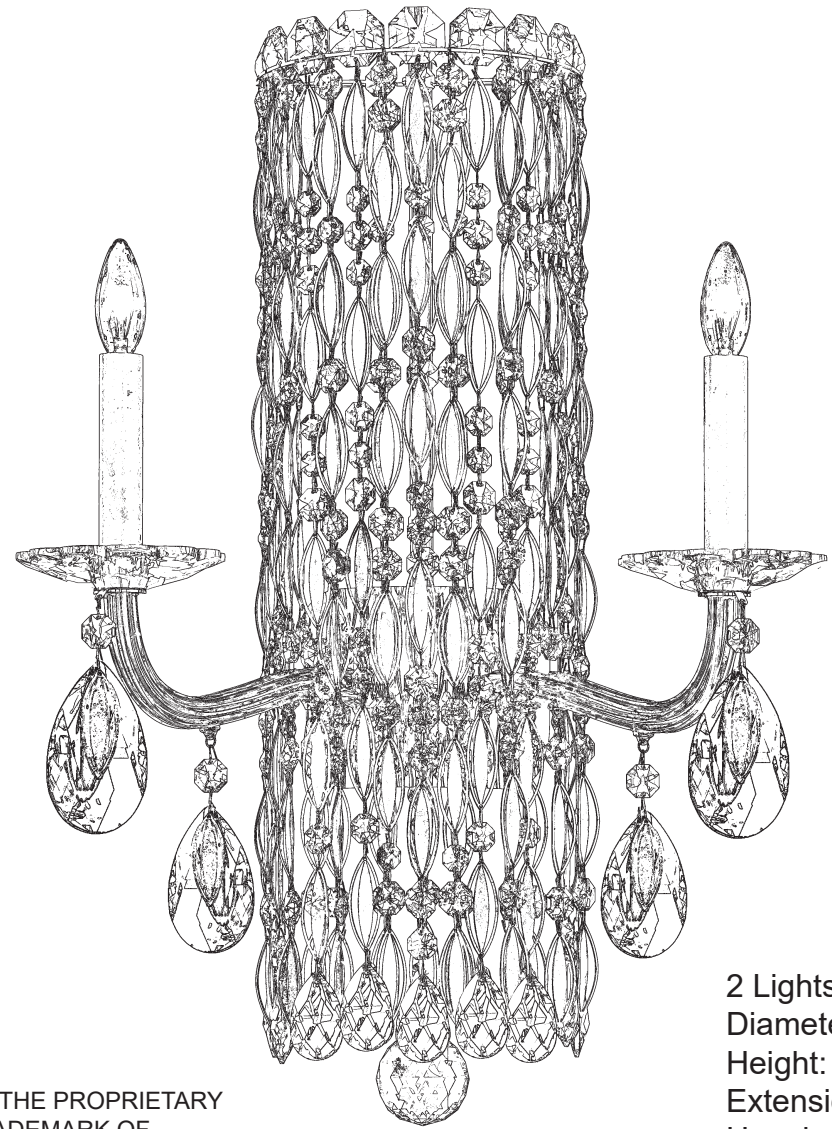











2 Lights
Diameter: 16"
Height: 23"
Extension: 10"
Hanging Weight: 7lbs.

THIS DESIGN IS THE PROPRIETARY
TRADE DRESS/TRADEMARK OF
W SCHONBEK LLC.

 **SCHONBEK** | 1870

 **SCHONBEK** | 1870

								
MAX <u>60</u> W	110-120 V							

1 X  : 416/1S

1 X  : 100/1S

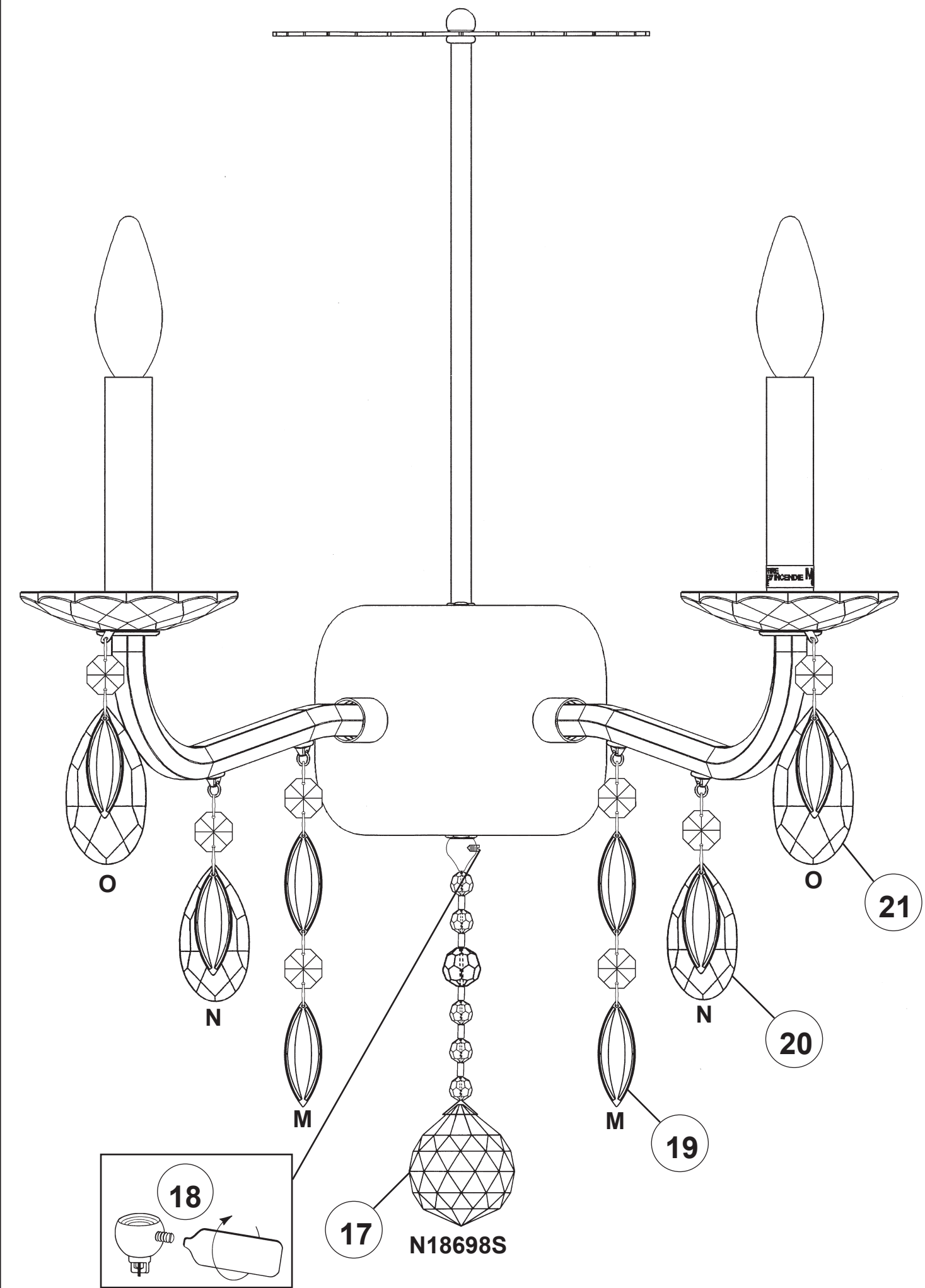
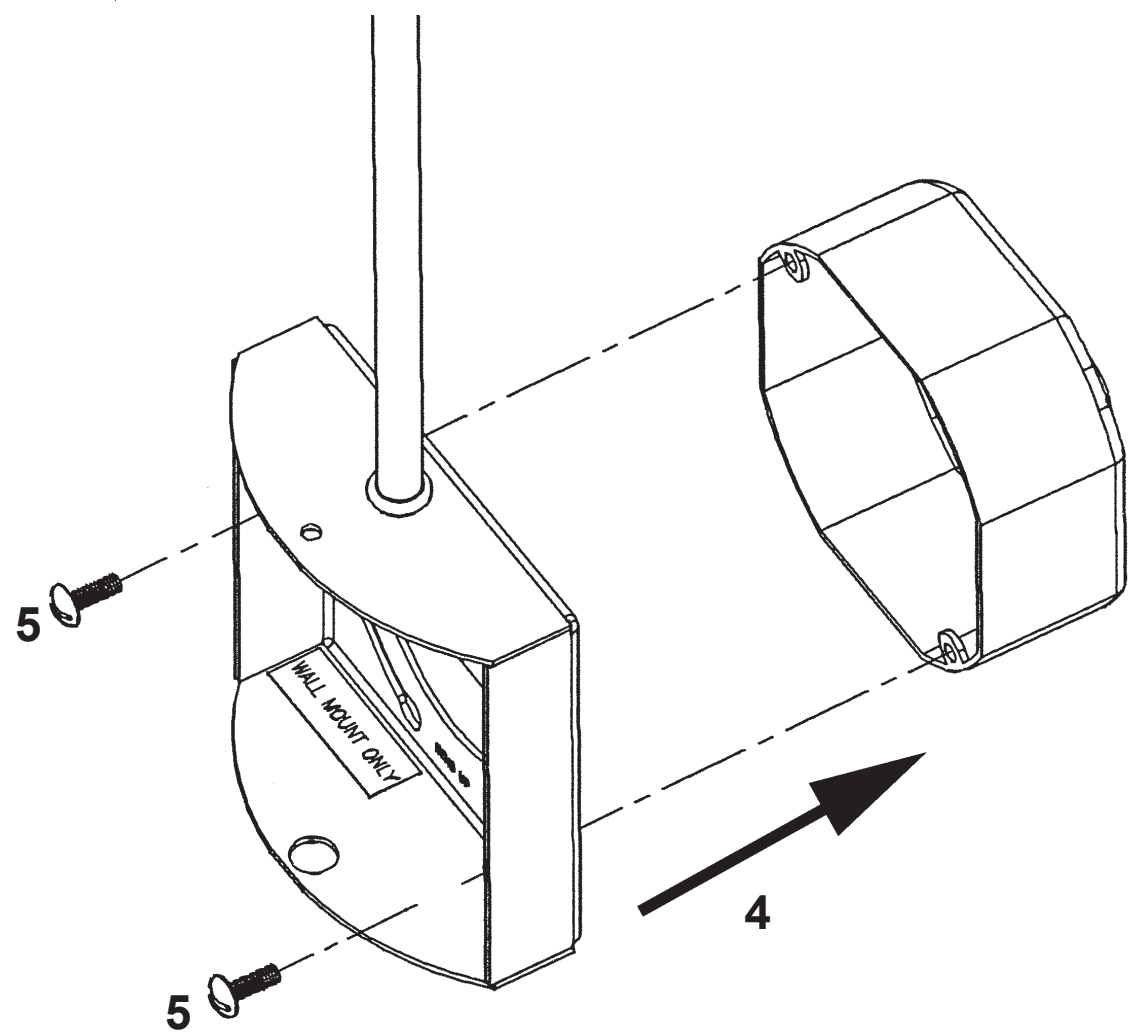
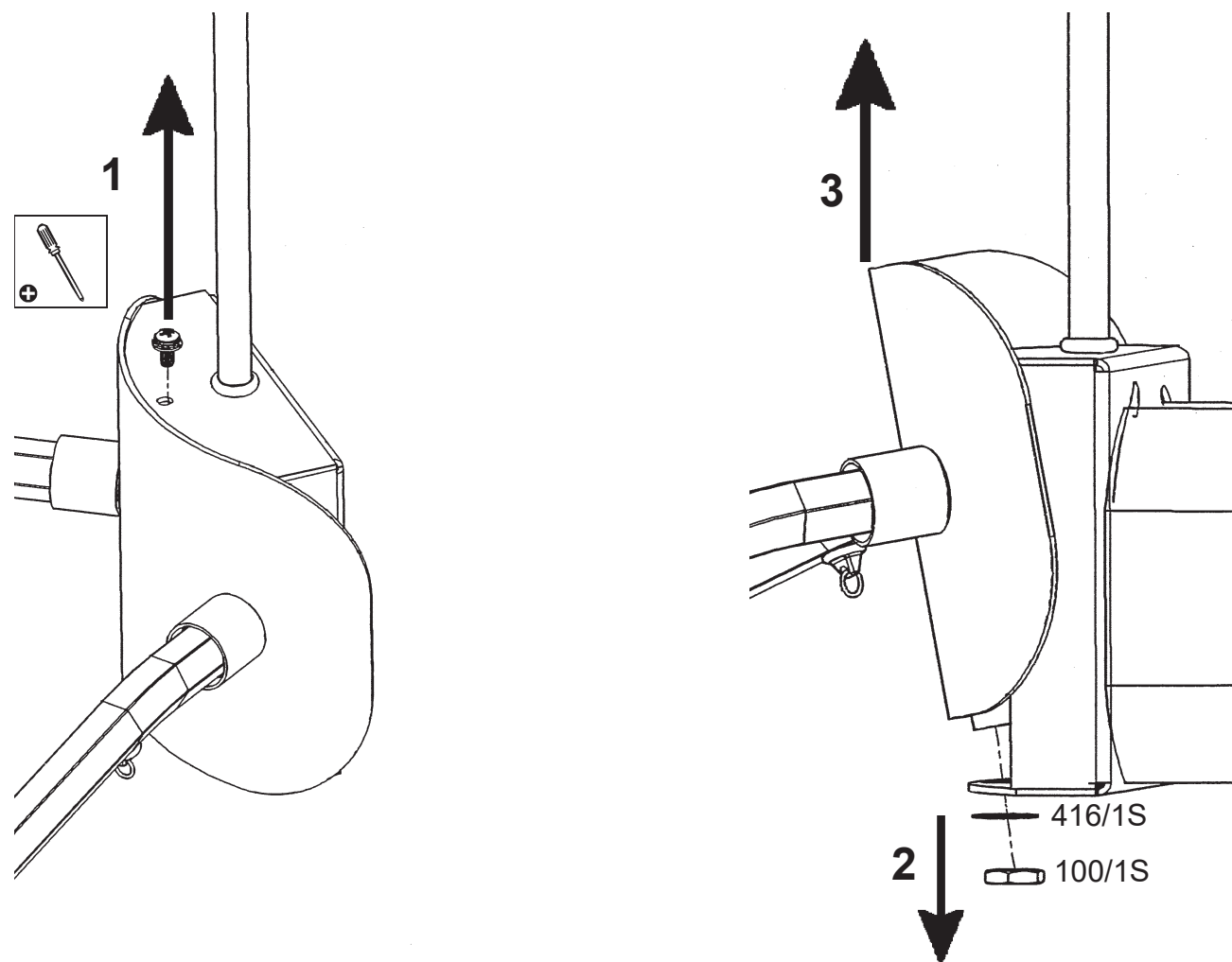

16

TRIM PLATE - TOP VIEW

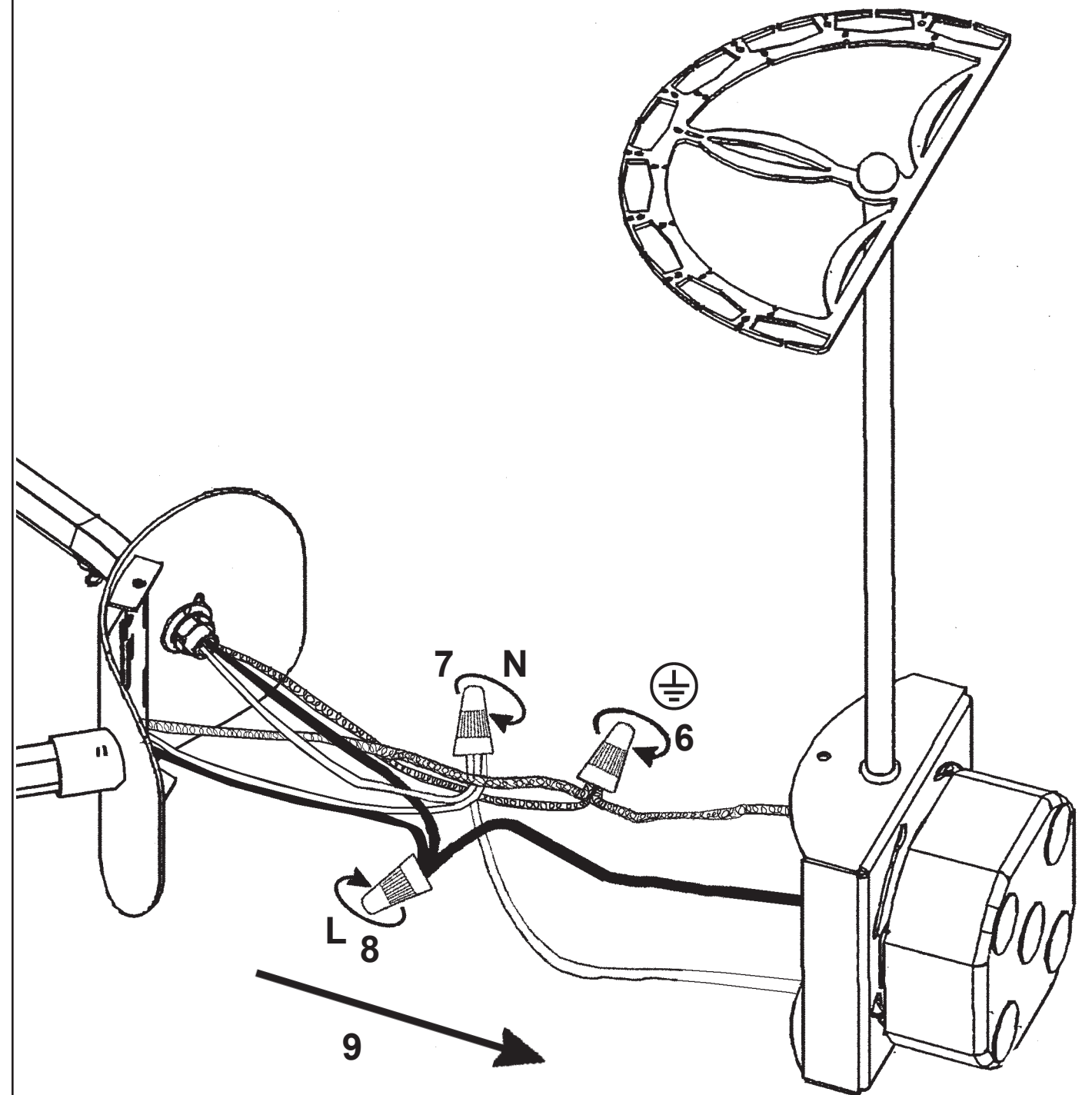
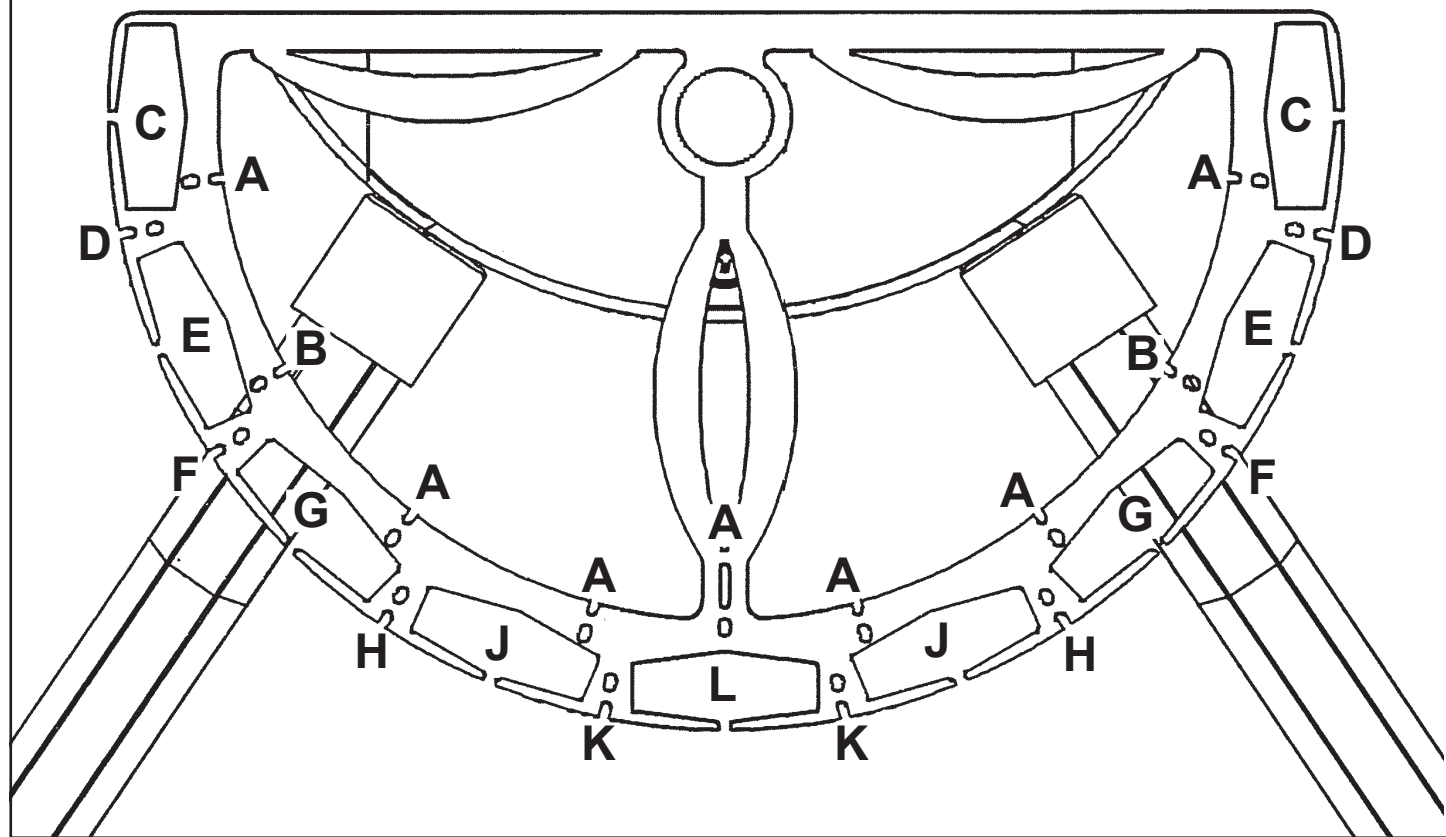

1 X  : 416/1S

1 X  : 100/1S

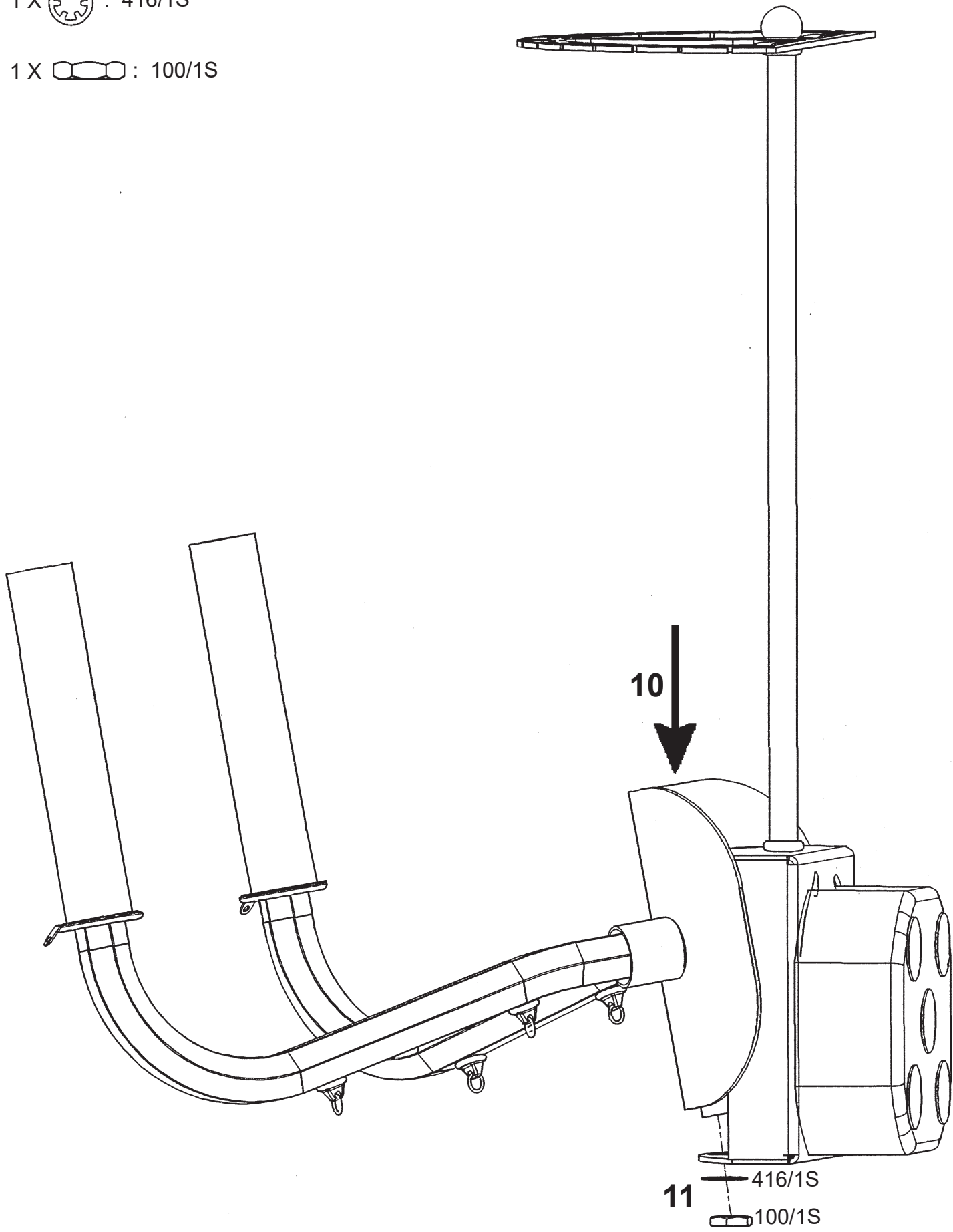

15



You will need 2 - B10
25 Watts Recommended
60 Watts Max

Install bulbs and be sure
to test fixture **BEFORE**
trimming.

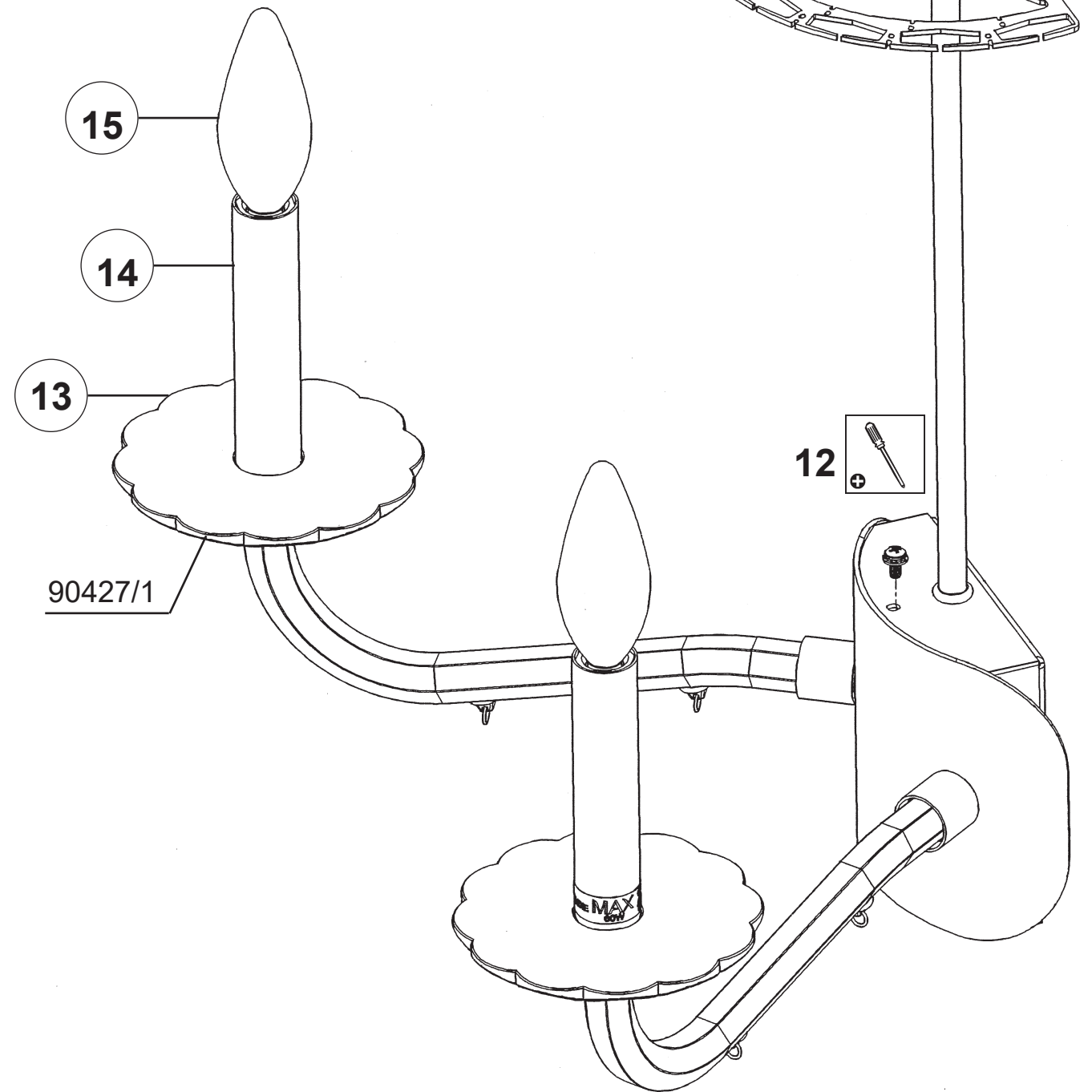

SARELLA RS8332N-__ __R

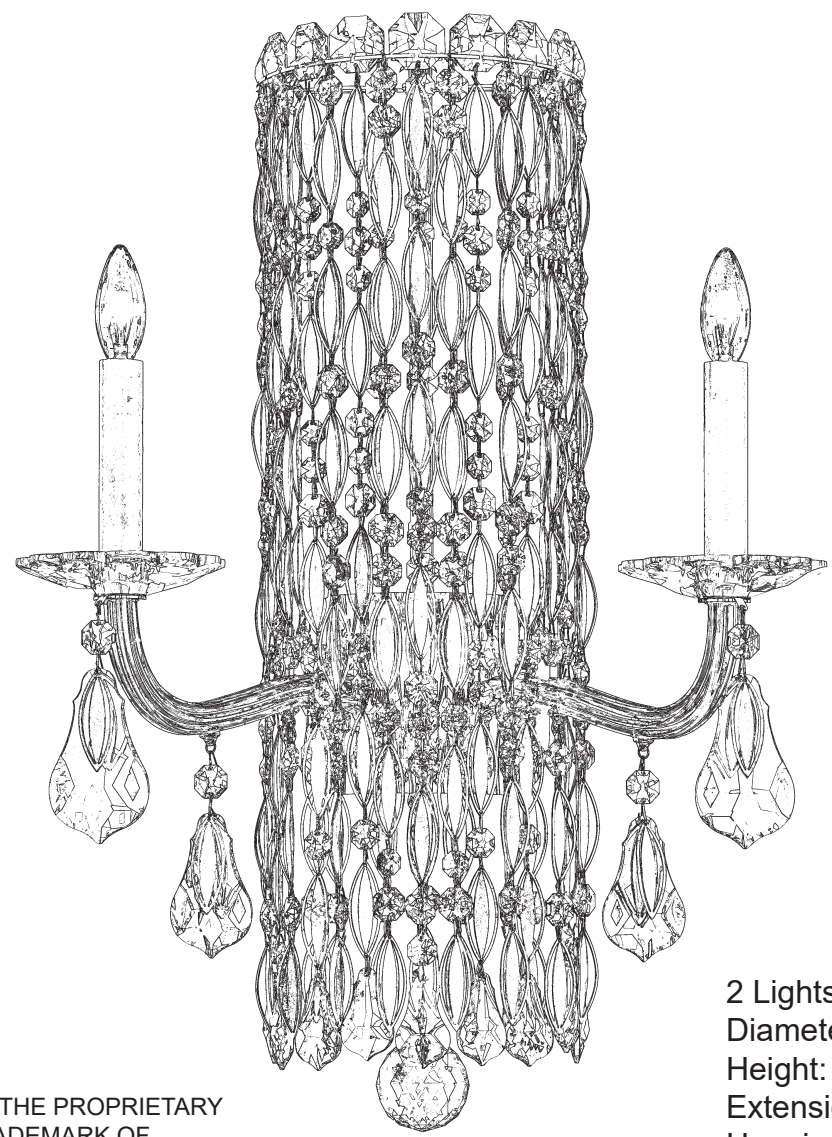











2 Lights
Diameter: 16"
Height: 23"
Extension: 10"
Hanging Weight: 7lbs.

THIS DESIGN IS THE PROPRIETARY
TRADE DRESS/TRADEMARK OF
W SCHONBEK LLC.

 **SCHONBEK** | 1870

 **SCHONBEK** | 1870

								
MAX <u>60</u> W		110-120 V						

1 X  : 416/1S

1 X  : 100/1S

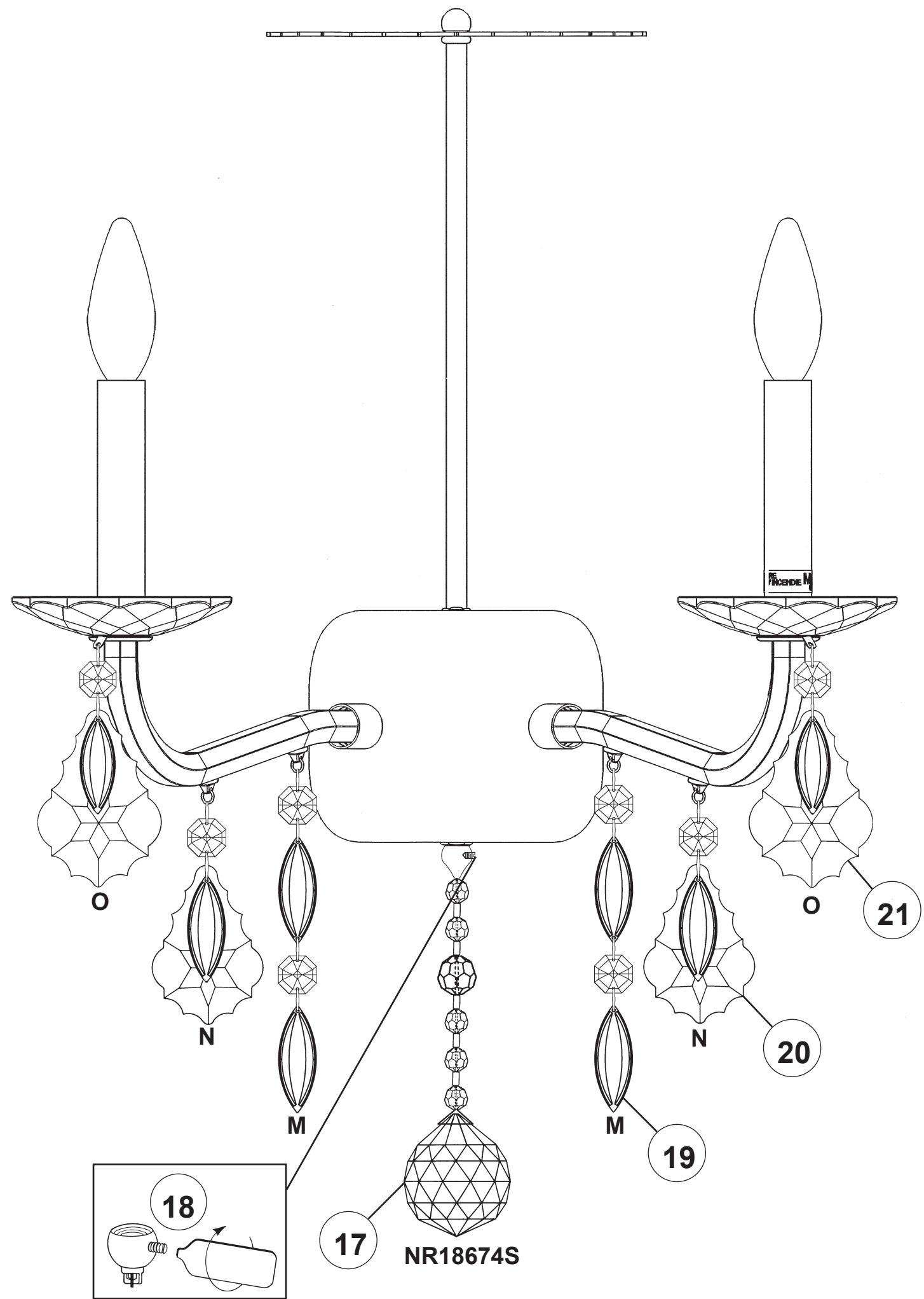
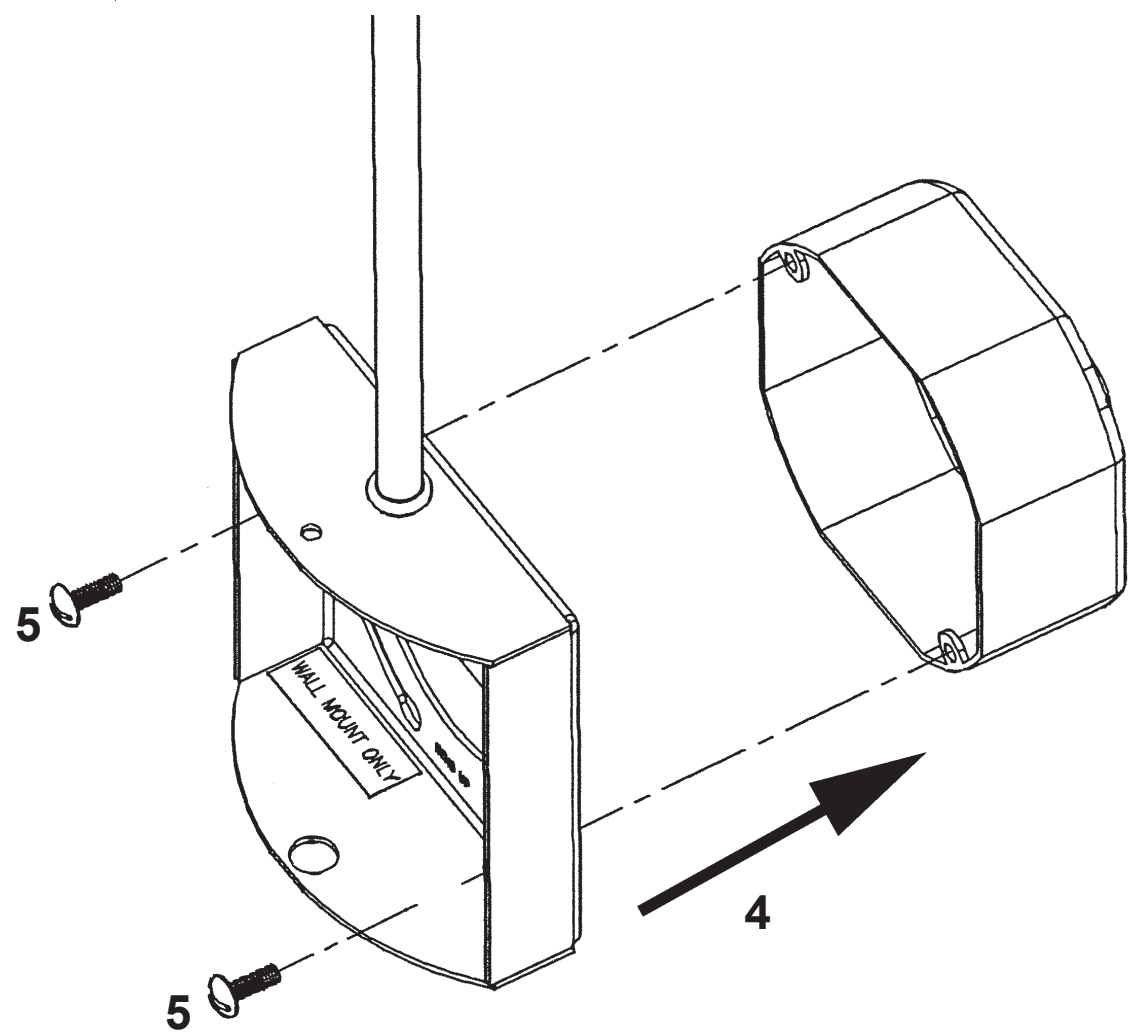
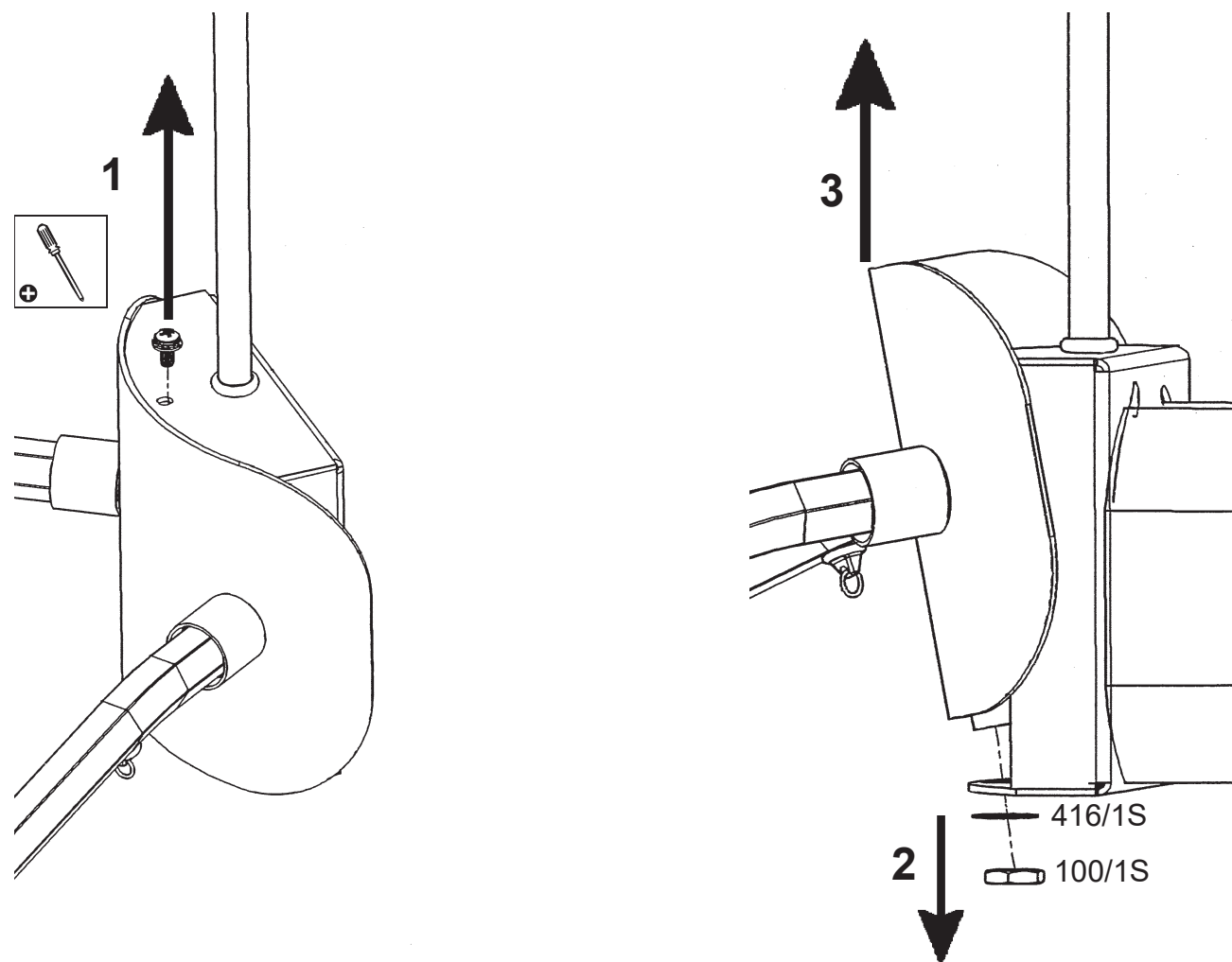

16

TRIM PLATE - TOP VIEW

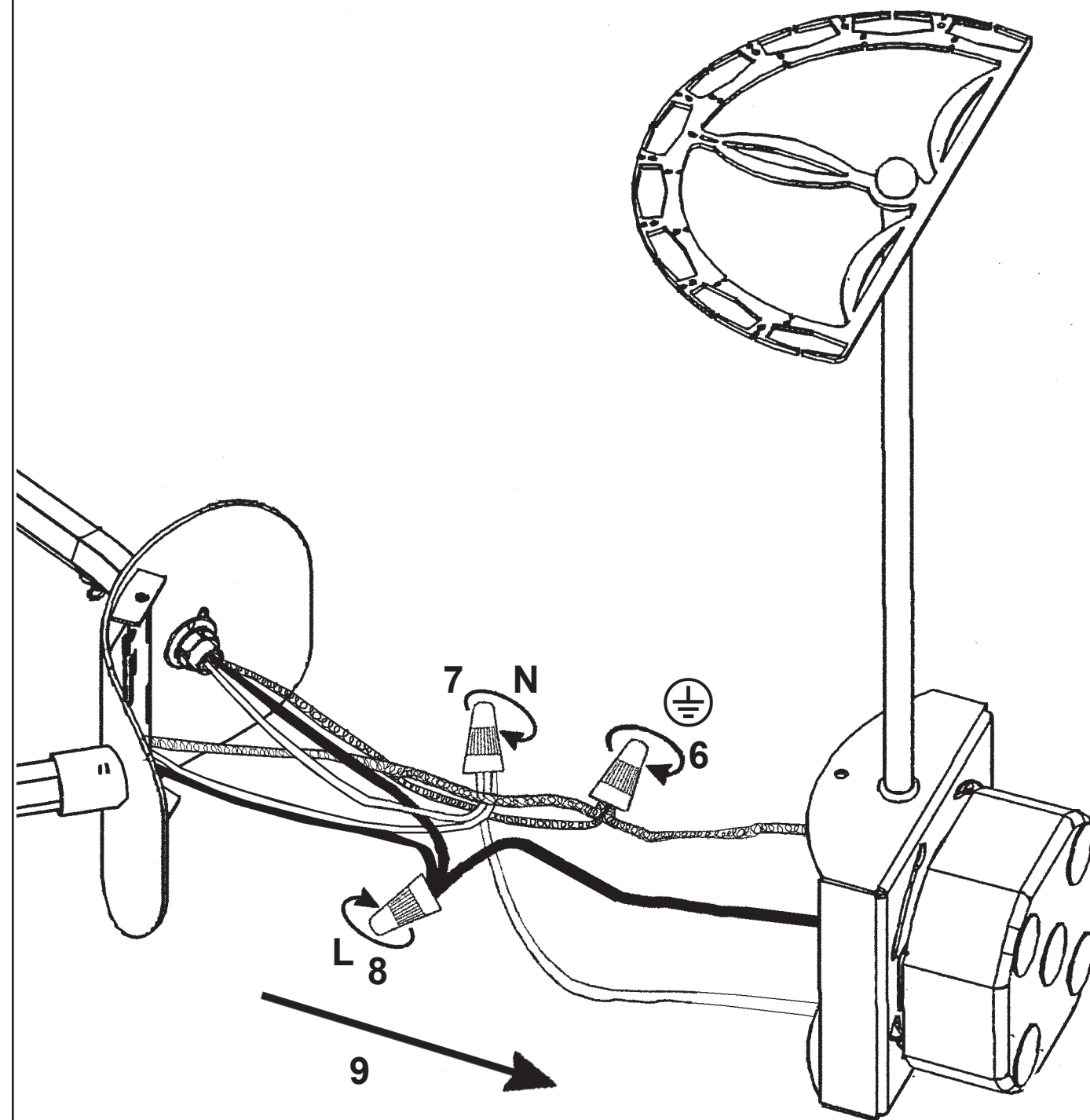
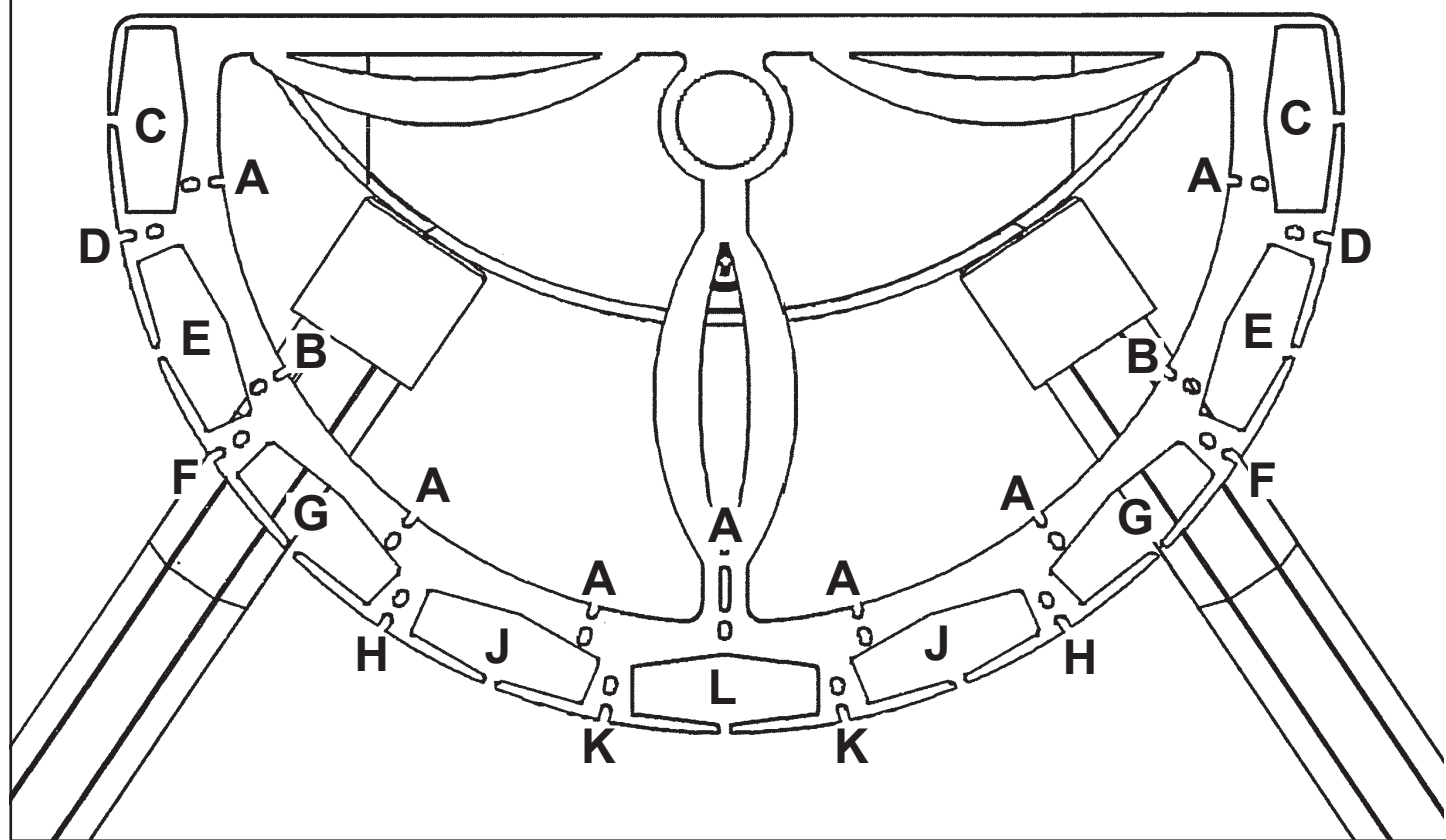

1 X  : 416/1S

1 X  : 100/1S

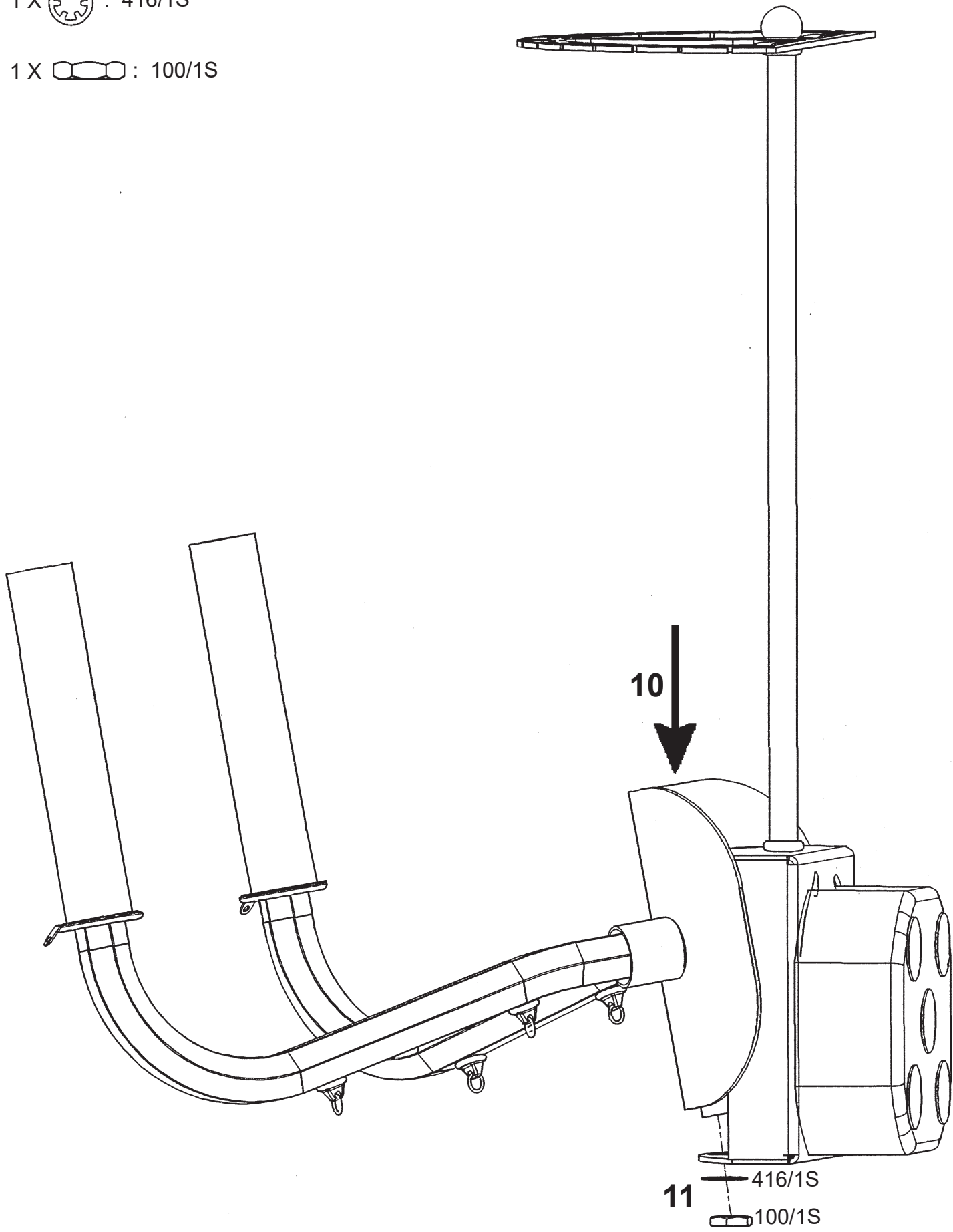

15



You will need 2 - B10
25 Watts Recommended
60 Watts Max

Install bulbs and be sure
to test fixture **BEFORE**
trimming.

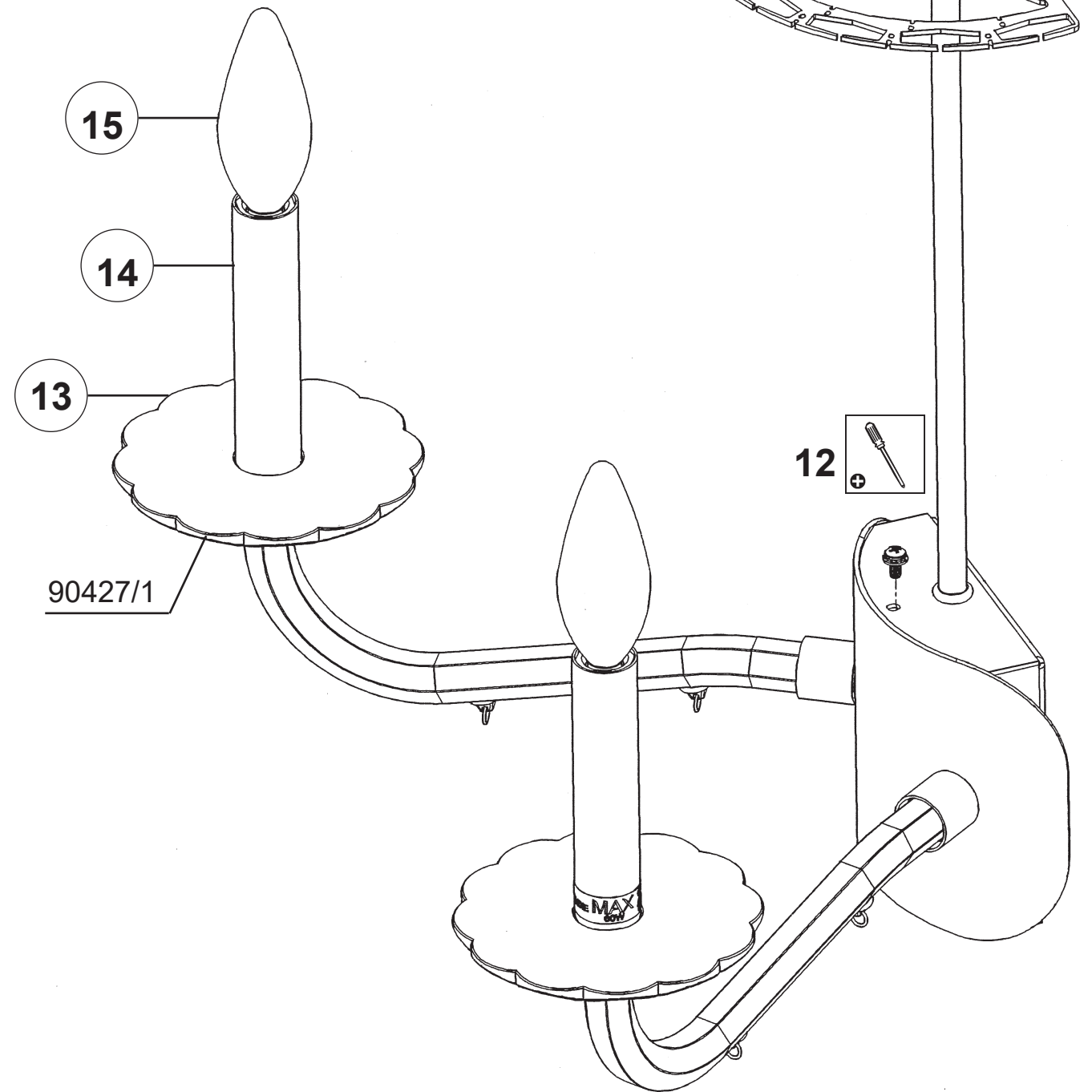

SARELLA RS8332N-__ __S

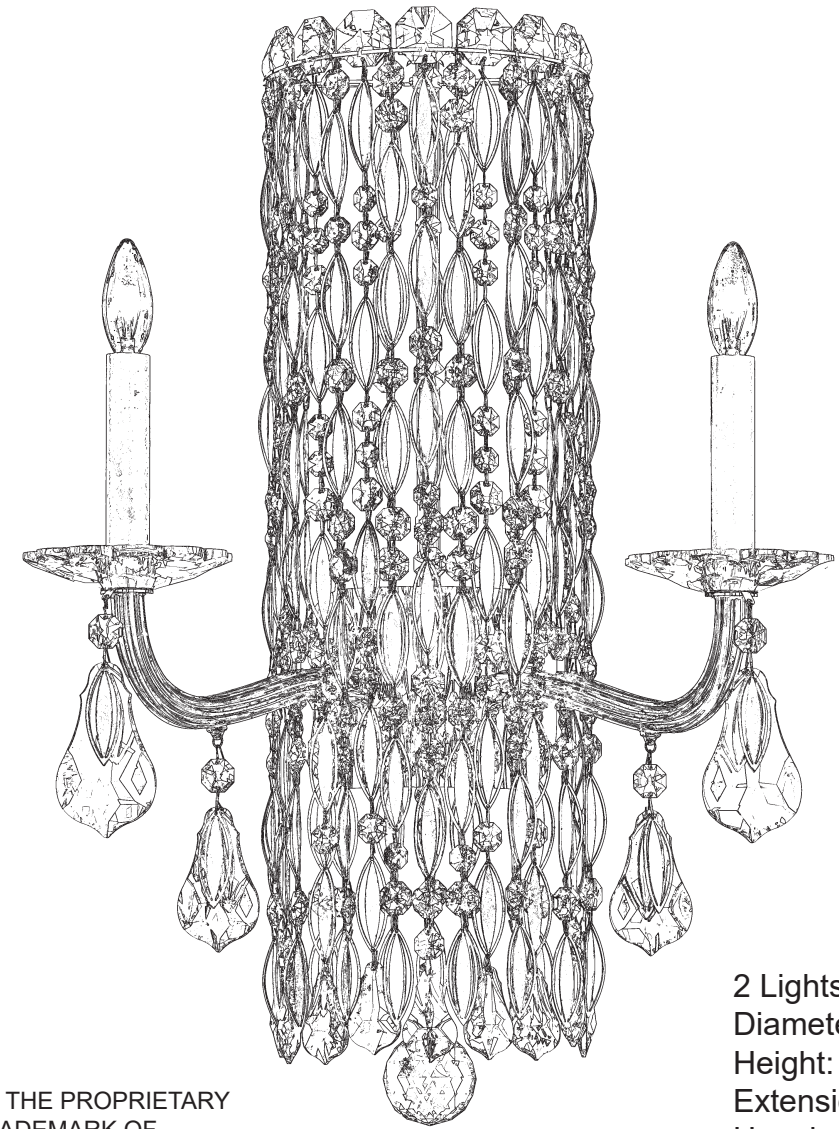











2 Lights
Diameter: 16"
Height: 23"
Extension: 10"
Hanging Weight: 7lbs.

THIS DESIGN IS THE PROPRIETARY
TRADE DRESS/TRADEMARK OF
W SCHONBEK LLC.

 **SCHONBEK** | 1870

 **SCHONBEK** | 1870

								
MAX <u>60</u> W	110-120 V							

1 X  : 416/1S

1 X  : 100/1S

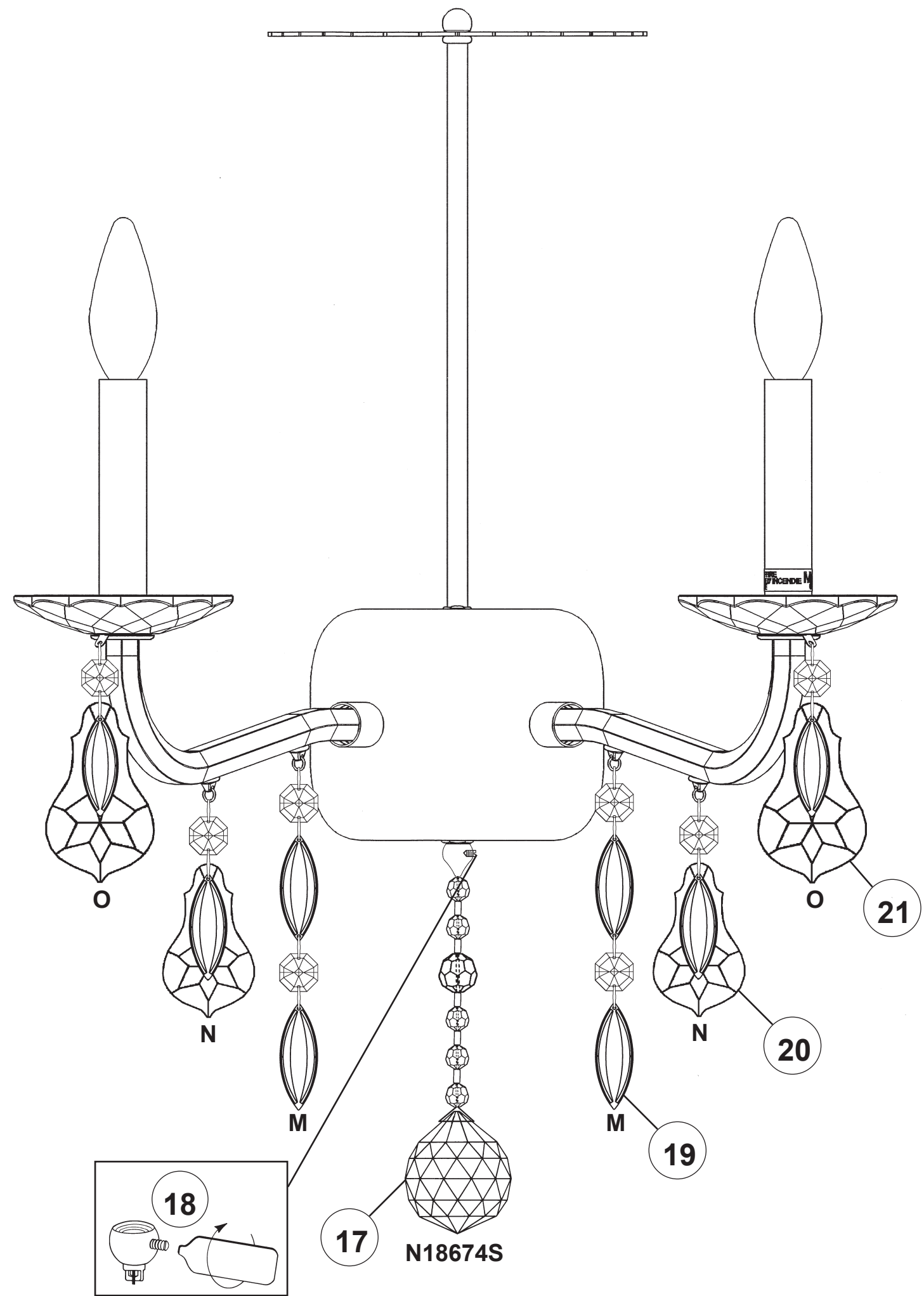
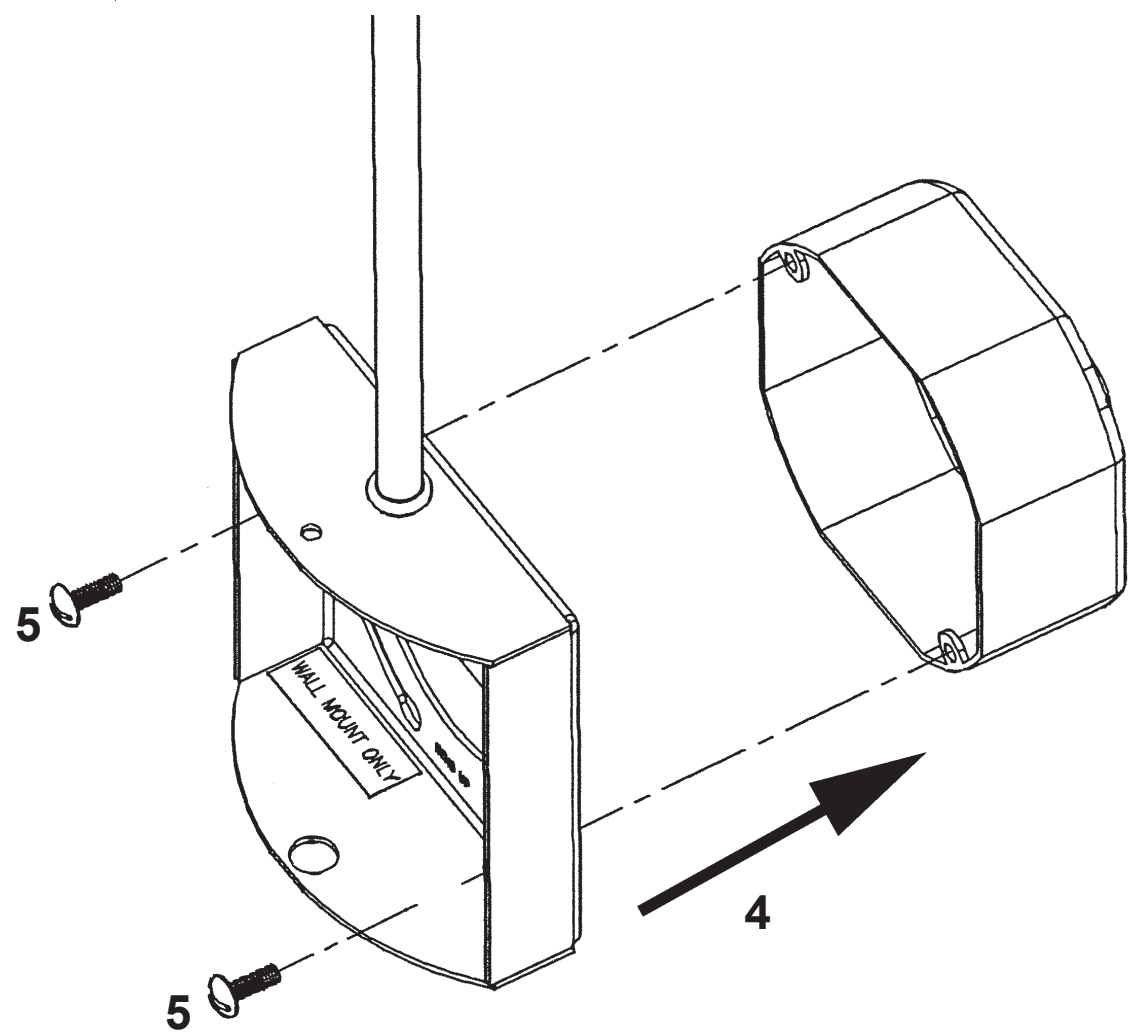
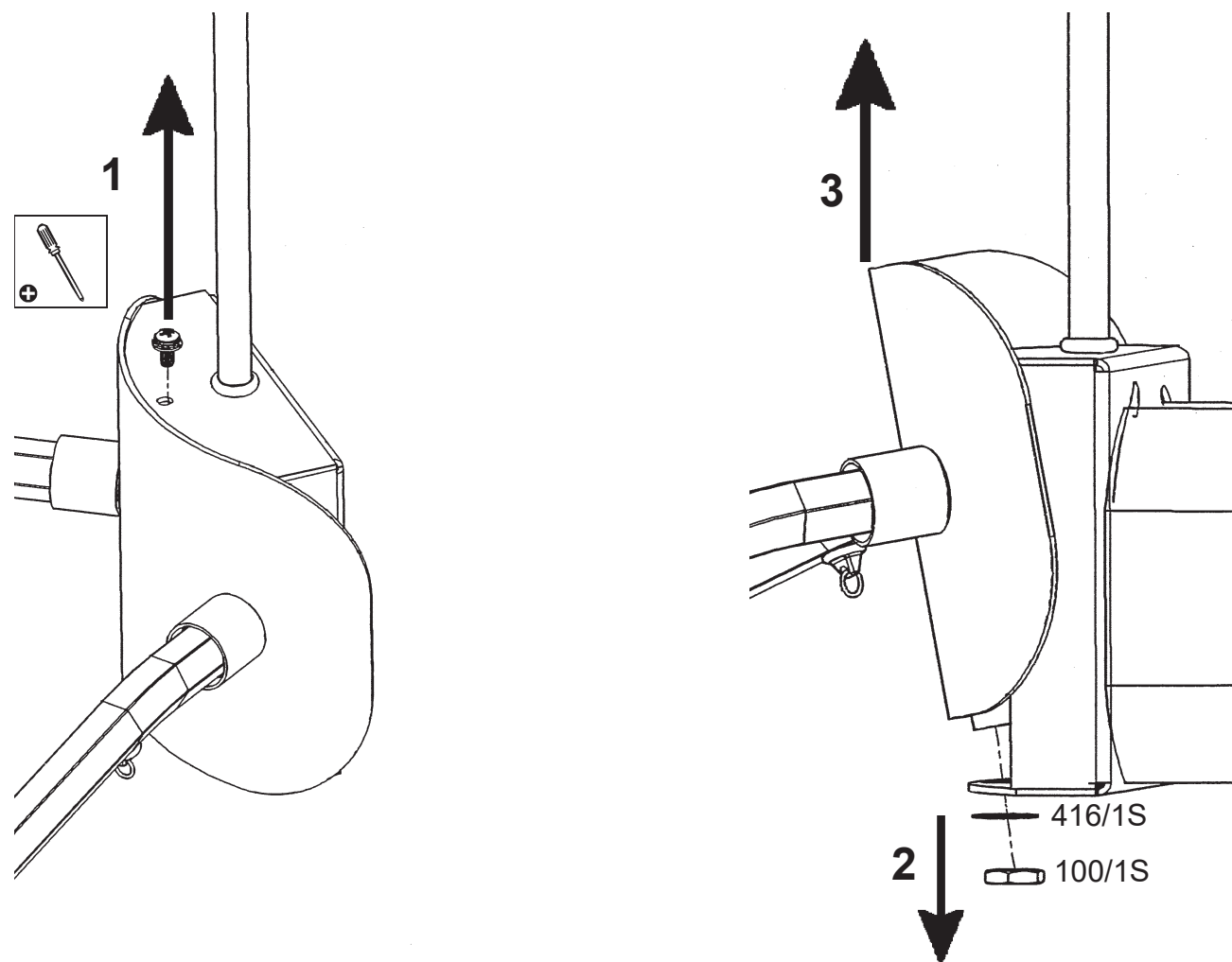

16

TRIM PLATE - TOP VIEW

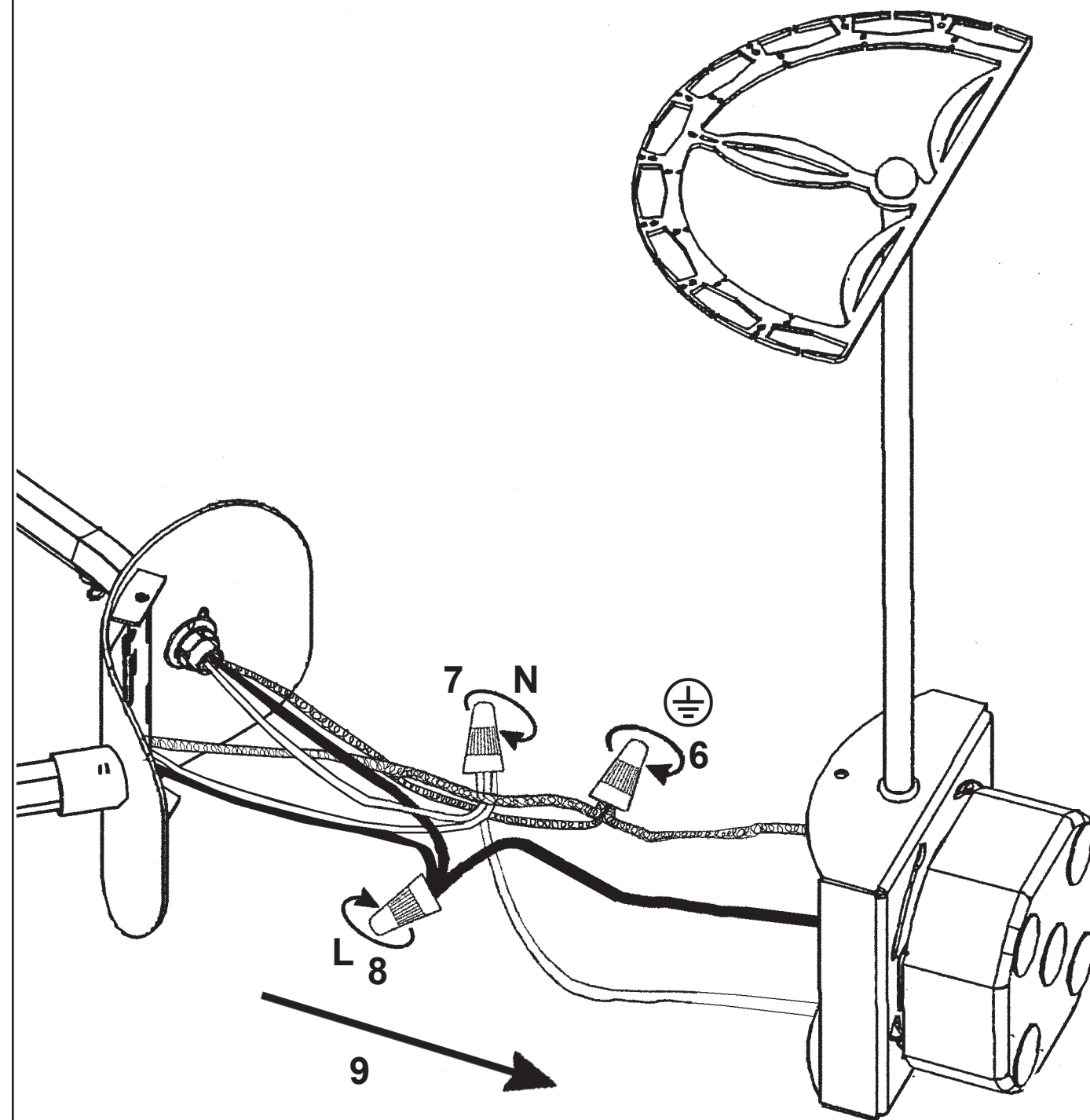
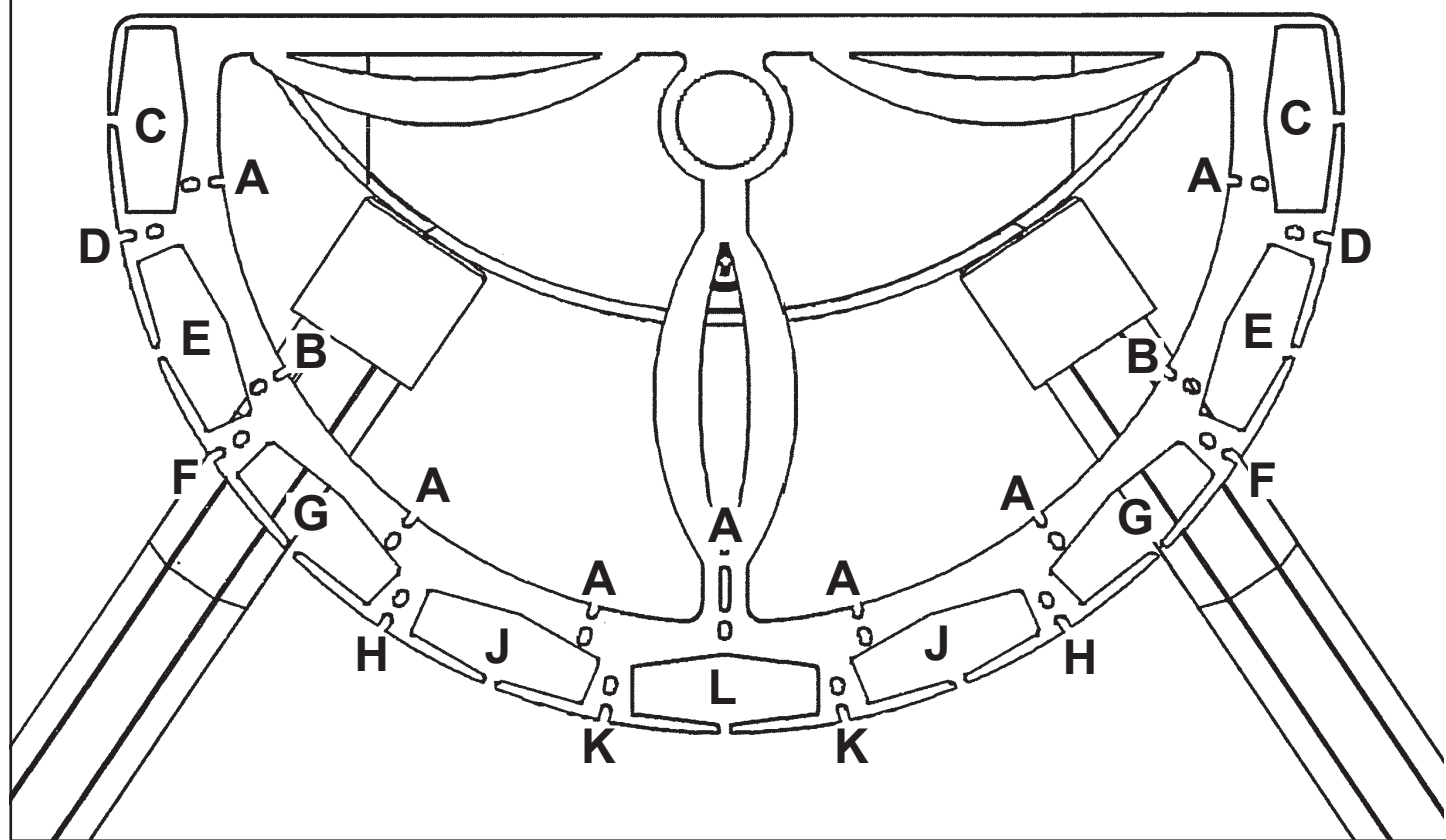

1 X  : 416/1S

1 X  : 100/1S

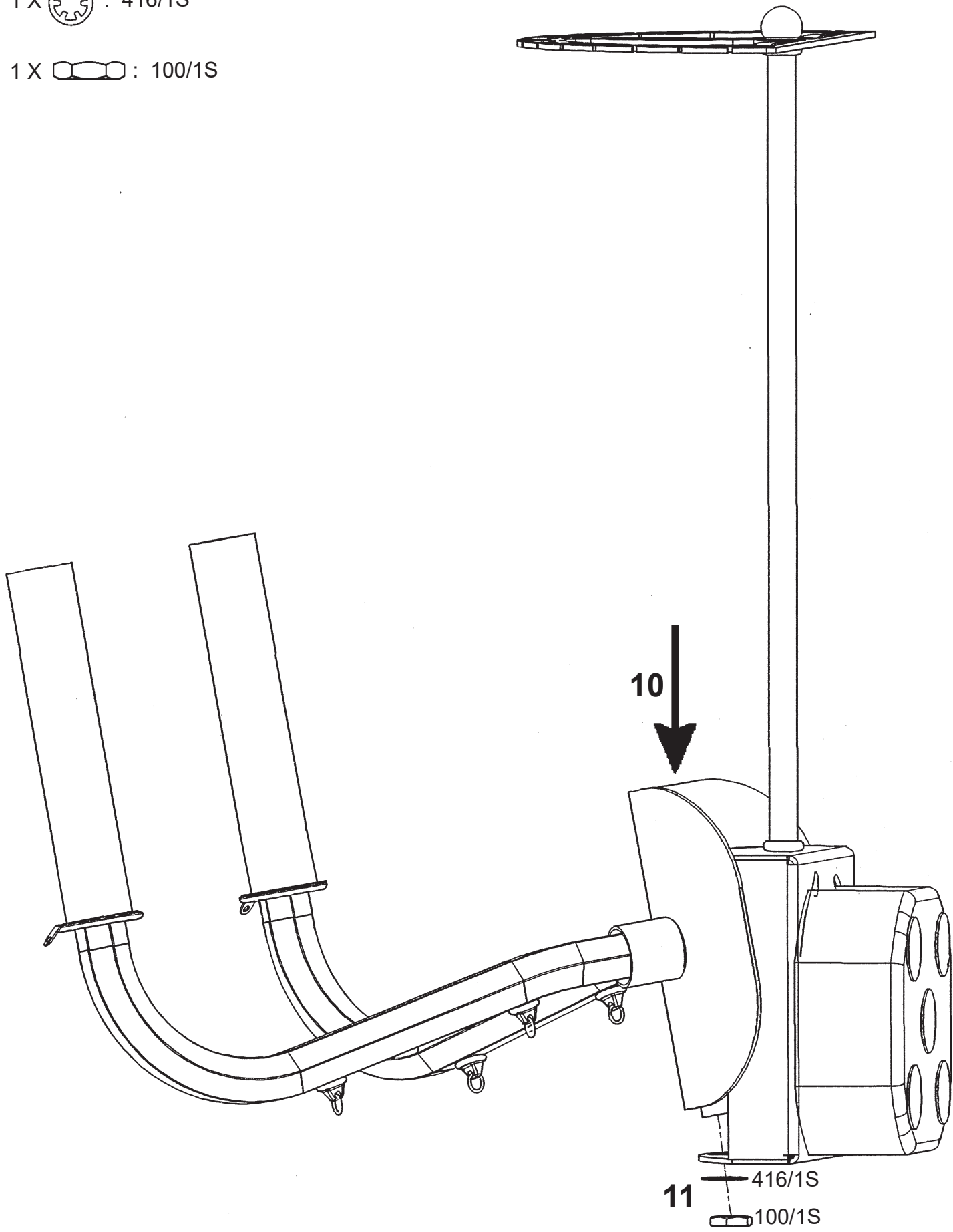

15



You will need 2 - B10
25 Watts Recommended
60 Watts Max

Install bulbs and be sure
to test fixture **BEFORE**
trimming.

