

 **SCHONBEK** | 1870

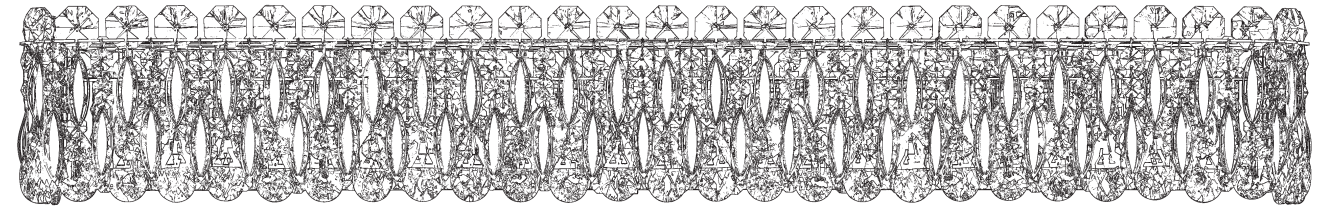









SARELLA
RS8336N- __ __ H



THIS DESIGN IS THE PROPRIETARY
TRADE DRESS/TRADEMARK OF
W SCHONBEK LLC.

8 Lights
Length: 36-1/2"
Height: 5"
Extension: 5-1/2"
Hanging Weight: 16lbs.

 **SCHONBEK** | 1870

								
MAX 40 W	110-120 V							

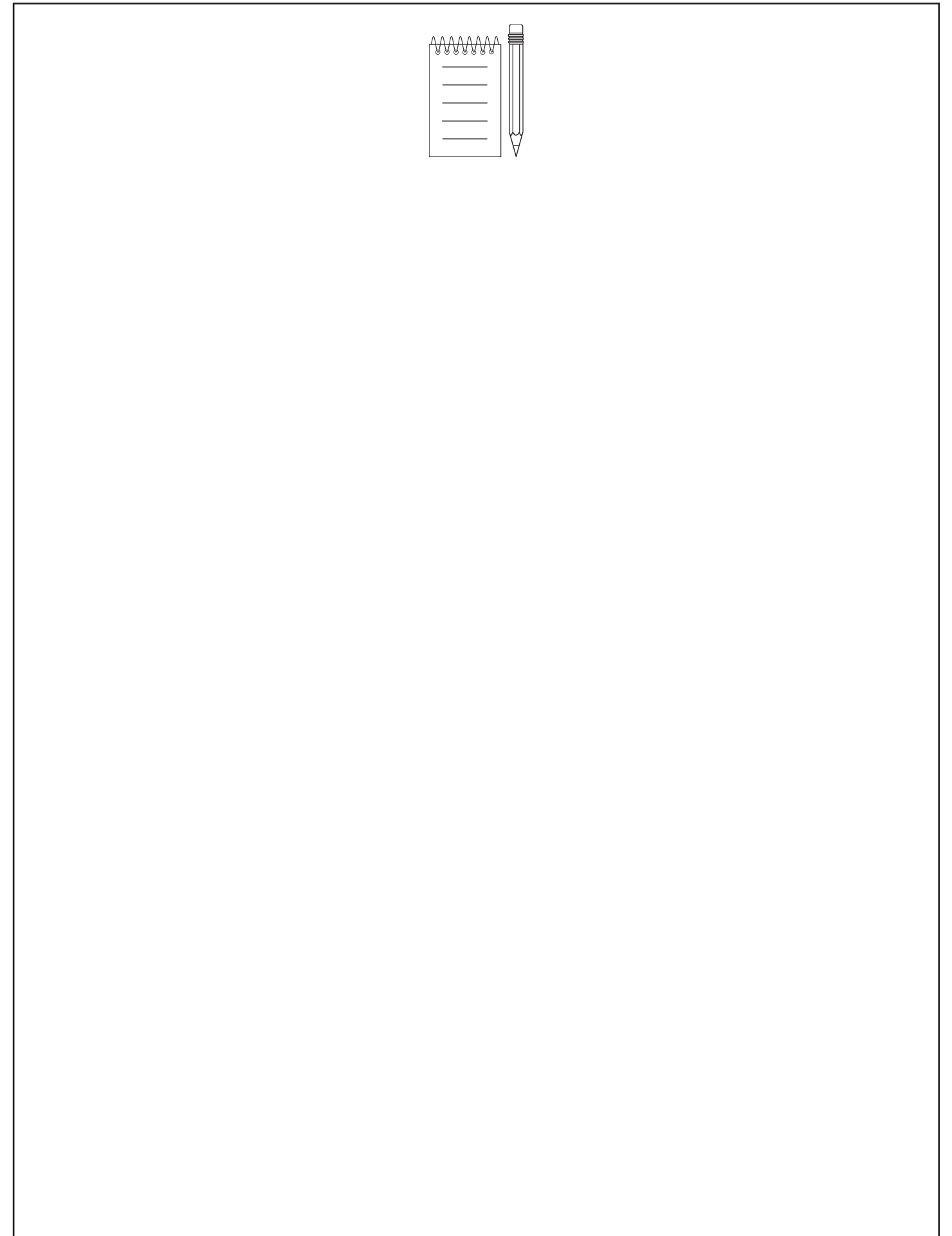
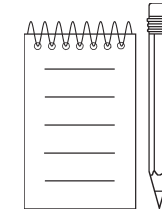
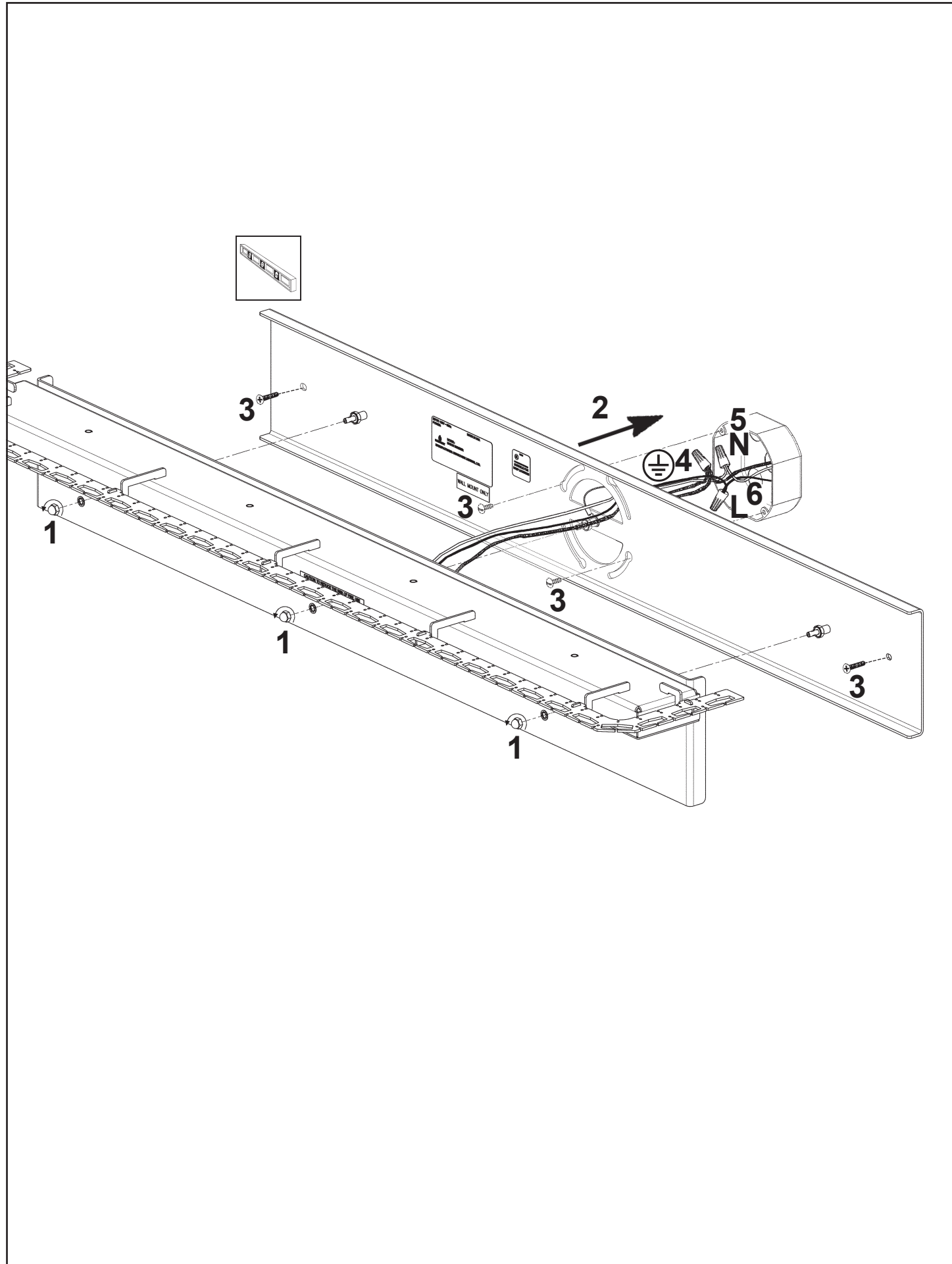

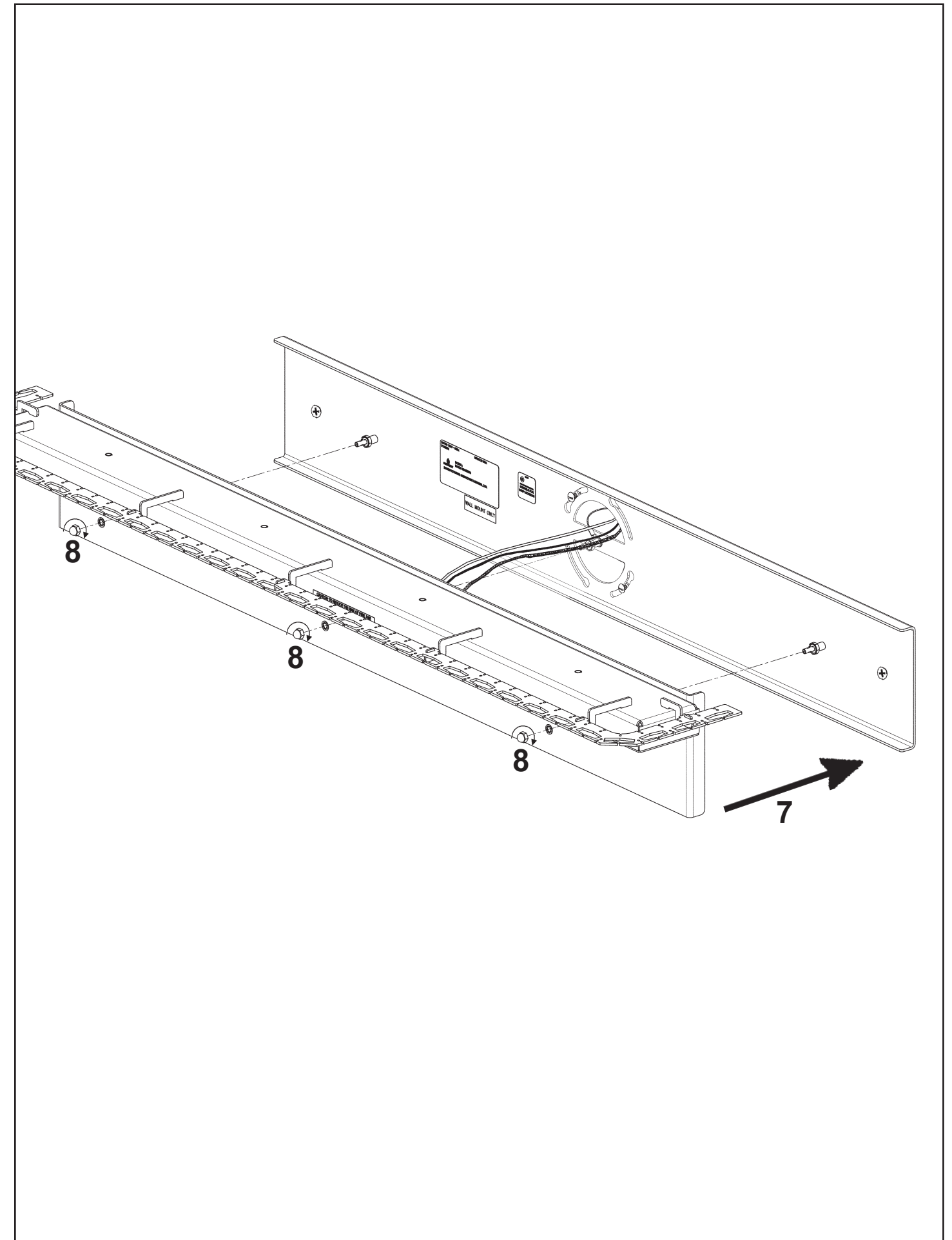
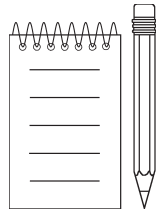

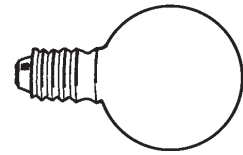

You will need 8 - G16-1/2 Bulbs
40 Watts Max

**Install bulbs and be sure to
test fixture BEFORE trimming.**

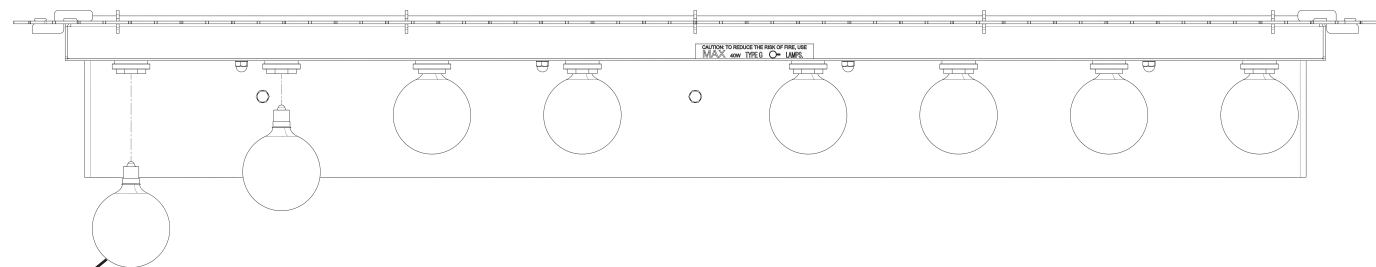

9

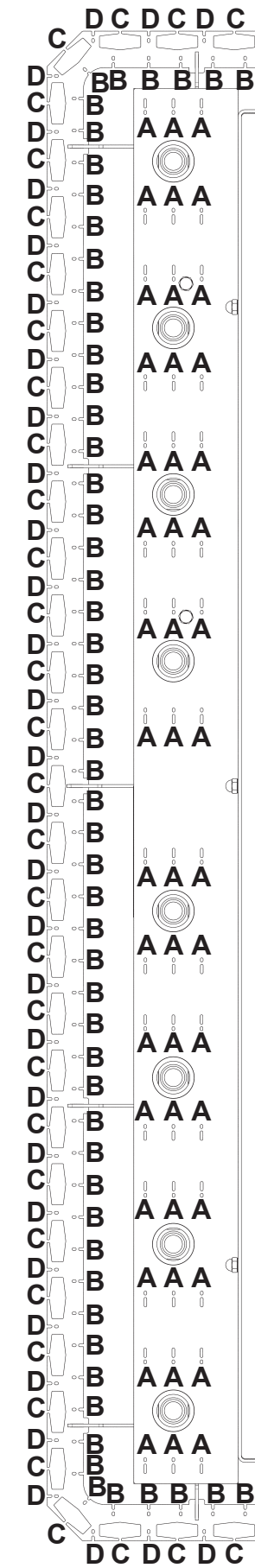

- 10 A
- 11 B
- 12 C
- 13 D

 **SCHONBEK** | 1870



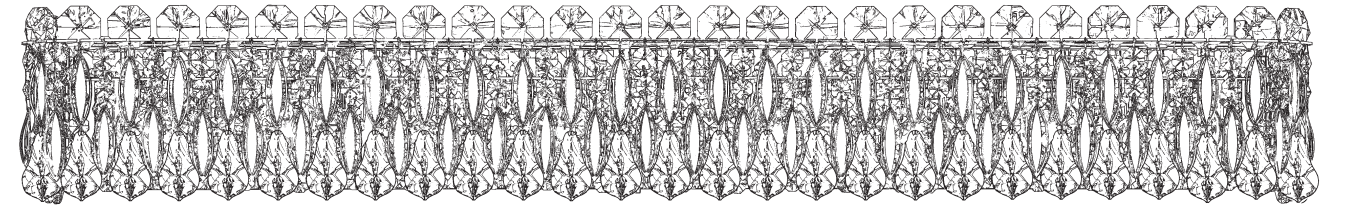







SARELLA
RS8336N- __ __ R



THIS DESIGN IS THE PROPRIETARY
TRADE DRESS/TRADEMARK OF
W SCHONBEK LLC.

8 Lights
Length: 36-1/2"
Height: 5"
Extension: 5-1/2"
Hanging Weight: 16lbs.

 **SCHONBEK** | 1870

								
MAX 40 W	110-120 V							

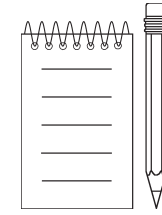
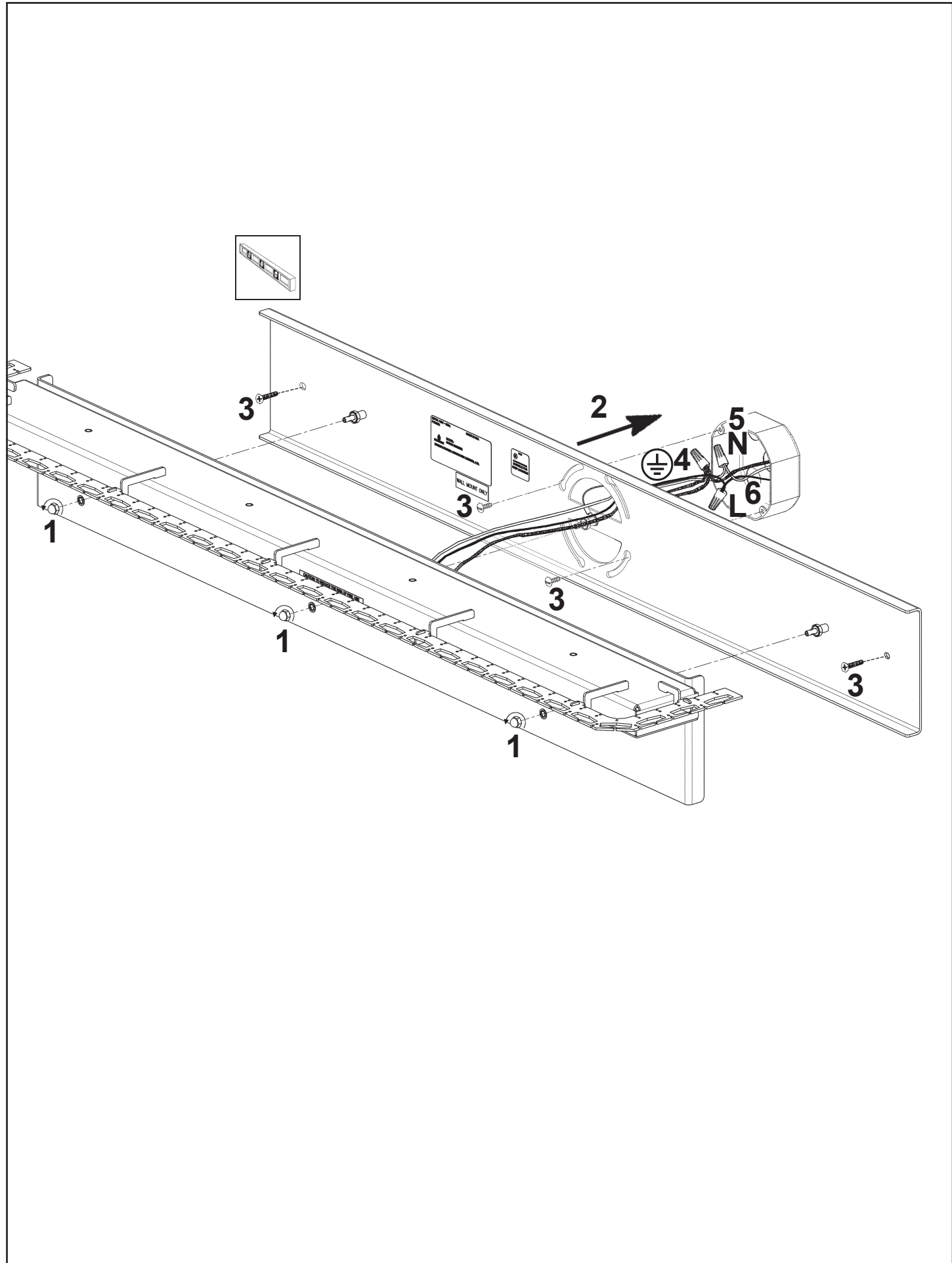

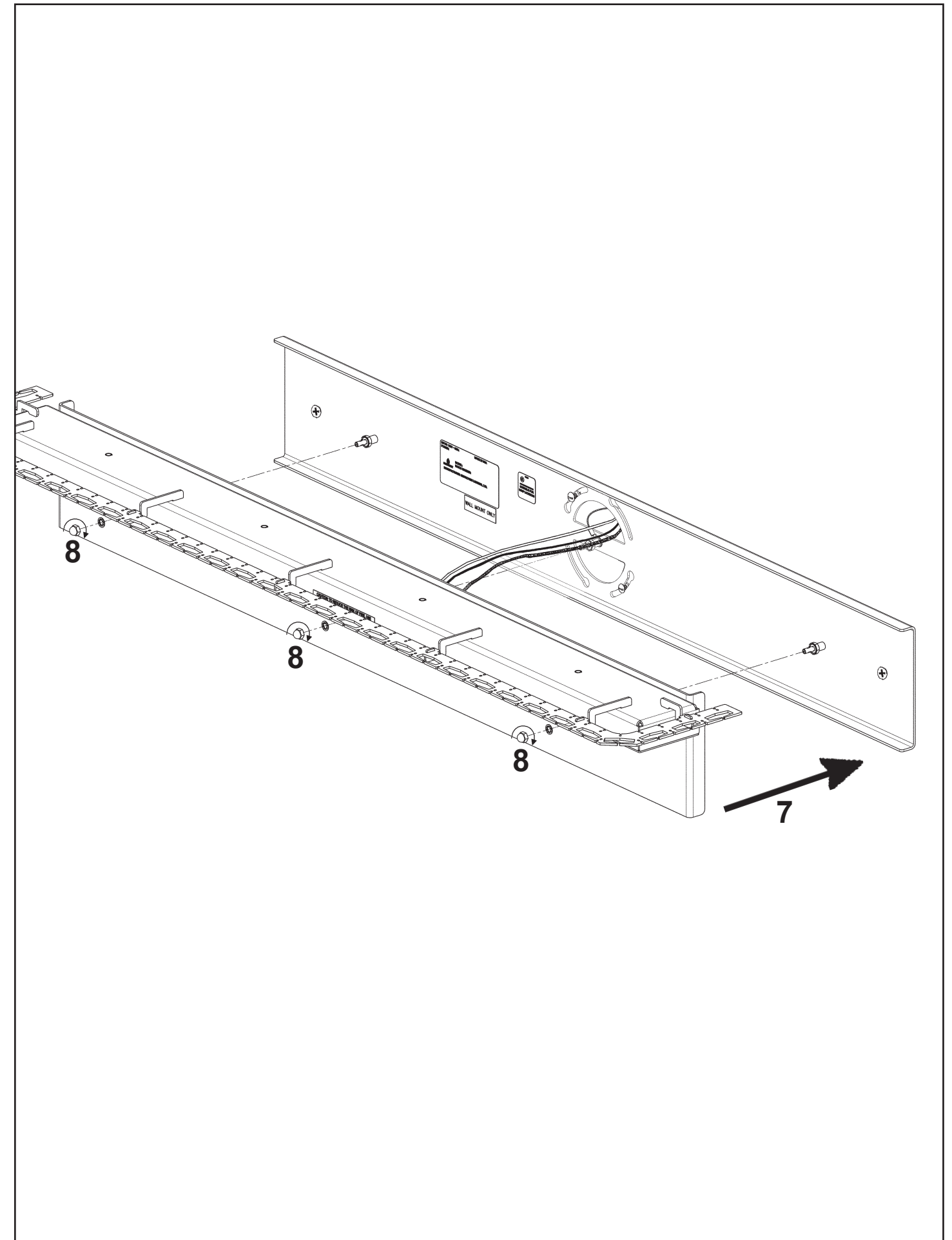
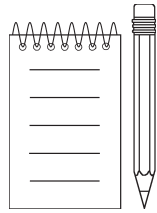

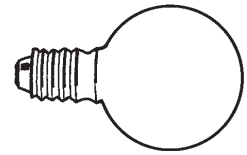

You will need 8 - G16-1/2 Bulbs
40 Watts Max

**Install bulbs and be sure to
test fixture BEFORE trimming.**

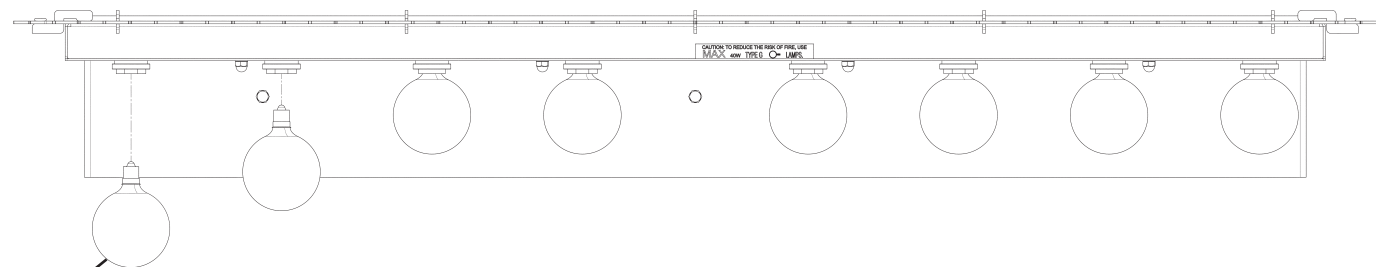

9

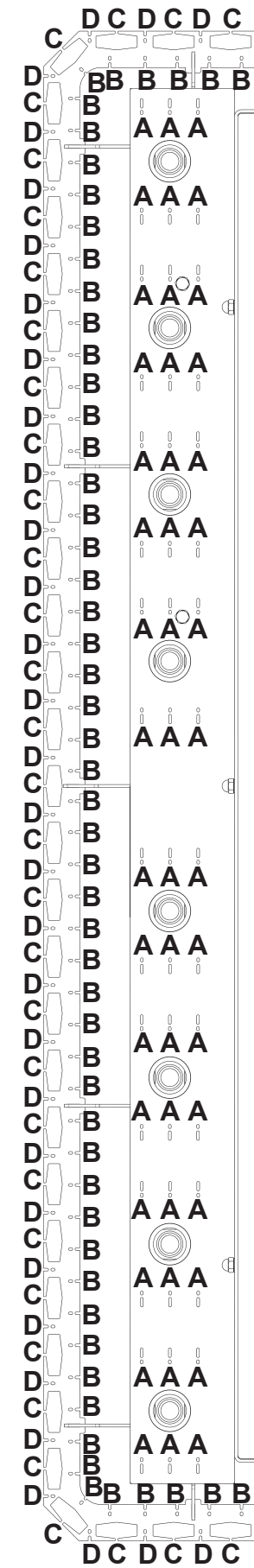

10

A

11

B

12

C

13

D

 **SCHONBEK** | 1870



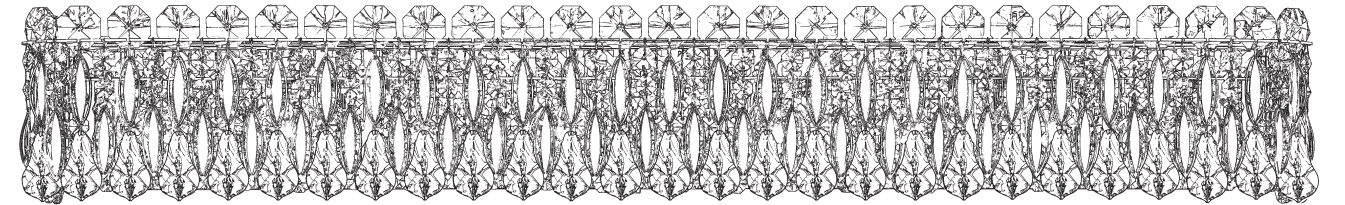





SARELLA
RS8336N- __ __ S



THIS DESIGN IS THE PROPRIETARY
TRADE DRESS/TRADEMARK OF
W SCHONBEK LLC.

8 Lights
Length: 36-1/2"
Height: 5"
Extension: 5-1/2"
Hanging Weight: 16lbs.

 **SCHONBEK** | 1870

								
MAX 40 W	110-120 V	