

SARELLA RS8347N- __ __ H

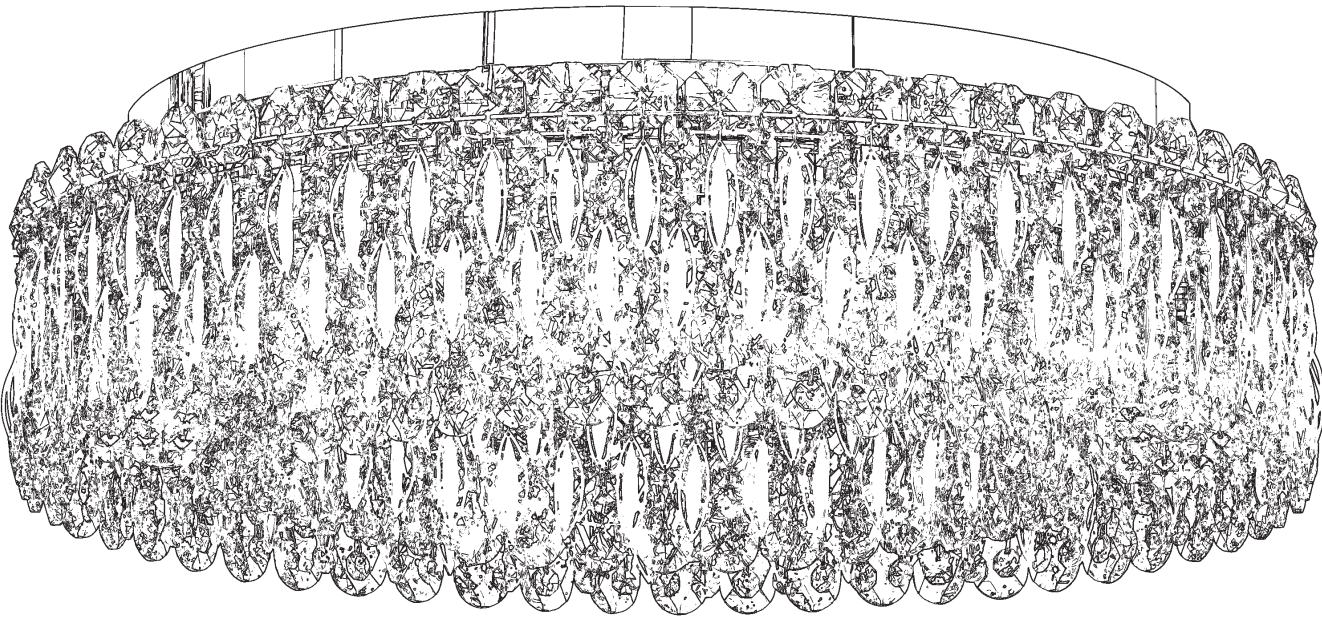











12 Lights
Diameter: 24"
Height: 7-1/2"
Hanging Weight: 37lbs.

THIS DESIGN IS THE PROPRIETARY
TRADE DRESS/TRADEMARK OF
W SCHONBEK LLC.

 **SCHONBEK** | 1870

 **SCHONBEK** | 1870

								
MAX 40 W		110-120 V						

1 X  : 1746

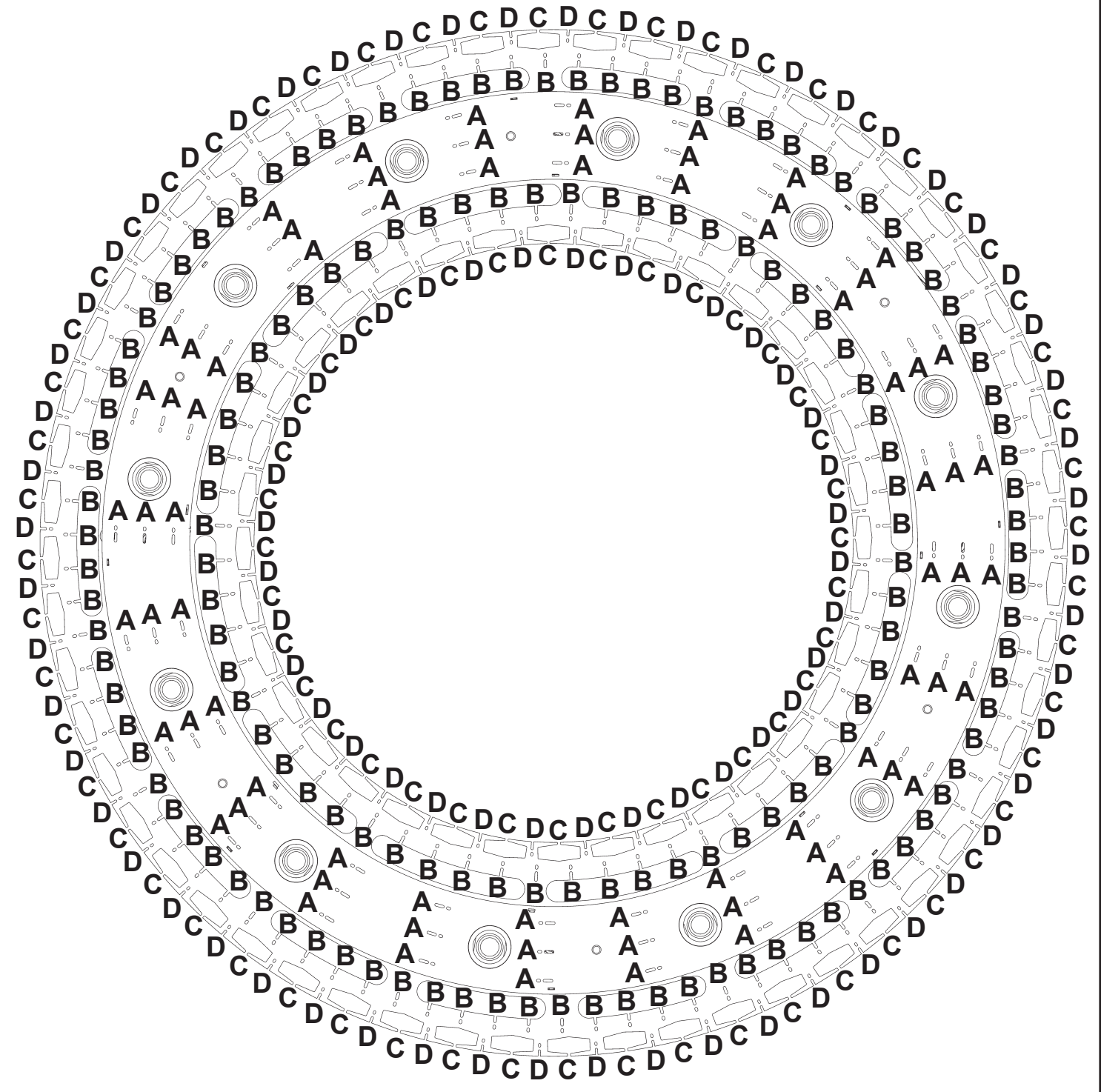
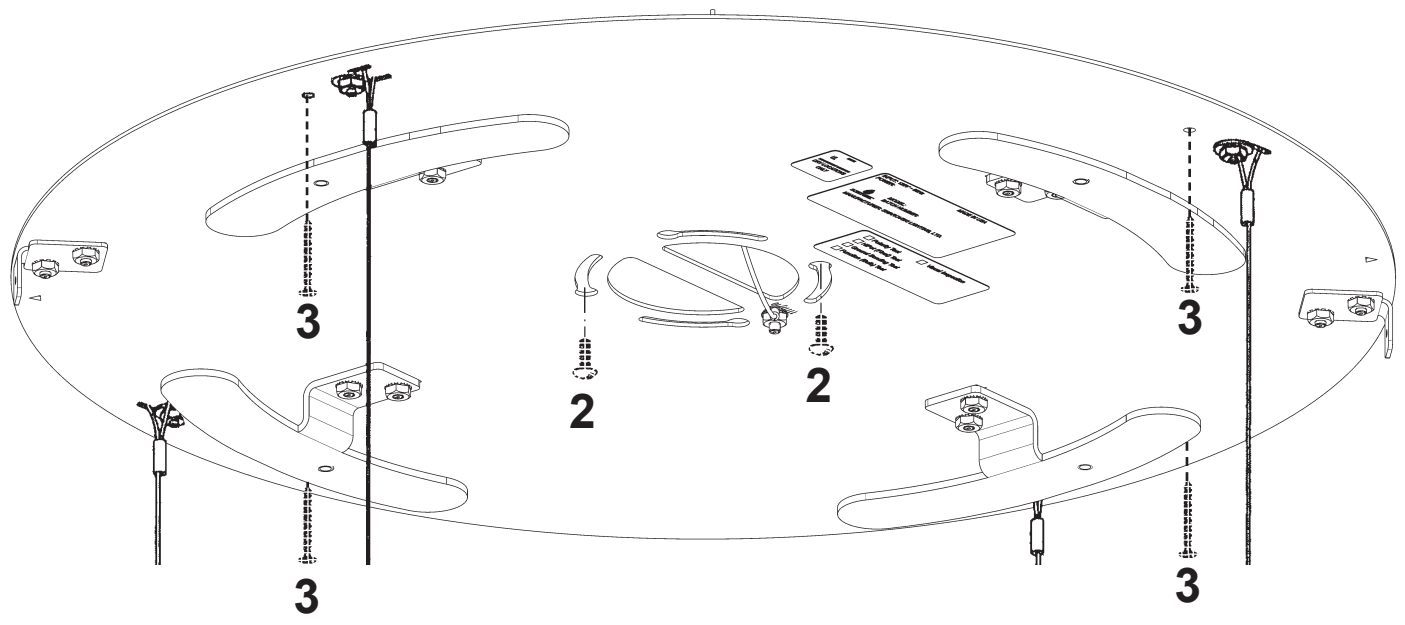
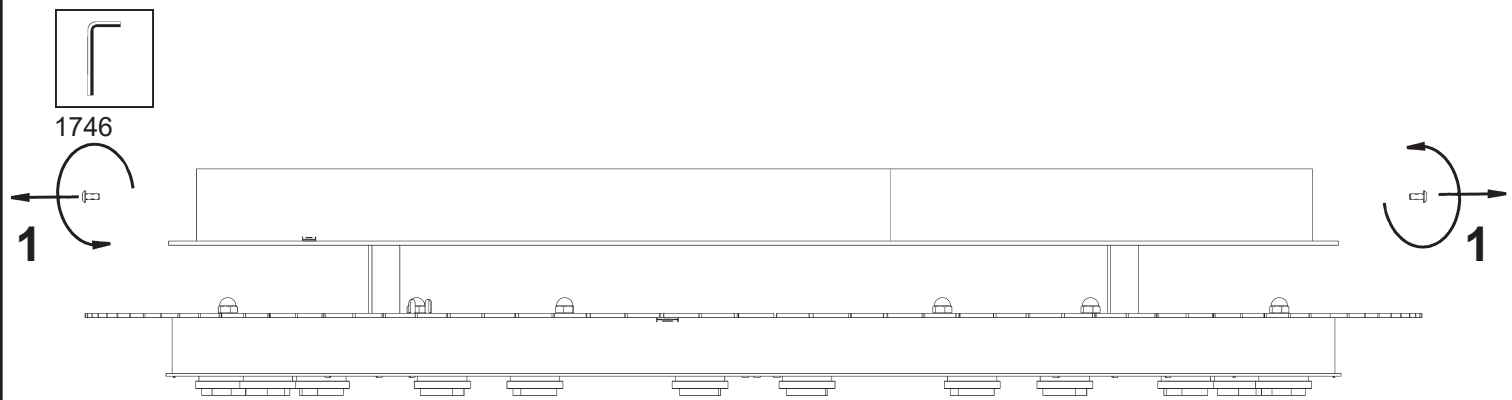

11	A
12	B
13	C
14	D

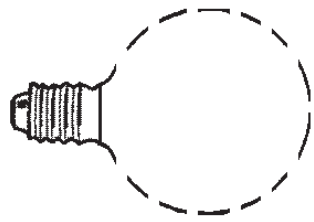

You will need 12 - G16-1/2
40 Watts Max

**Install bulbs and be sure
to test fixture BEFORE
trimming.**

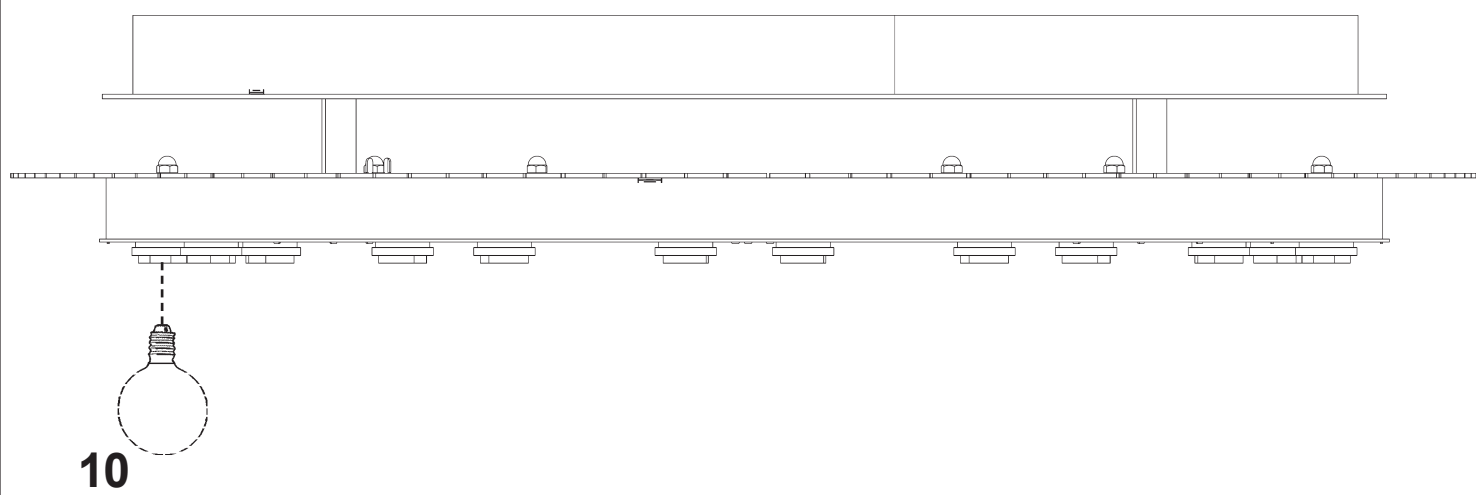

10

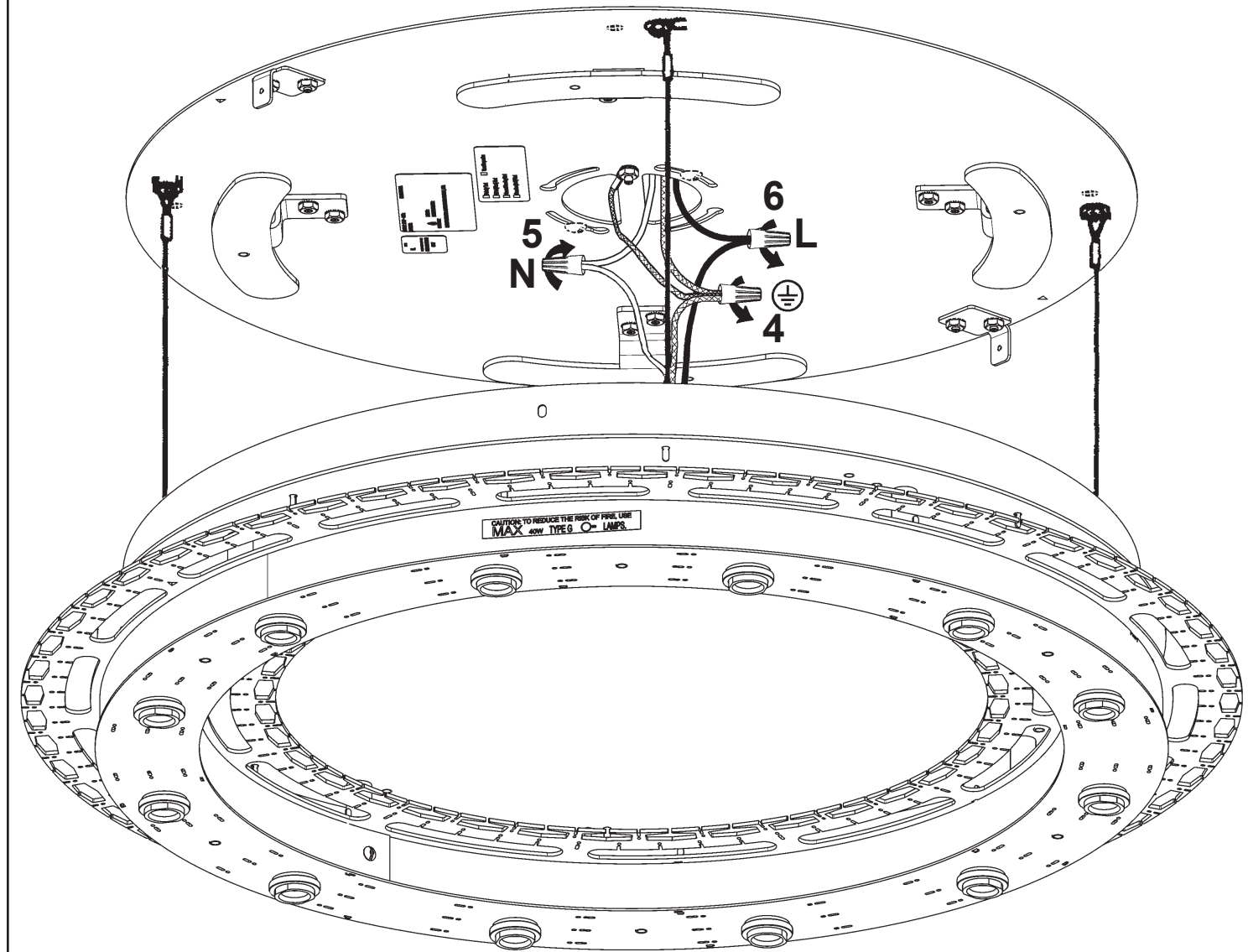

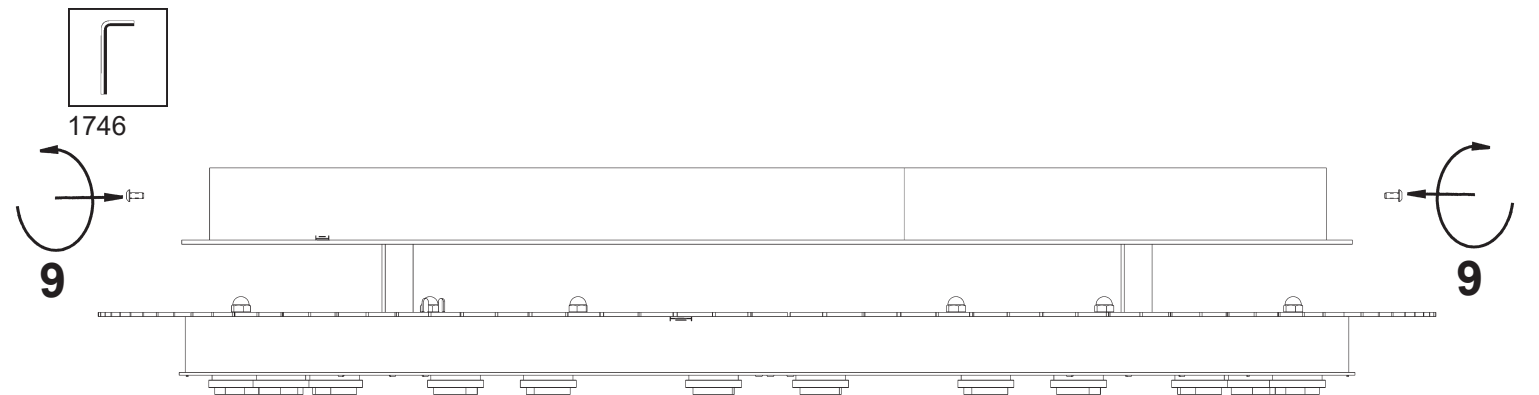
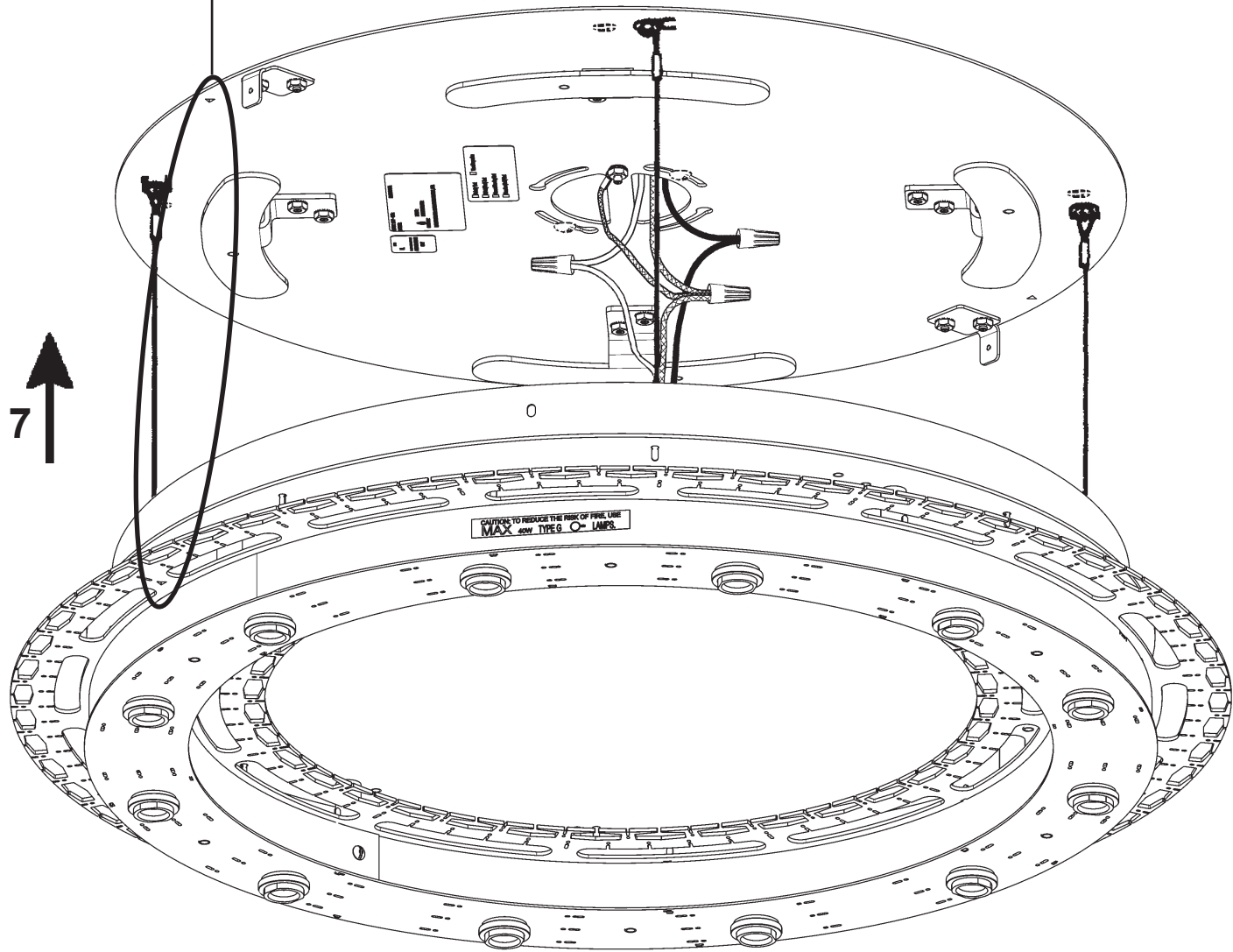
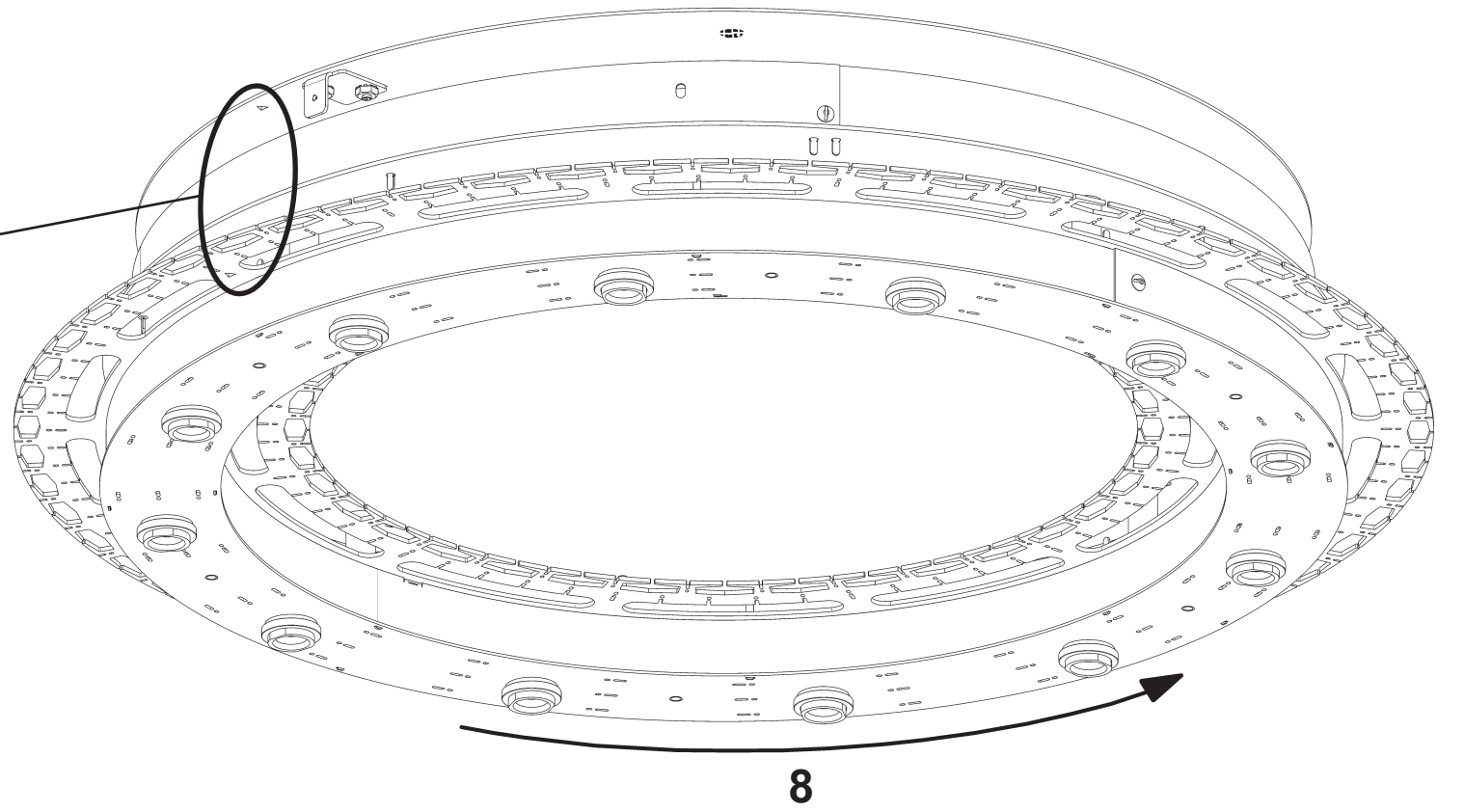
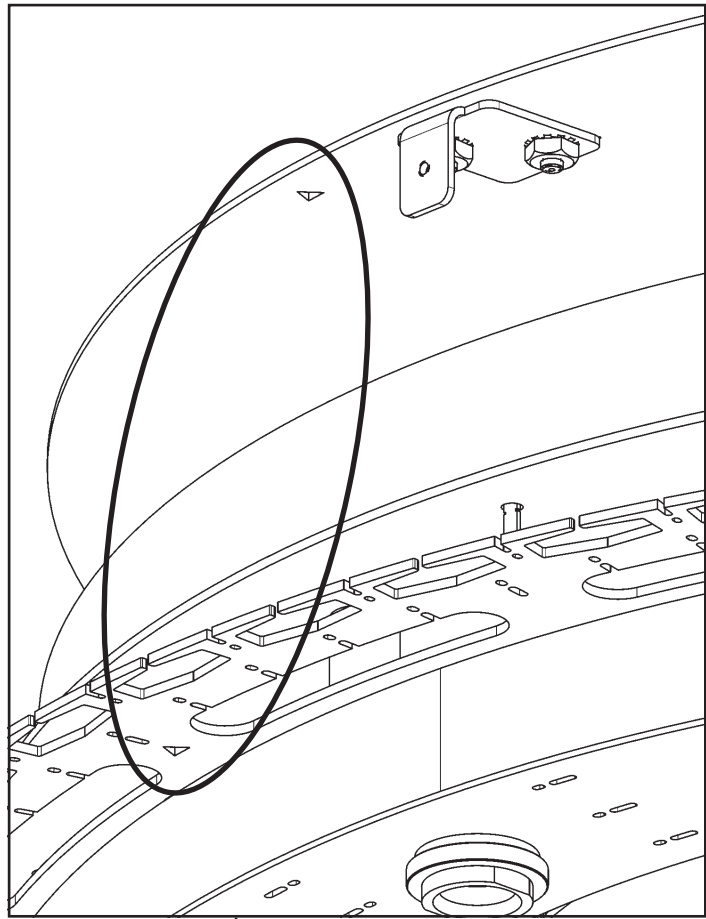

SARELLA RS8347N- __ __ R

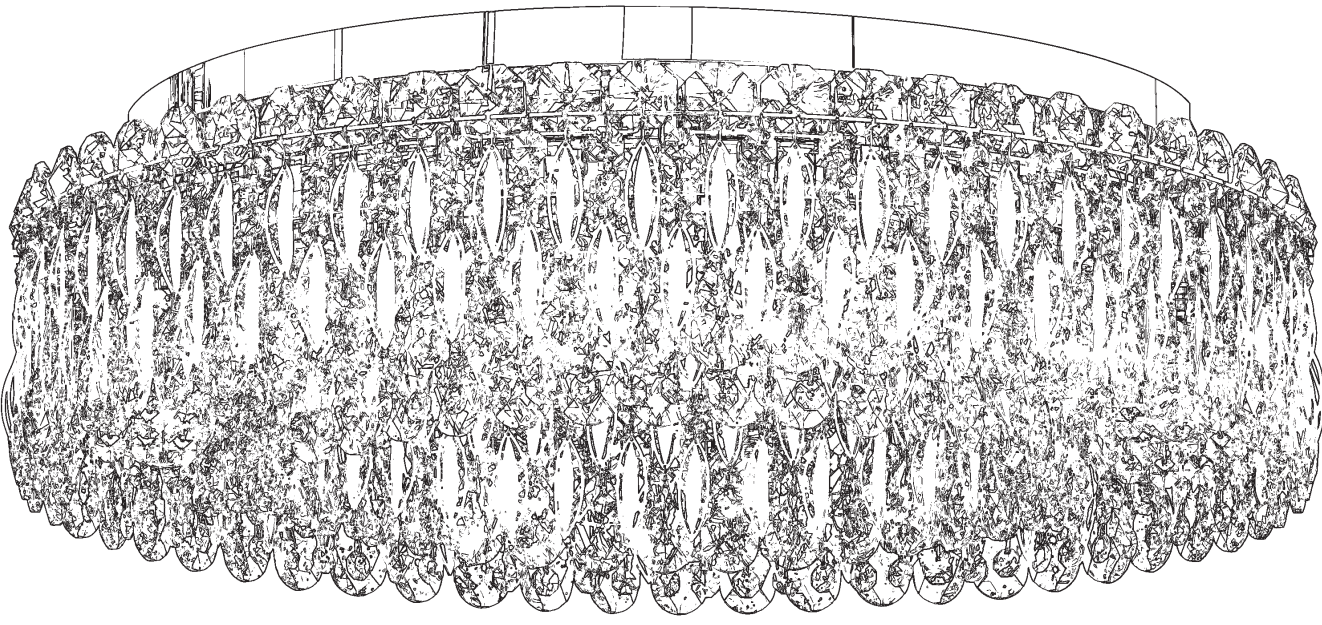











12 Lights
Diameter: 24"
Height: 7-1/2"
Hanging Weight: 37lbs.

THIS DESIGN IS THE PROPRIETARY
TRADE DRESS/TRADEMARK OF
W SCHONBEK LLC.

 **SCHONBEK** | 1870

 **SCHONBEK** | 1870

								
MAX 40 W		110-120 V						

1 X  : 1746

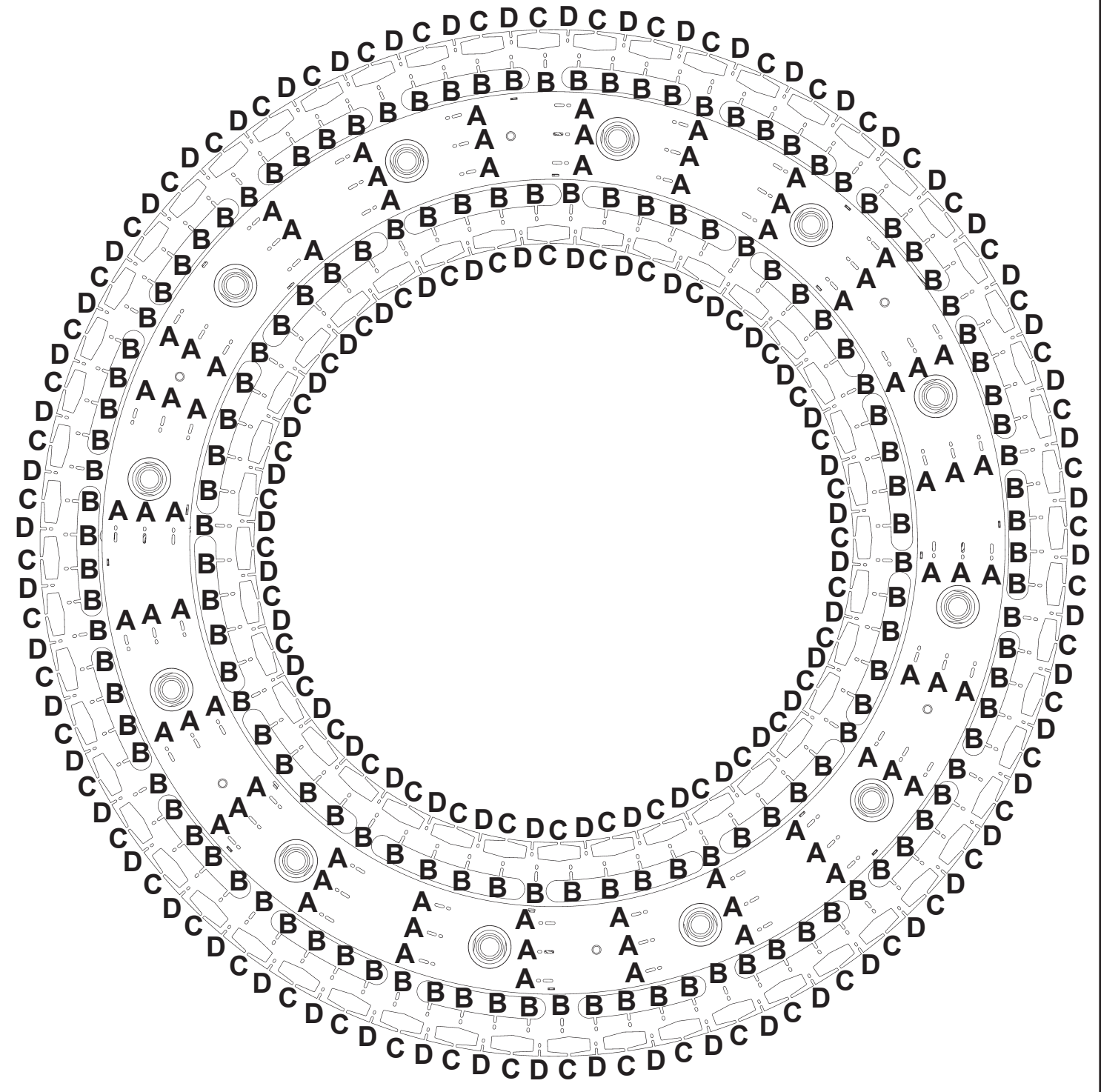
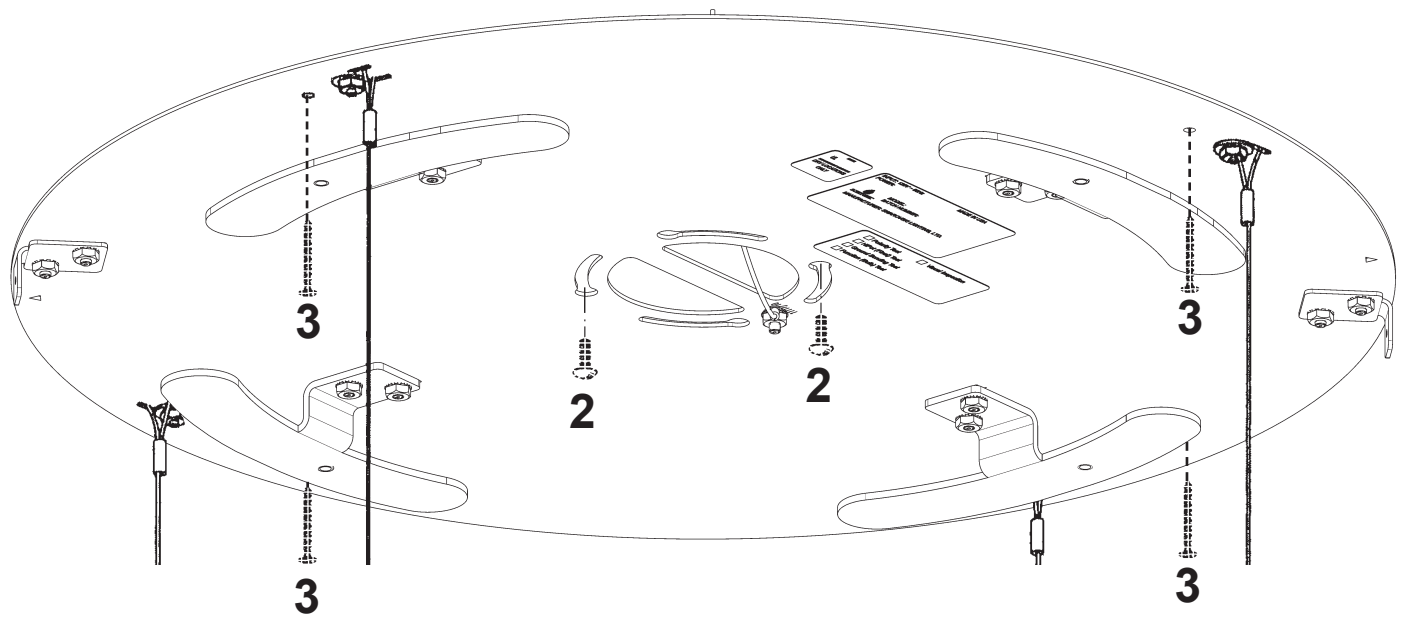
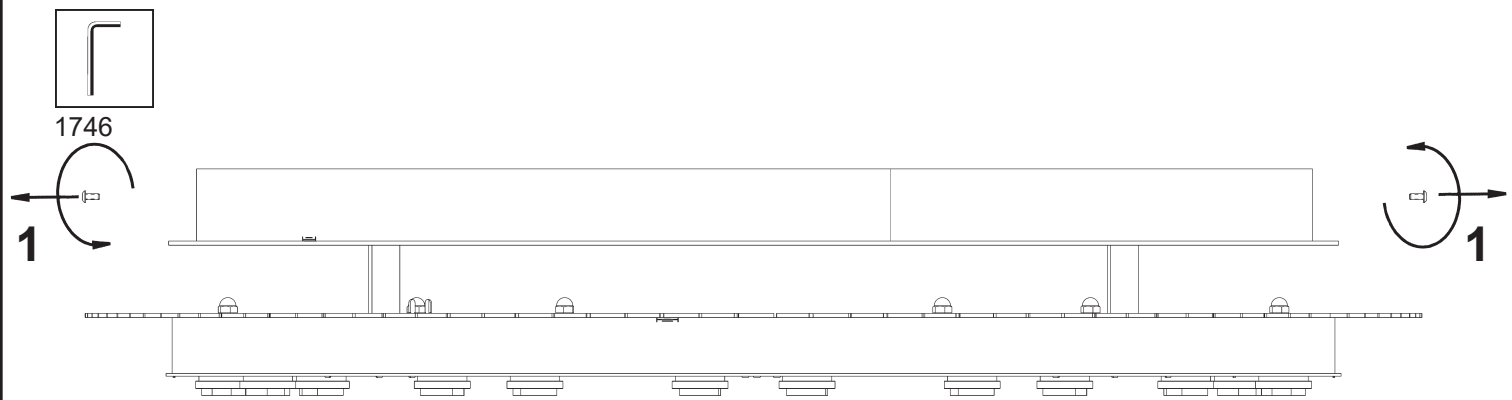

11	A
12	B
13	C
14	D

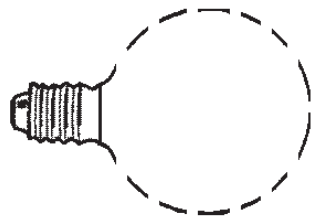

You will need 12 - G16-1/2
40 Watts Max

**Install bulbs and be sure
to test fixture BEFORE
trimming.**

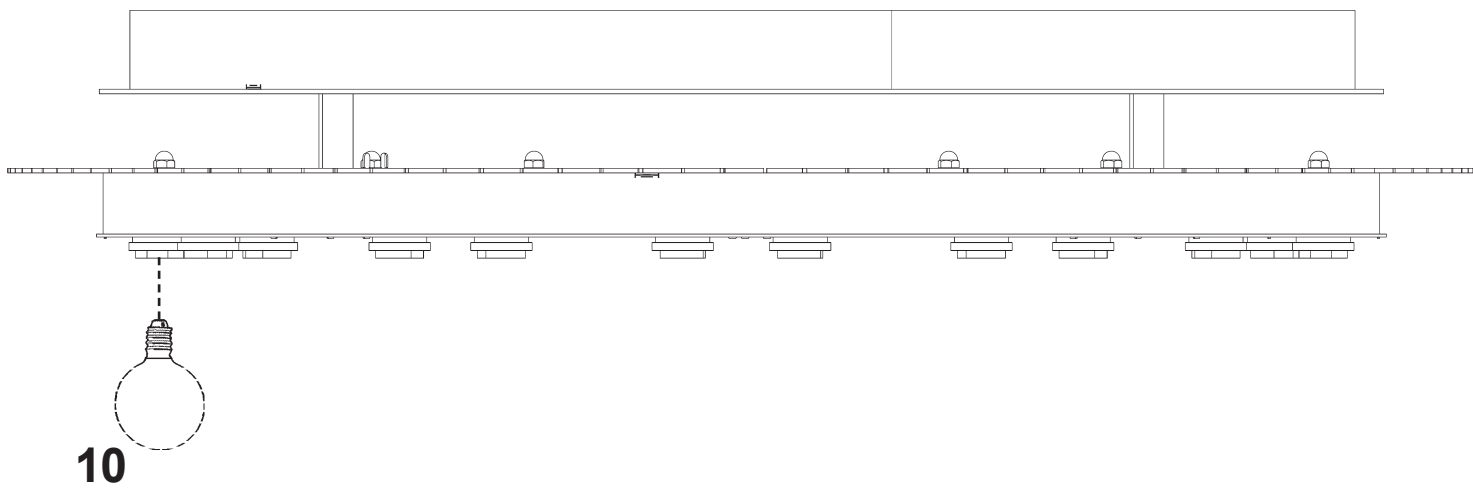

10

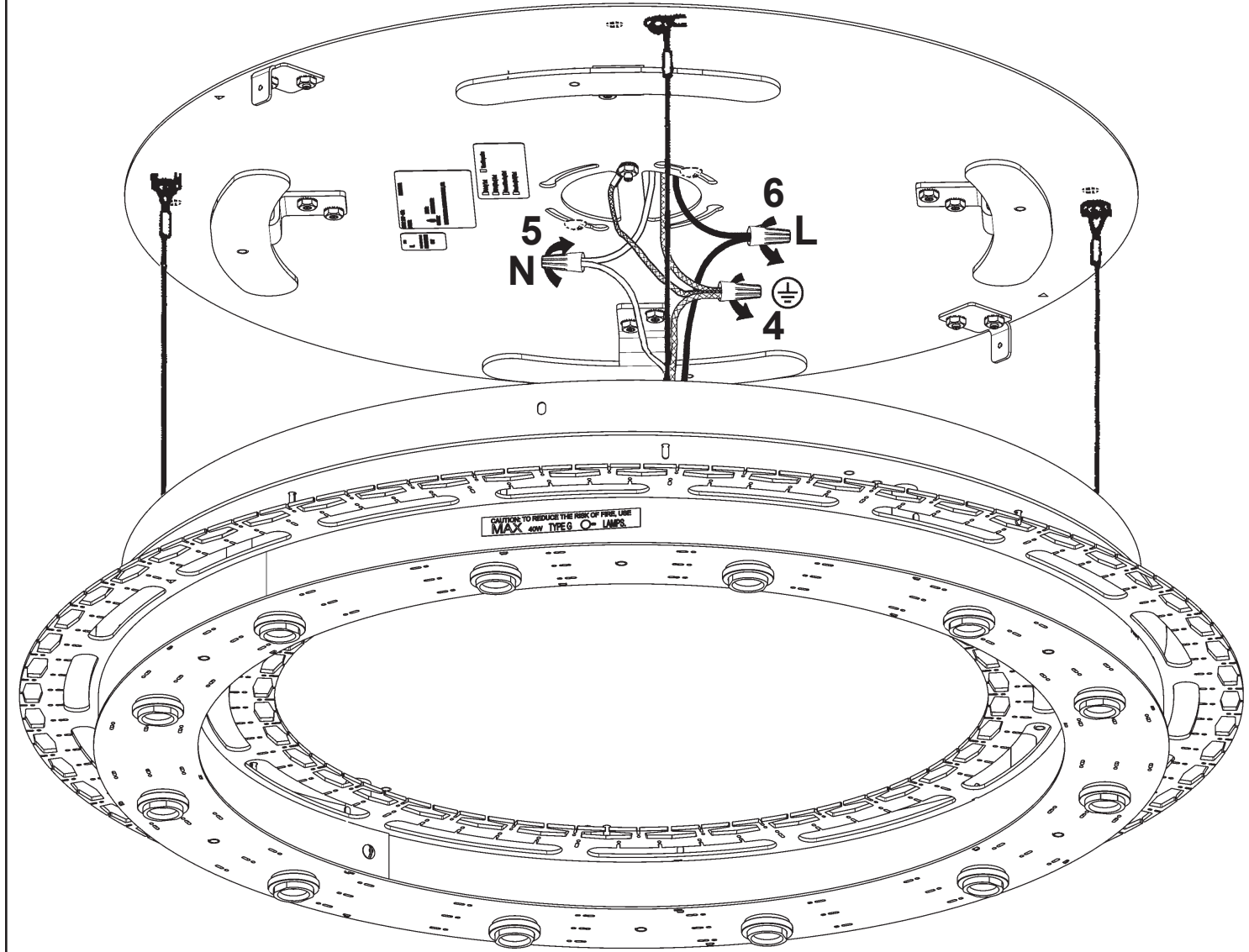

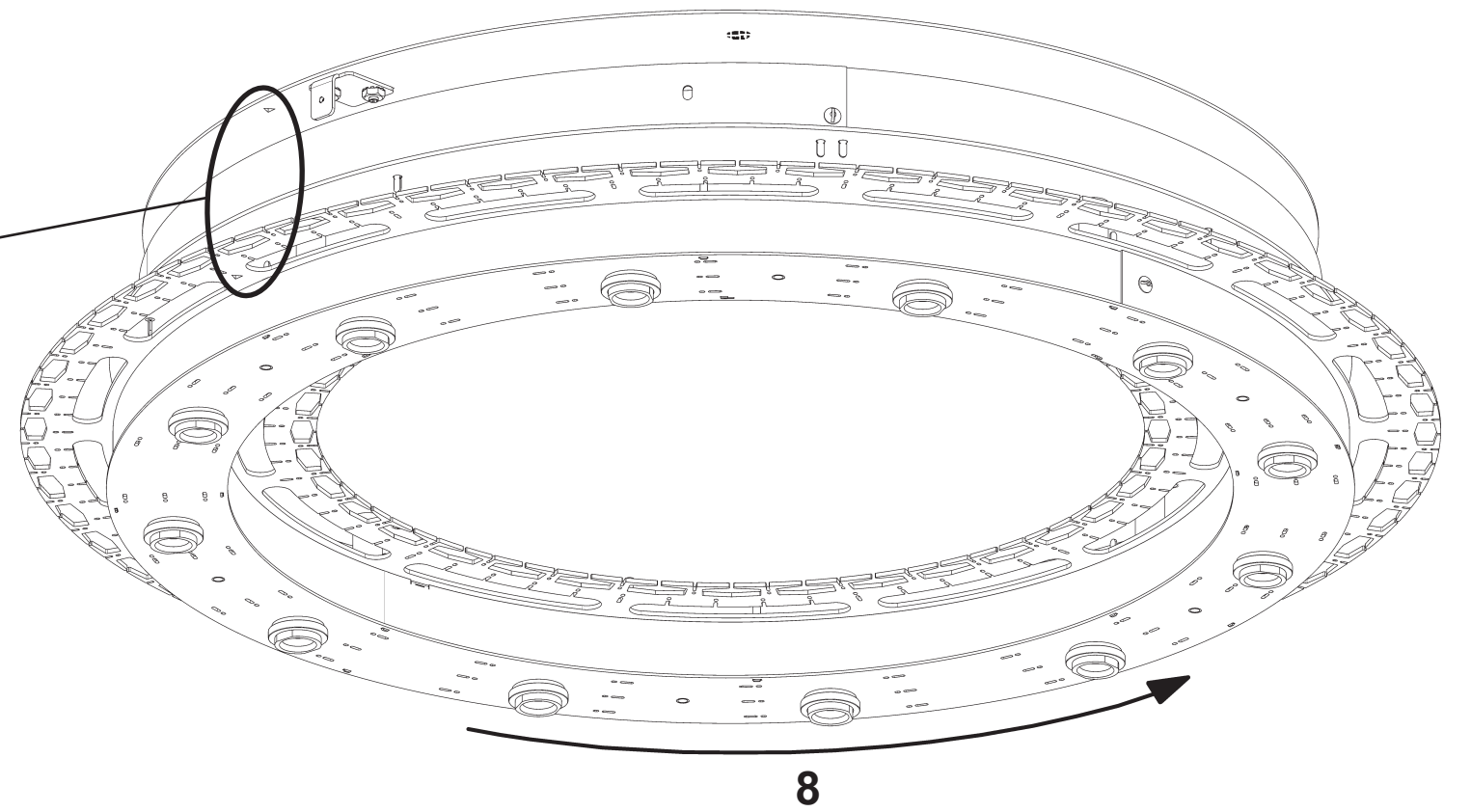
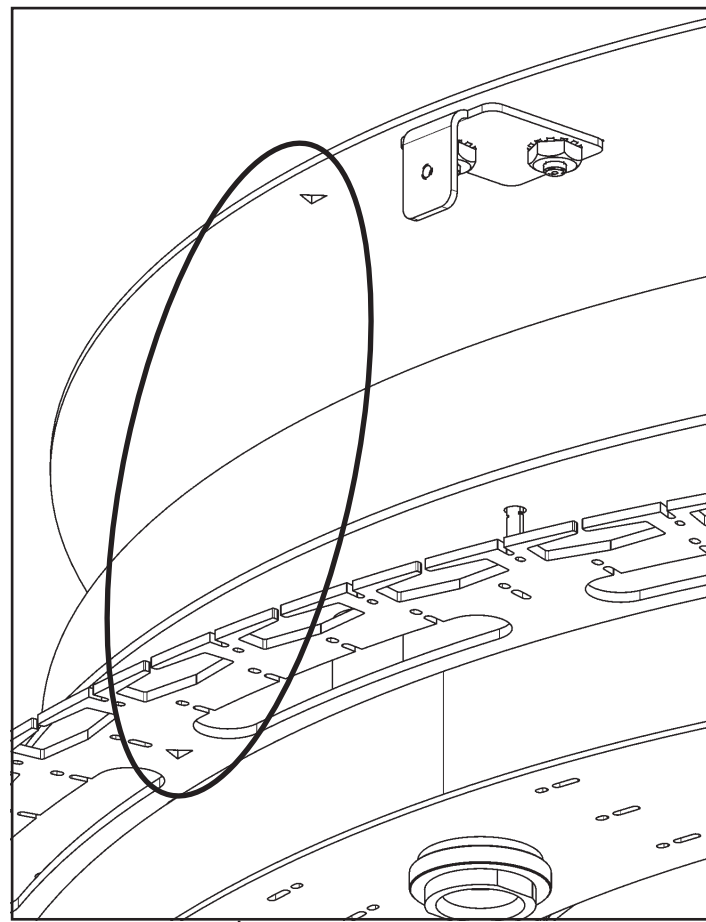

8

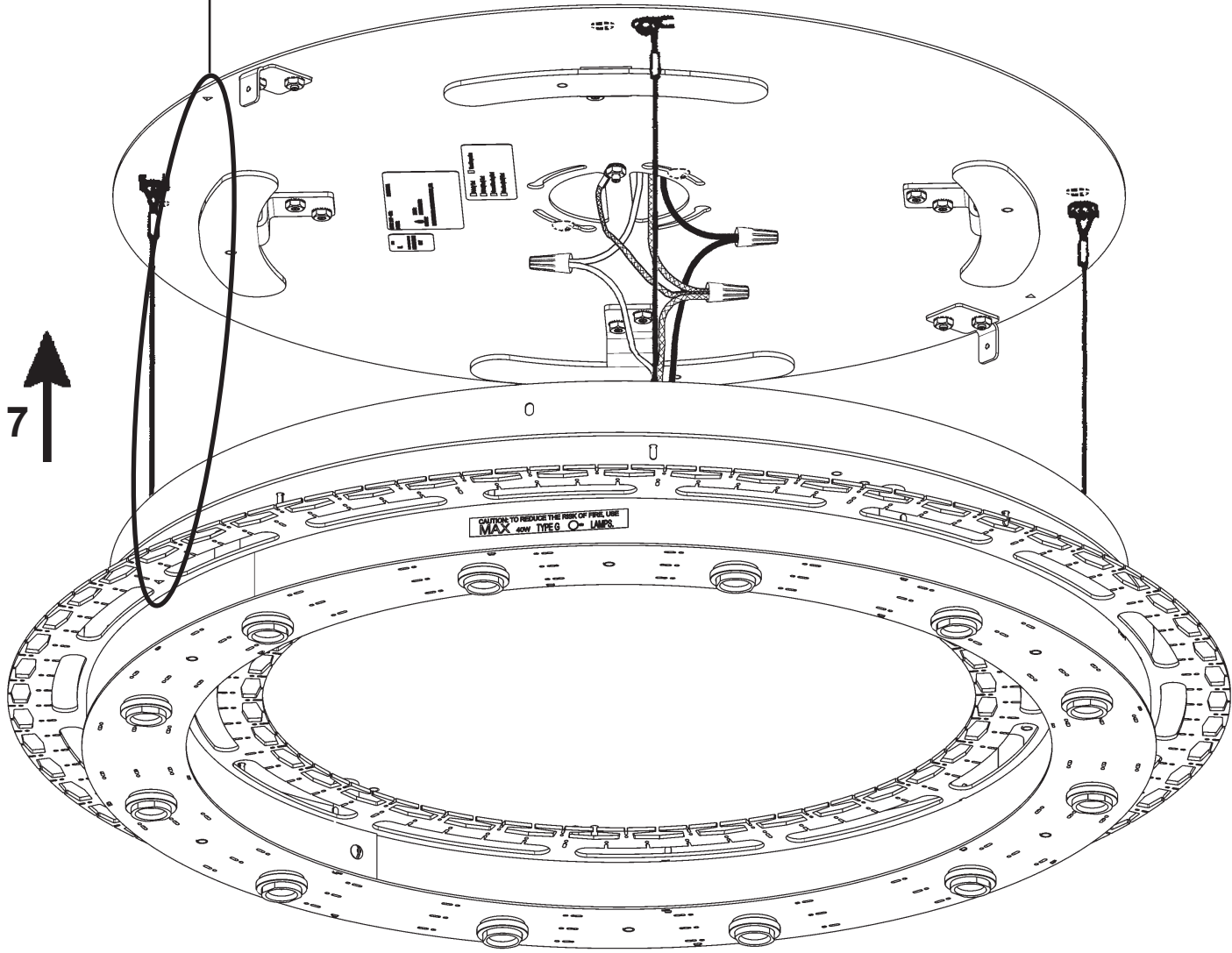

7

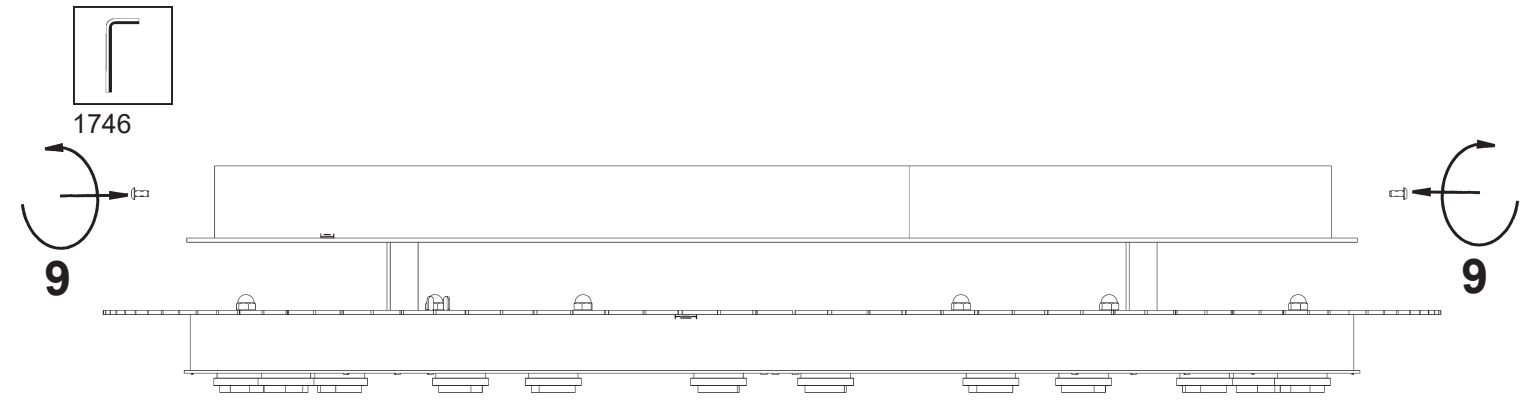

1746

9

9

CAUTION TO PREVENT THE RISK OF FIRE USE
MAX. 40W TYPE G-9 LAMPS.



SARELLA RS8347N-__ __S

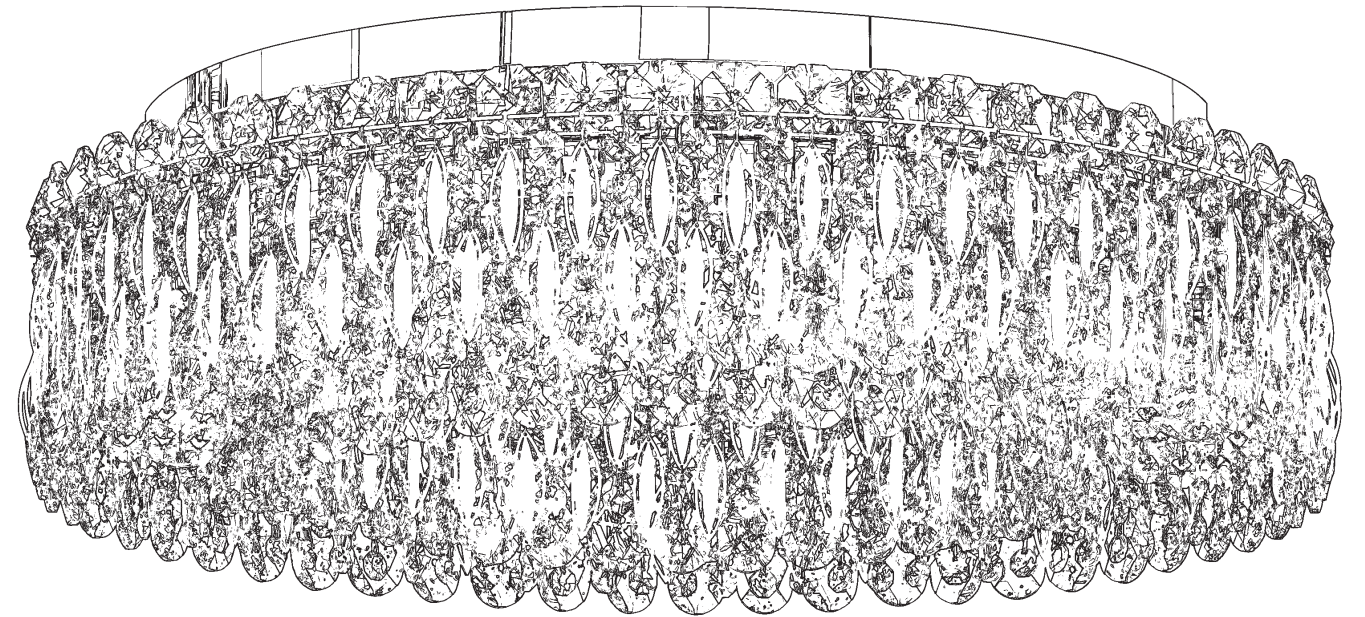











12 Lights
Diameter: 24"
Height: 7-1/2"
Hanging Weight: 37lbs.

THIS DESIGN IS THE PROPRIETARY
TRADE DRESS/TRADEMARK OF
W SCHONBEK LLC.

 **SCHONBEK** | 1870

 **SCHONBEK** | 1870

								
MAX <u>40</u> W		110-120 V						

1 X  : 1746

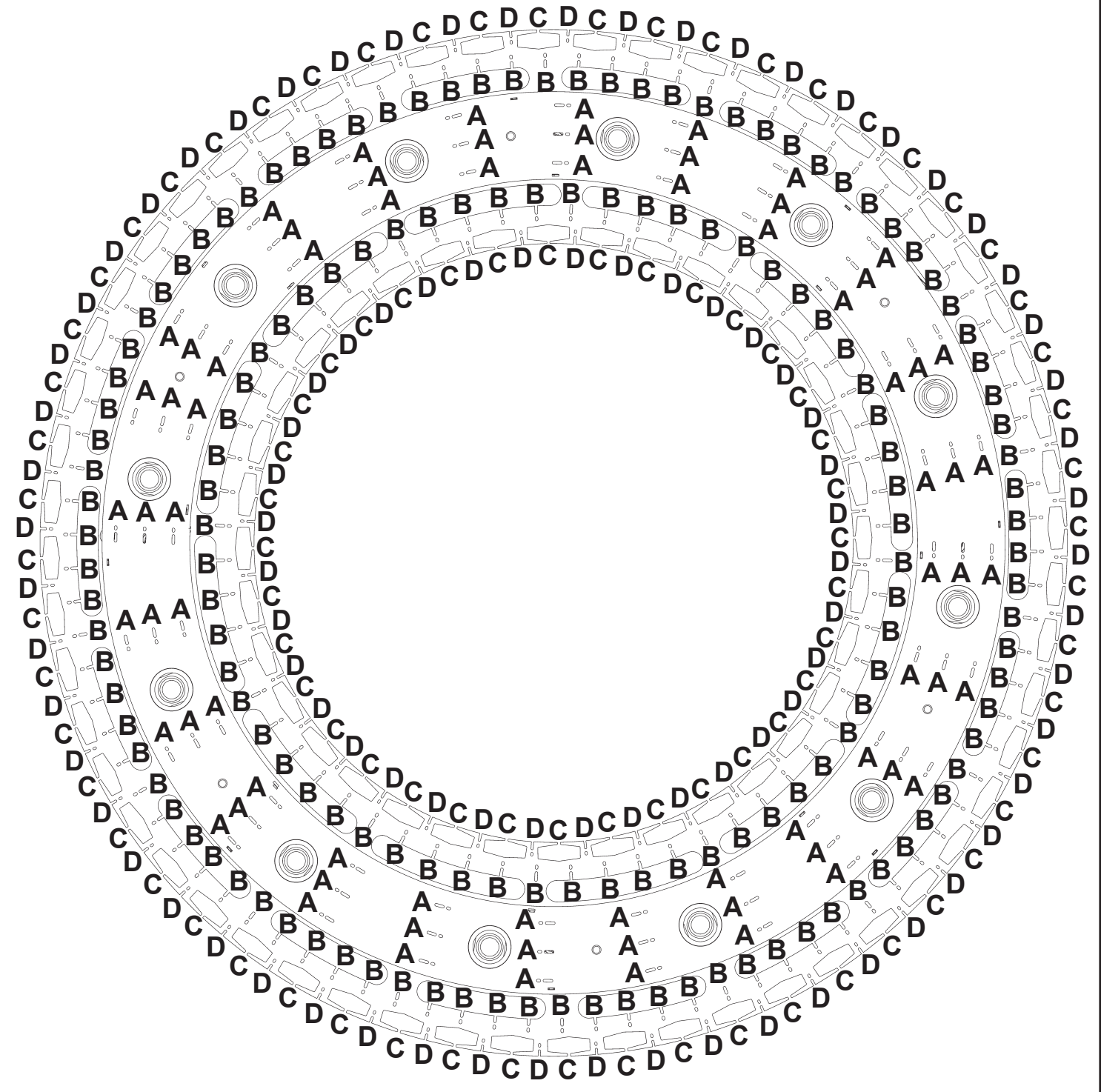
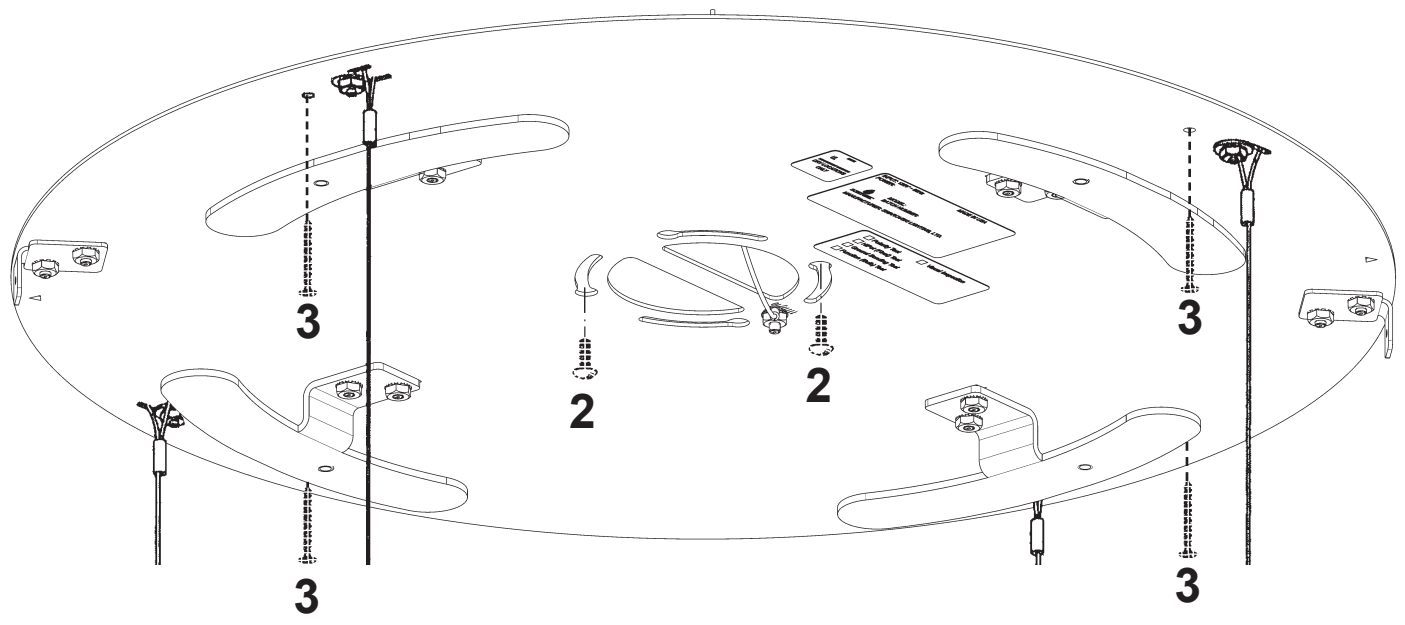
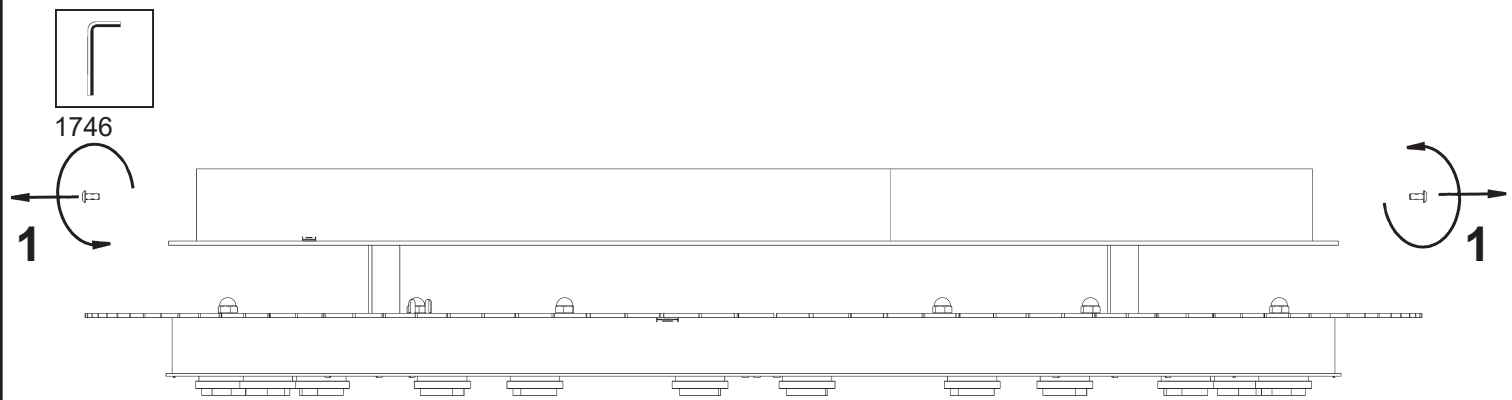

- 11 A
- 12 B
- 13 C
- 14 D

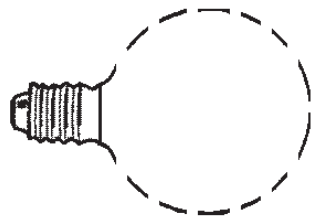

You will need 12 - G16-1/2
40 Watts Max

**Install bulbs and be sure
to test fixture BEFORE
trimming.**

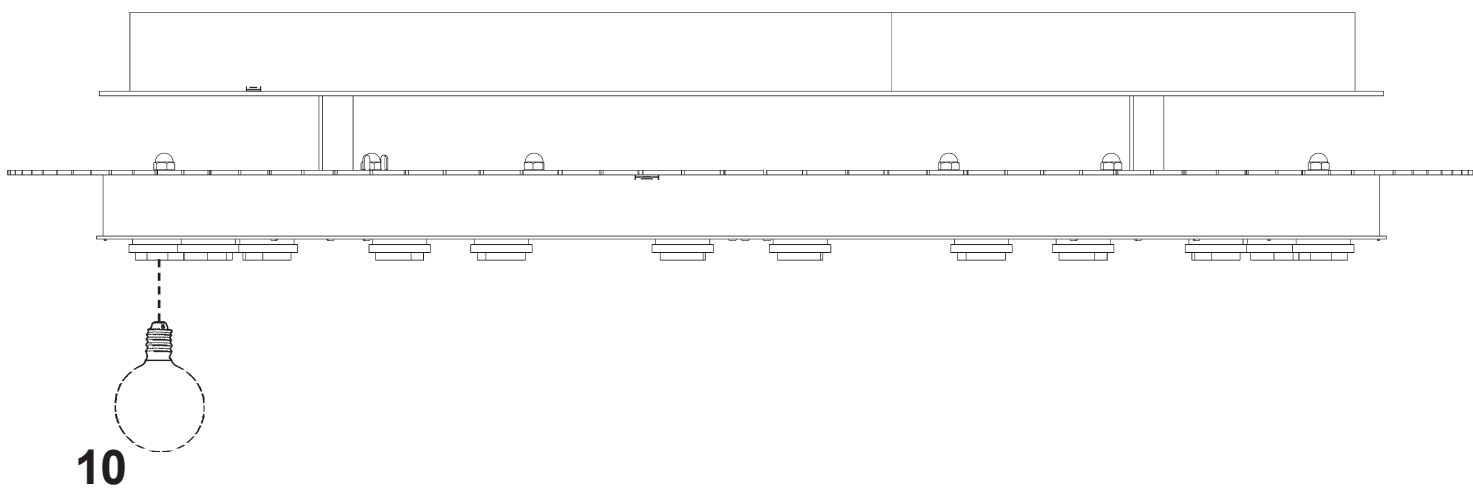

10

