

# SARELLA RS8348N- \_\_ \_\_ H

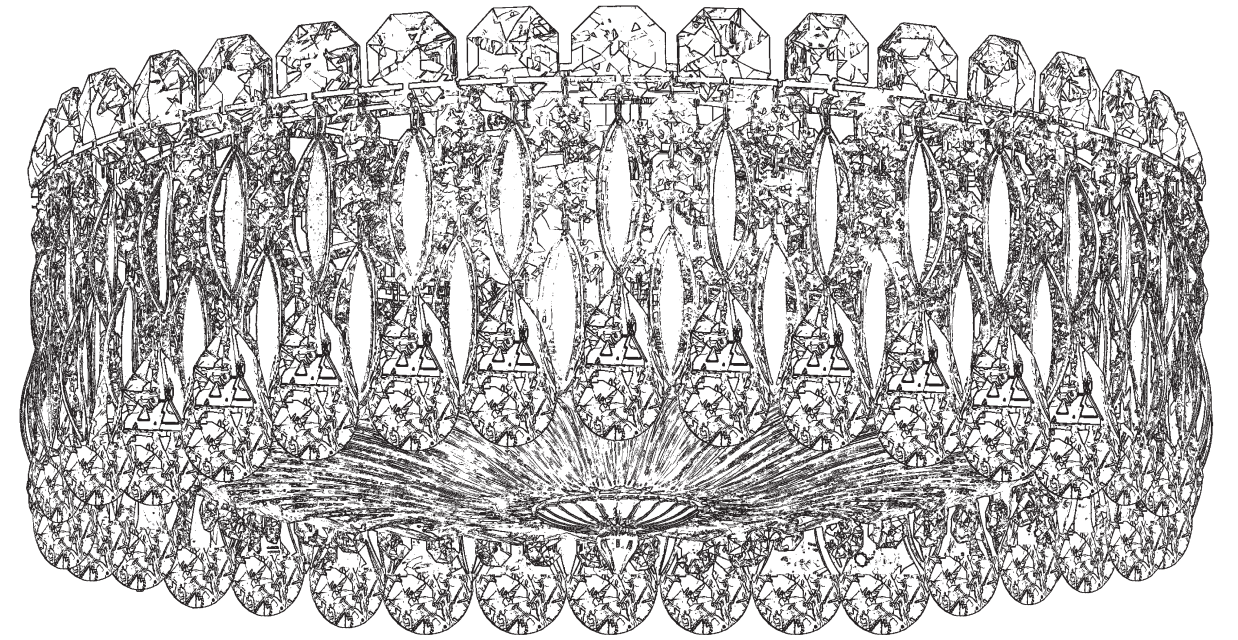











 **SCHONBEK** | 1870

**T**HIS DESIGN IS THE PROPRIETARY  
TRADE DRESS/TRADemark OF  
W SCHONBEK LLC.

3 Lights  
Diameter: 15-1/2"  
Height: 6-1/2"  
Hanging Weight: 15lbs.

 **SCHONBEK** | 1870

								
MAX <b>40</b> W	110-120 V							

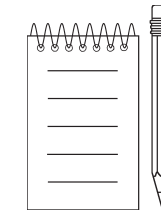
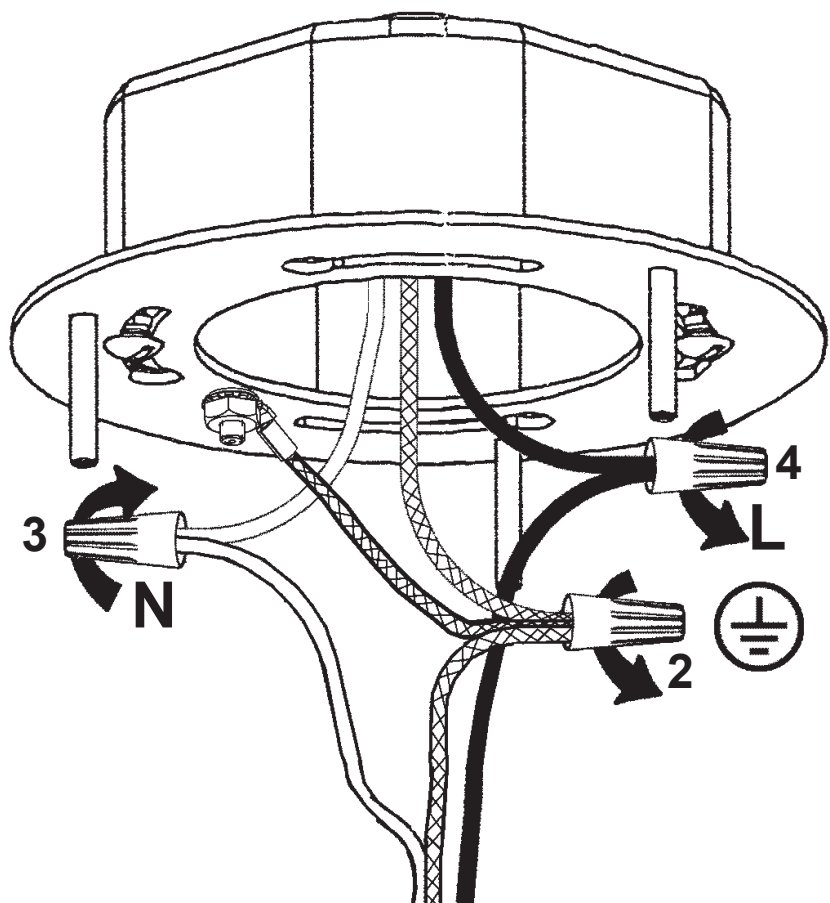
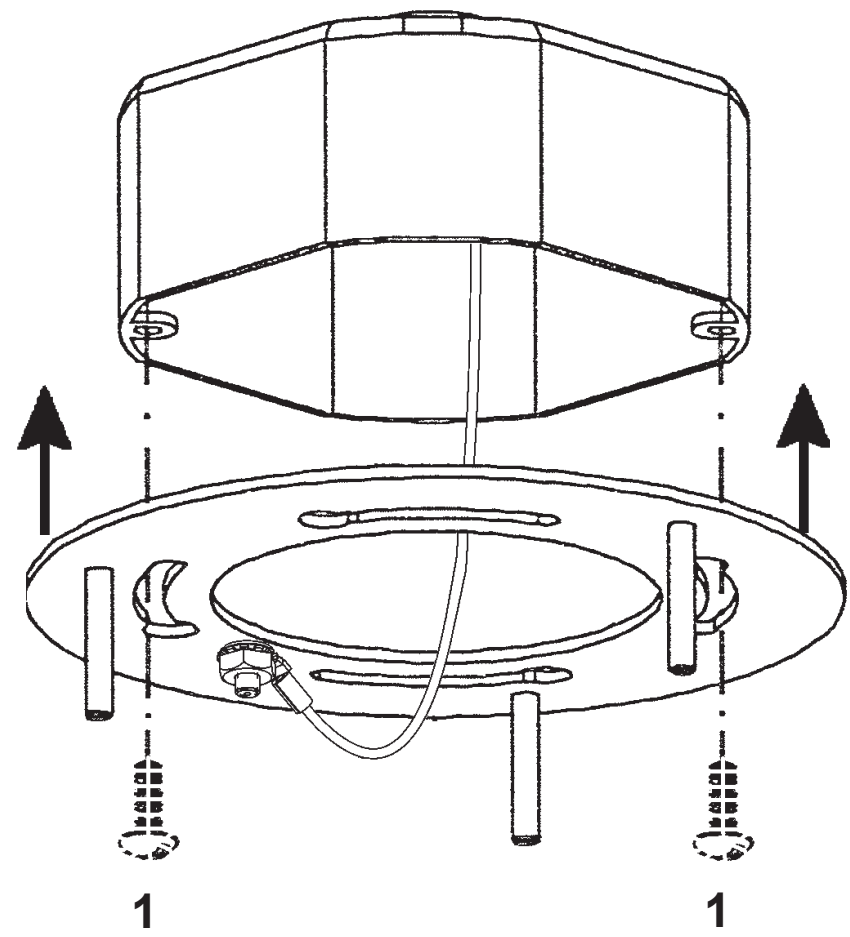

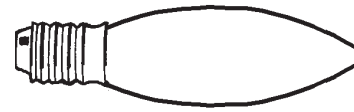
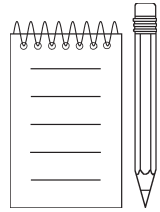

You will need 3 - B10  
40 Watts Max

**Install bulbs and be sure  
to test fixture BEFORE  
trimming.**

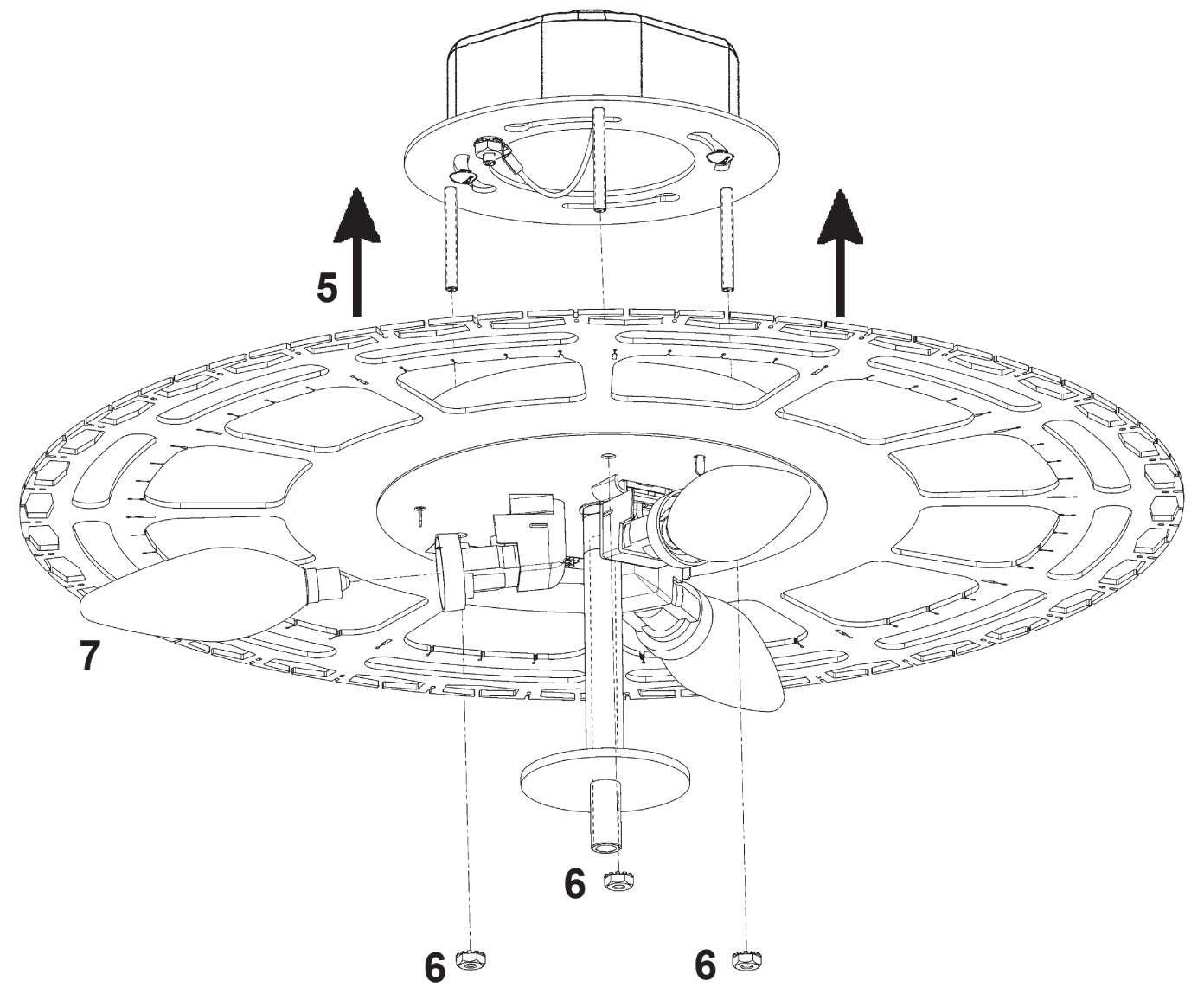

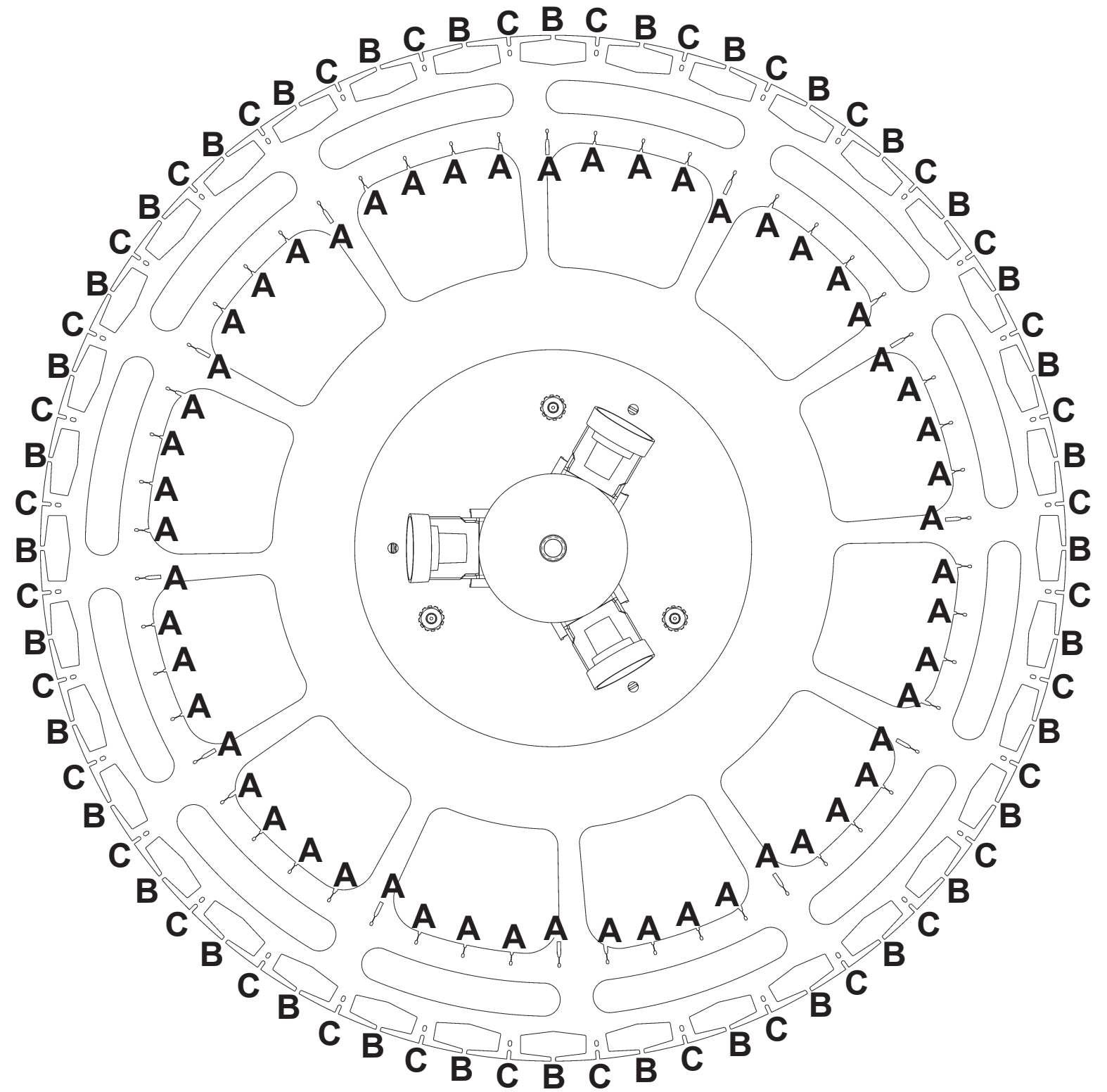
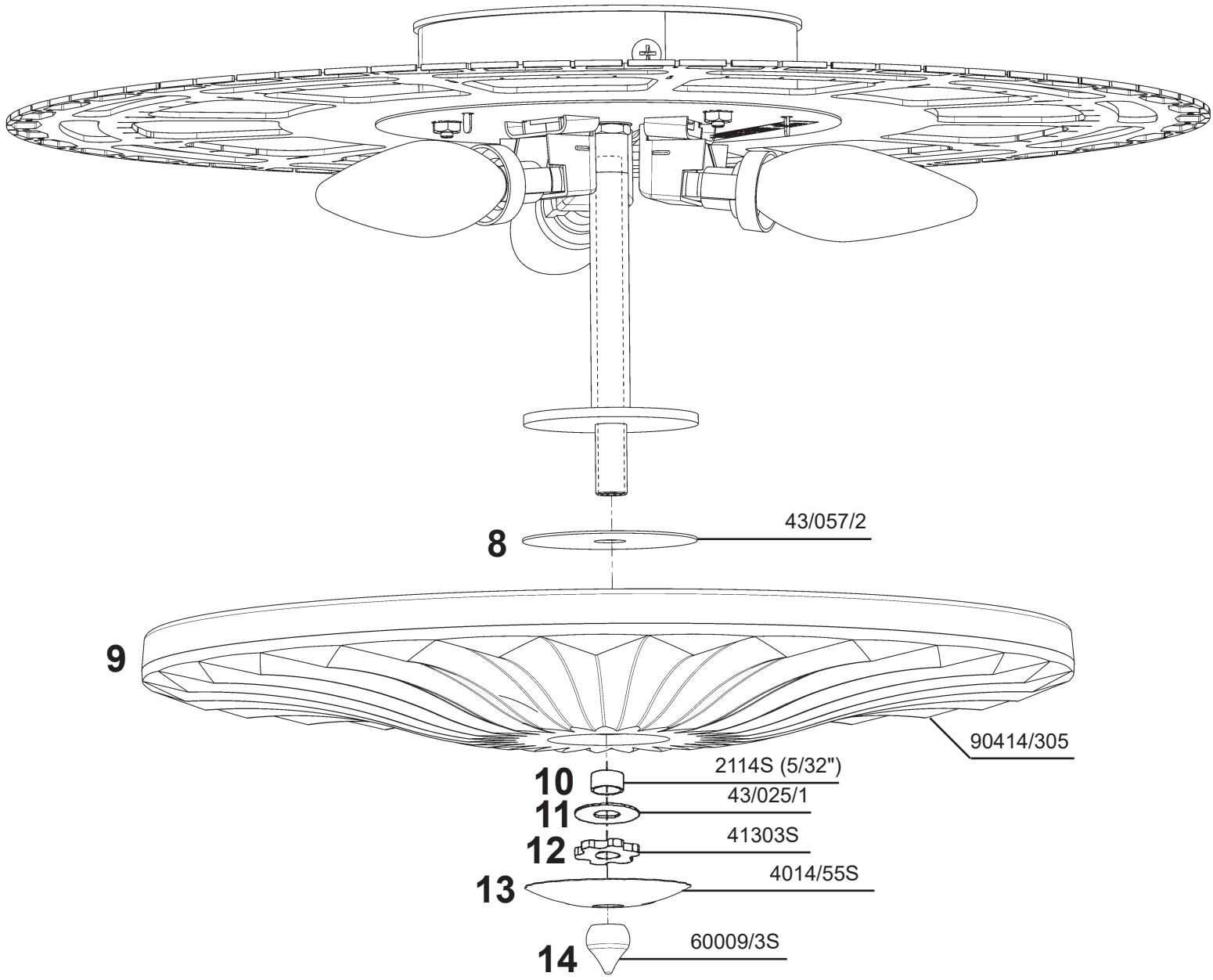

15	A
16	B
17	C





SARELLA RS8348N-\_\_ \_\_R

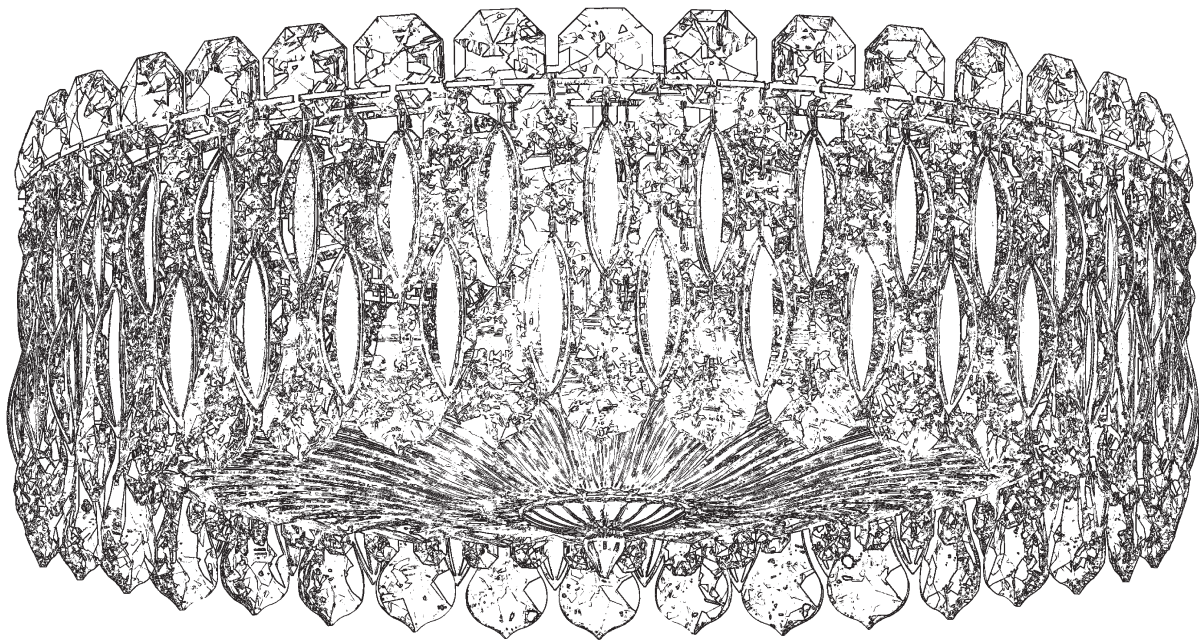











3 Lights  
Diameter: 15-1/2"  
Height: 6-1/2"  
Hanging Weight: 15lbs.

**T**HIS DESIGN IS THE PROPRIETARY  
TRADE DRESS/TRADEMARK OF  
W SCHONBEK LLC.

 **SCHONBEK** | 1870

 **SCHONBEK** | 1870

								
MAX 40 W		110-120 V						

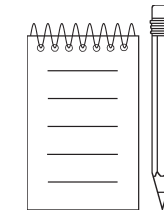
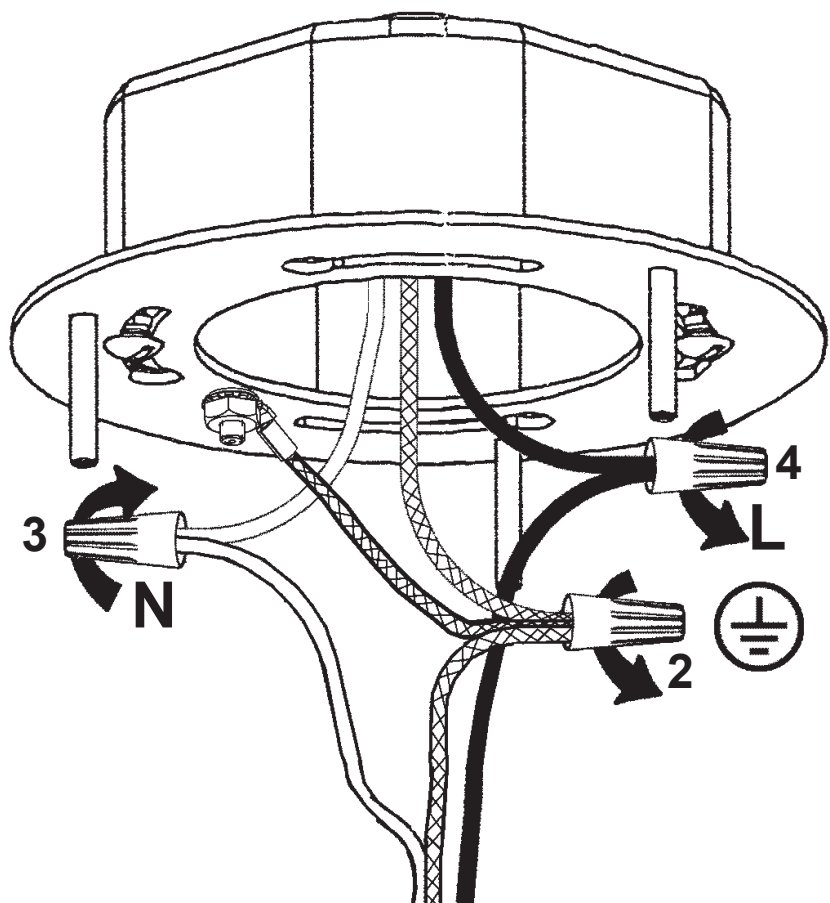
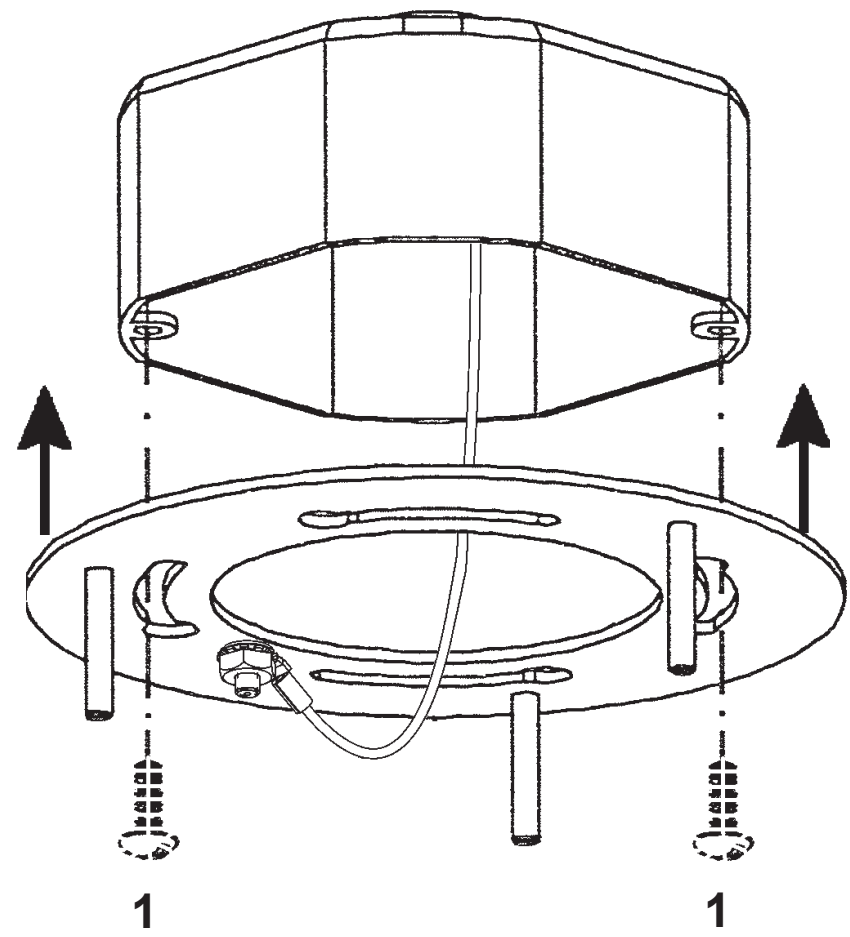

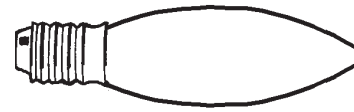
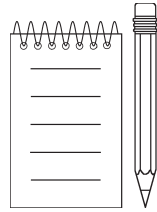

You will need 3 - B10  
40 Watts Max

**Install bulbs and be sure  
to test fixture BEFORE  
trimming.**

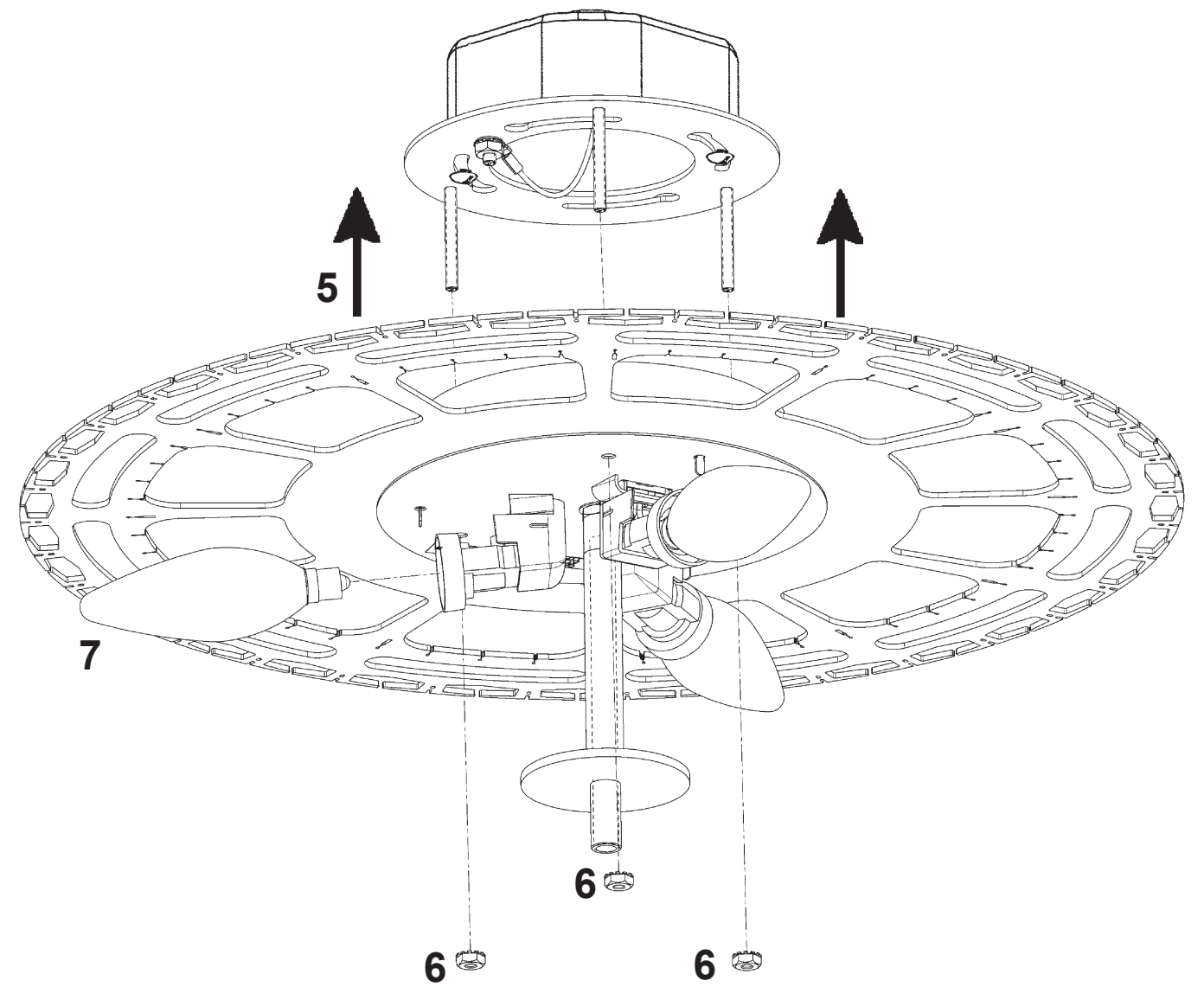

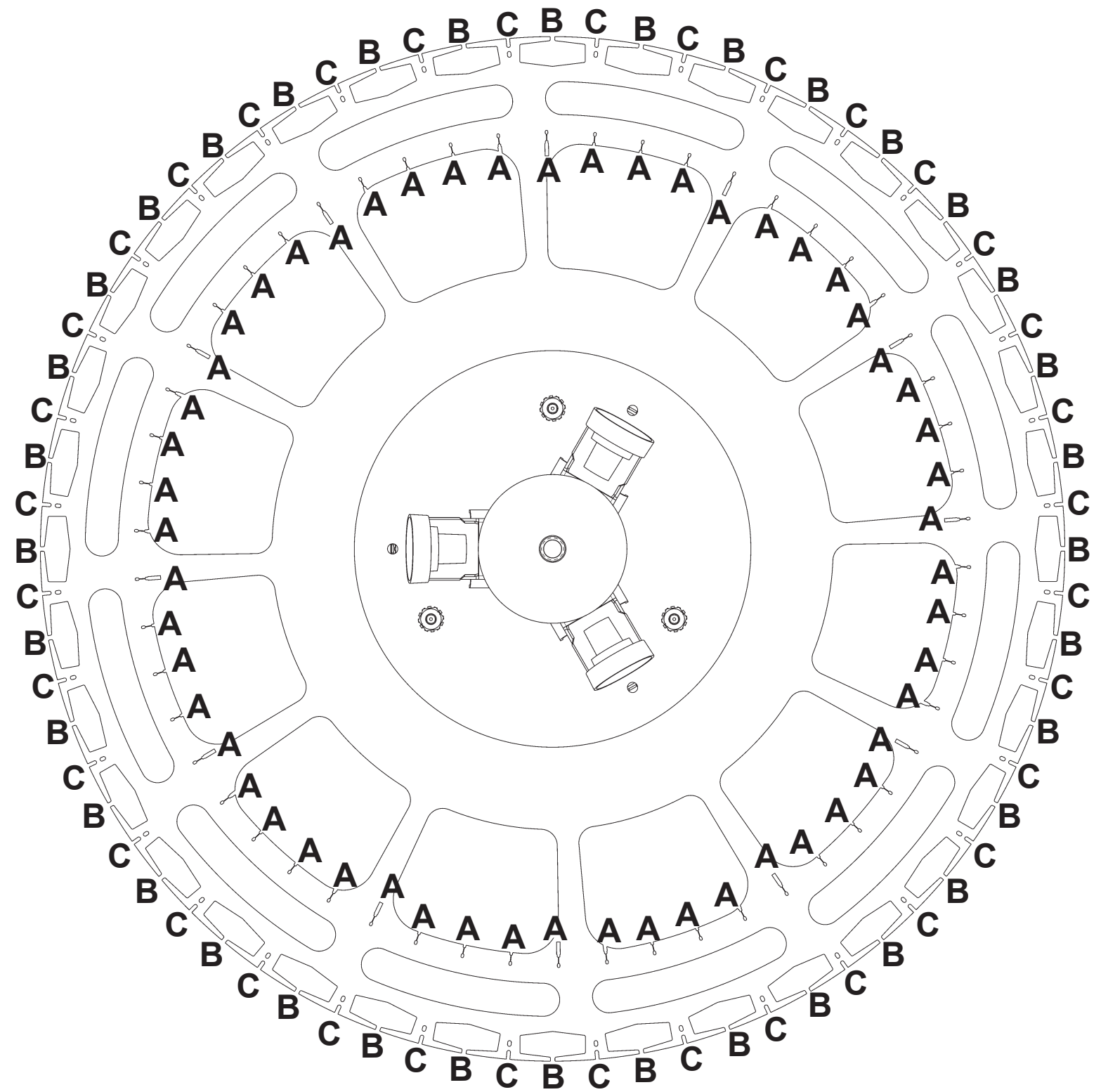
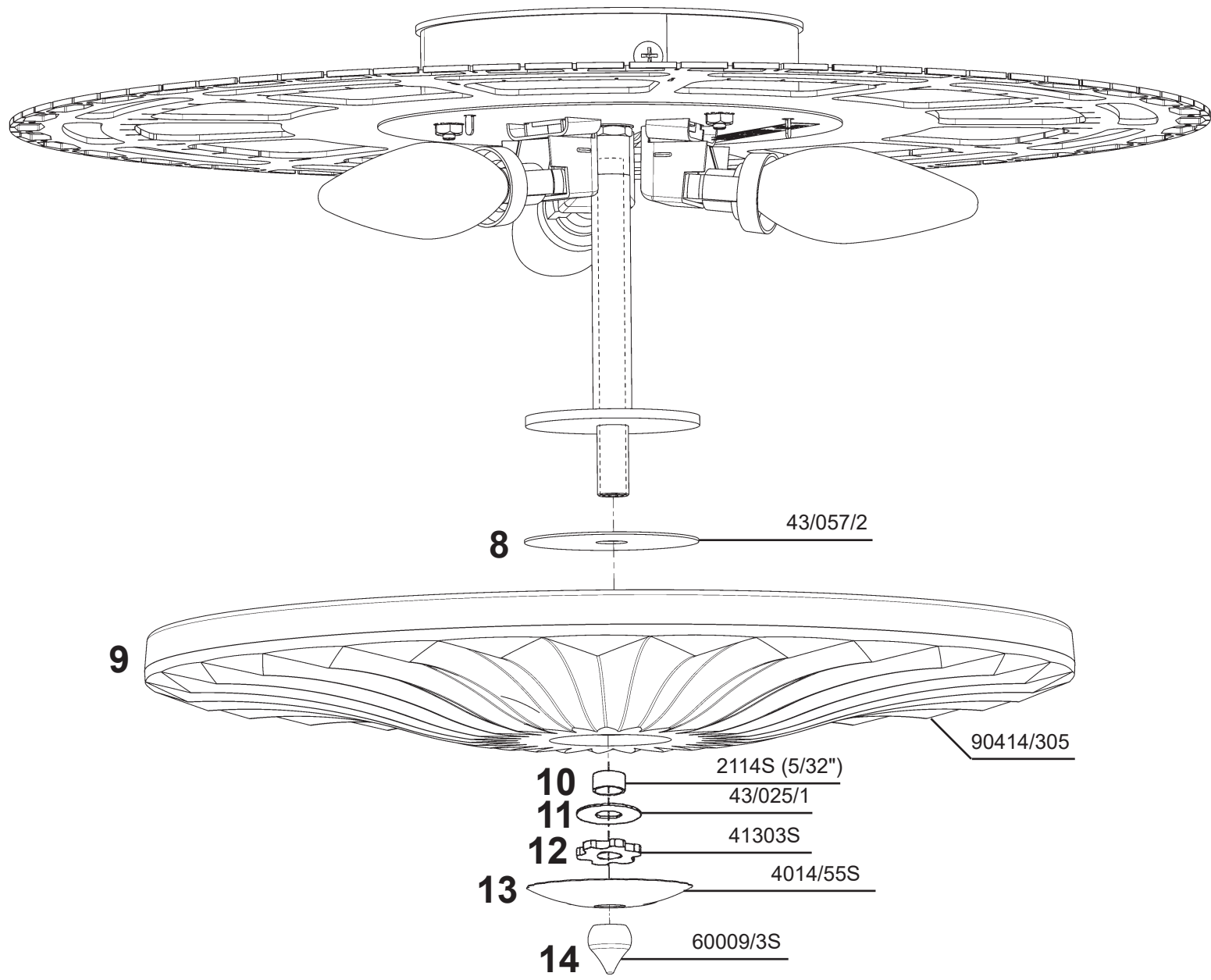

15	A
16	B
17	C





# SARELLA RS8348N-\_\_ \_\_S

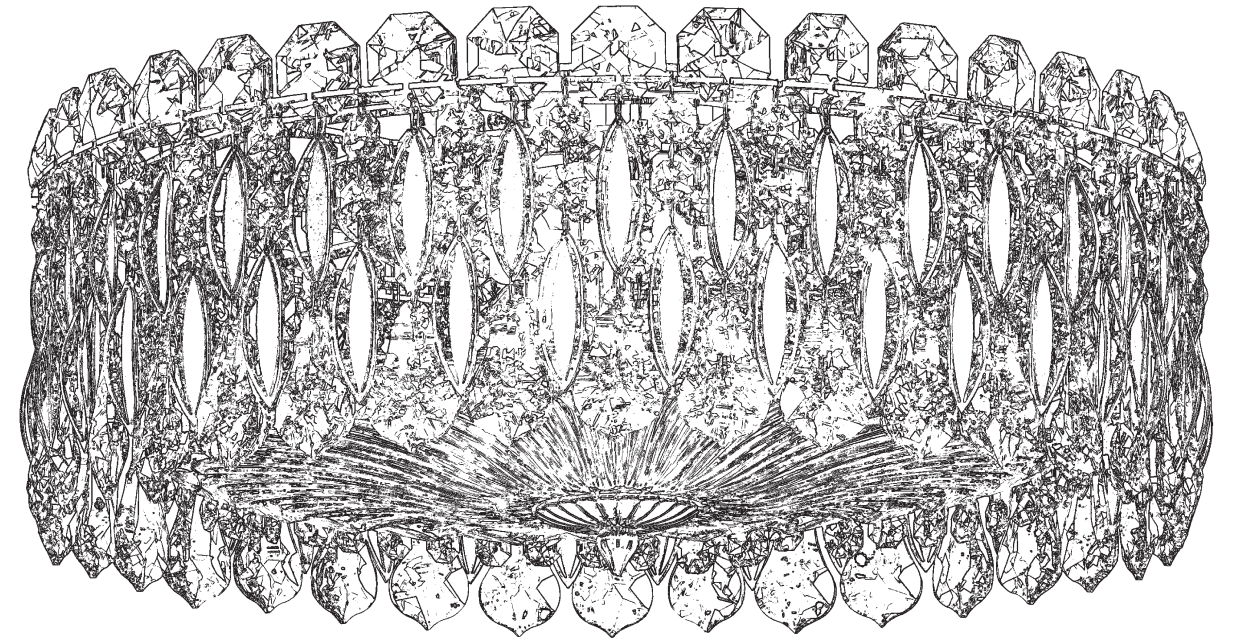











3 Lights  
Diameter: 15-1/2"  
Height: 6-1/2"  
Hanging Weight: 15lbs.

**T**HIS DESIGN IS THE PROPRIETARY  
TRADE DRESS/TRADEMARK OF  
W SCHONBEK LLC.

 **SCHONBEK** | 1870

 **SCHONBEK** | 1870

								
MAX 40 W	110-120 V							

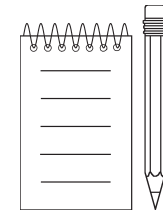
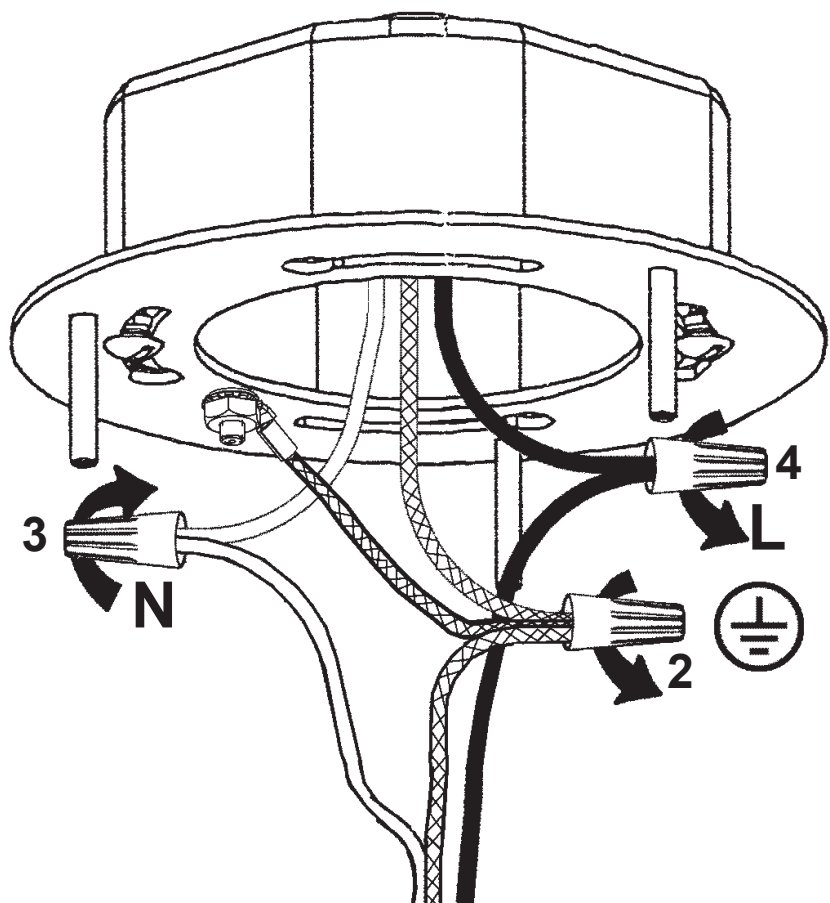
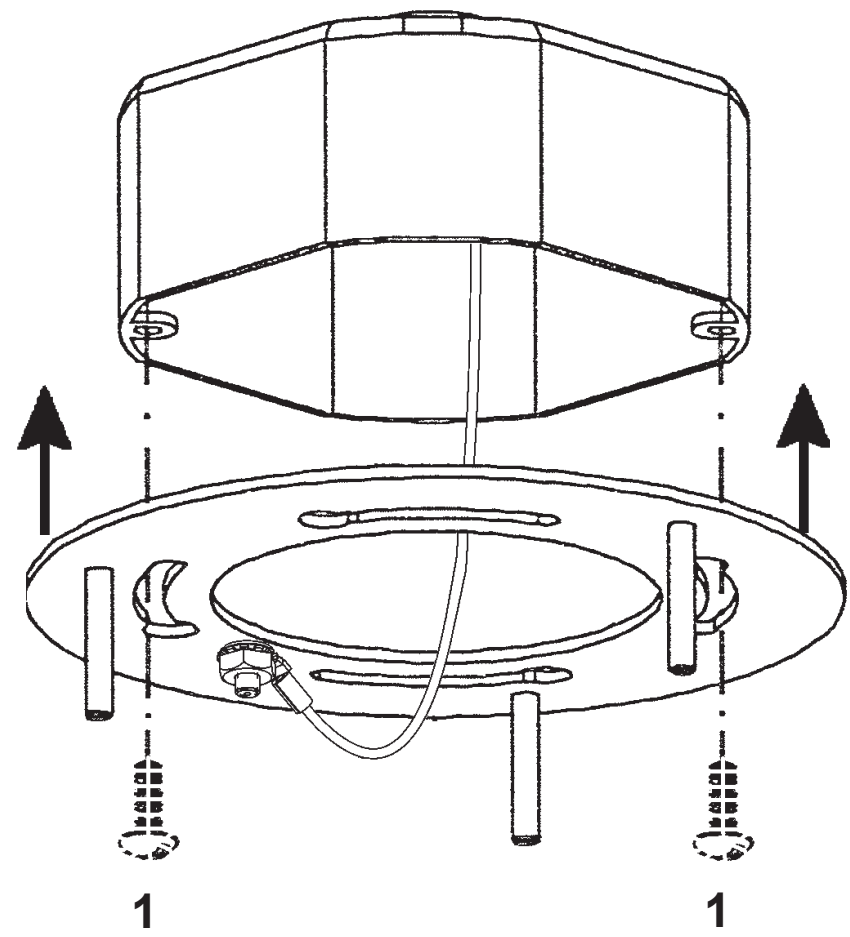

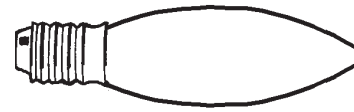
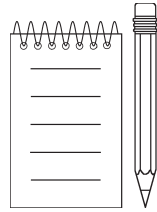

You will need 3 - B10  
40 Watts Max

**Install bulbs and be sure  
to test fixture BEFORE  
trimming.**

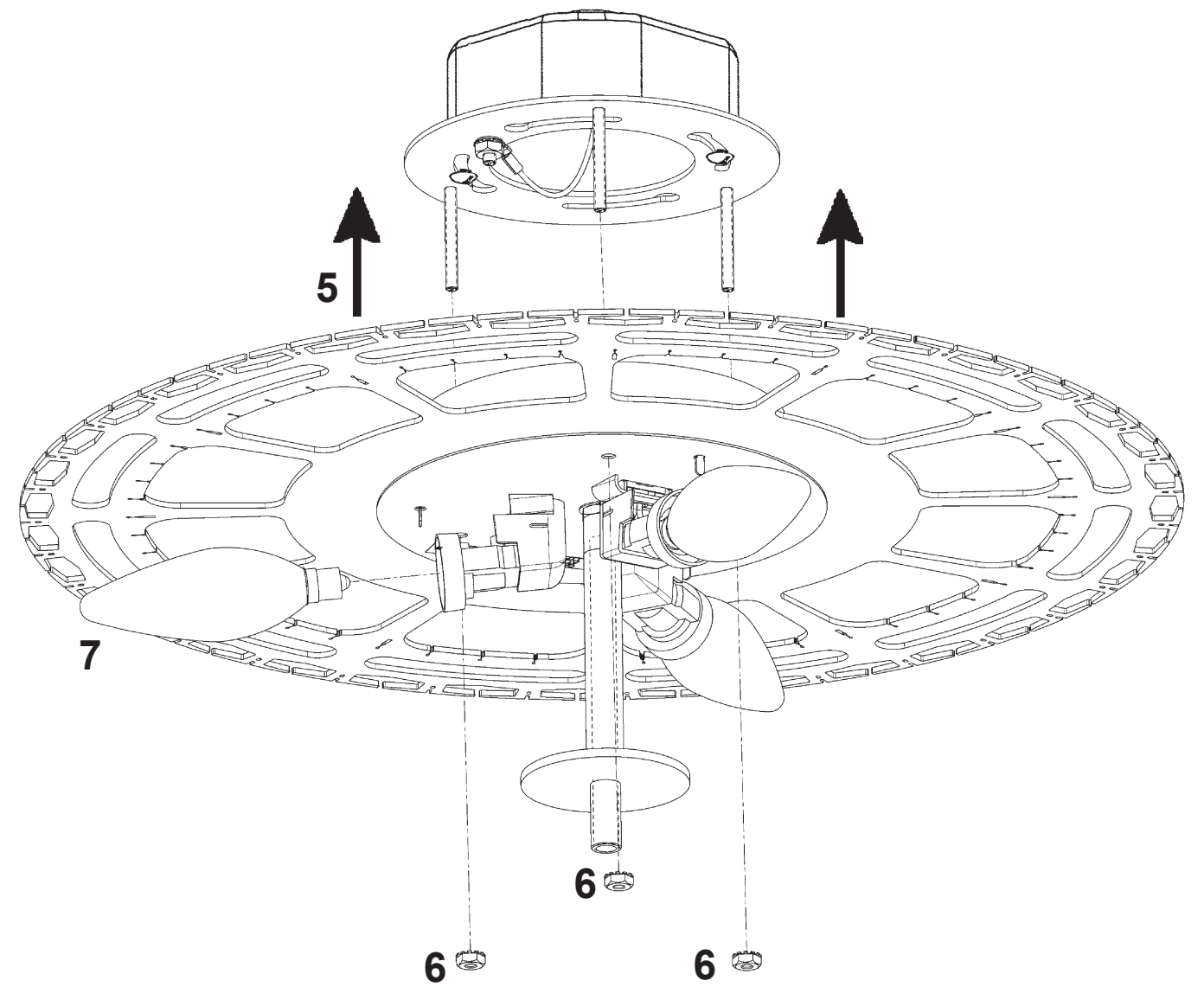

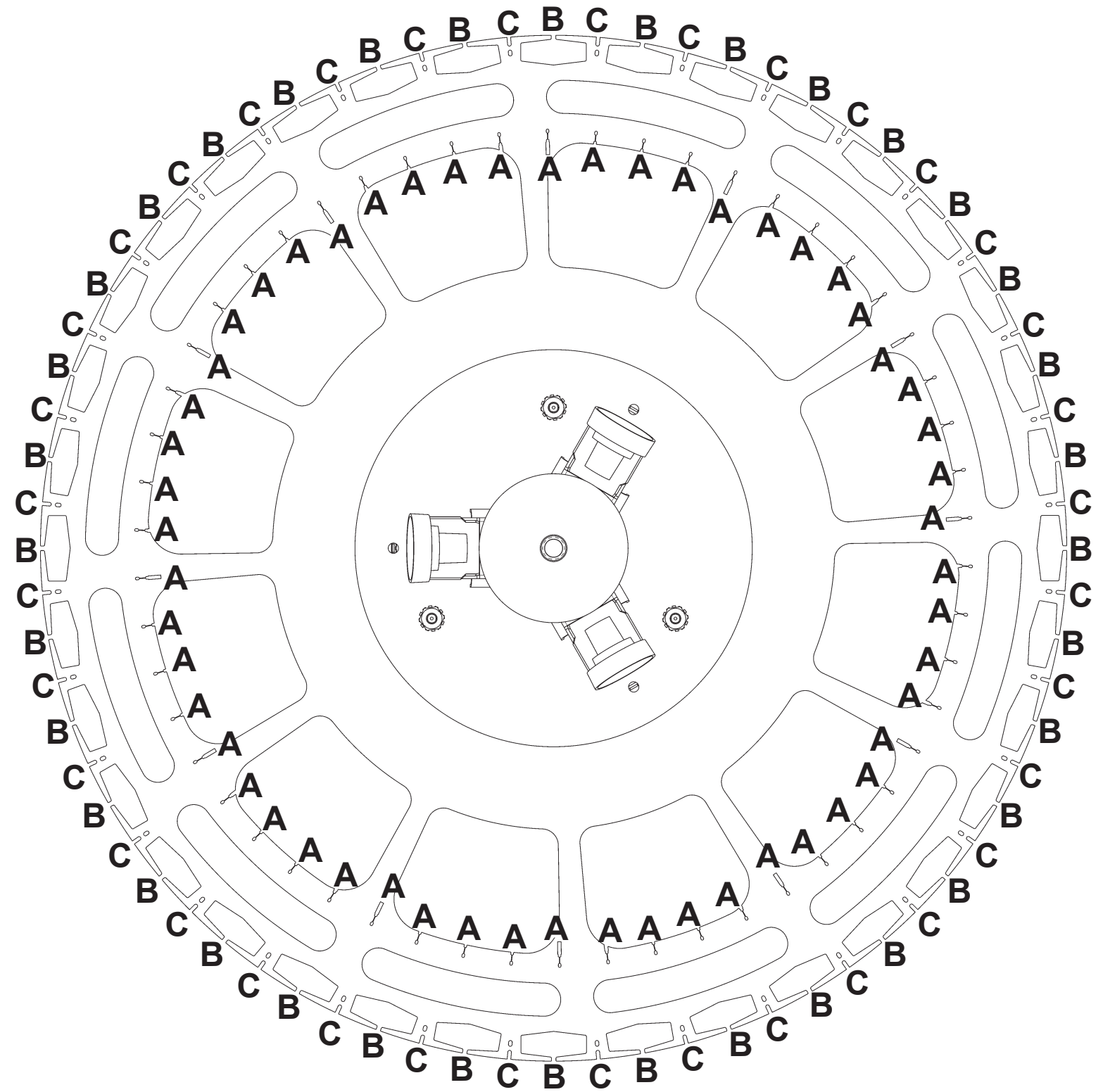
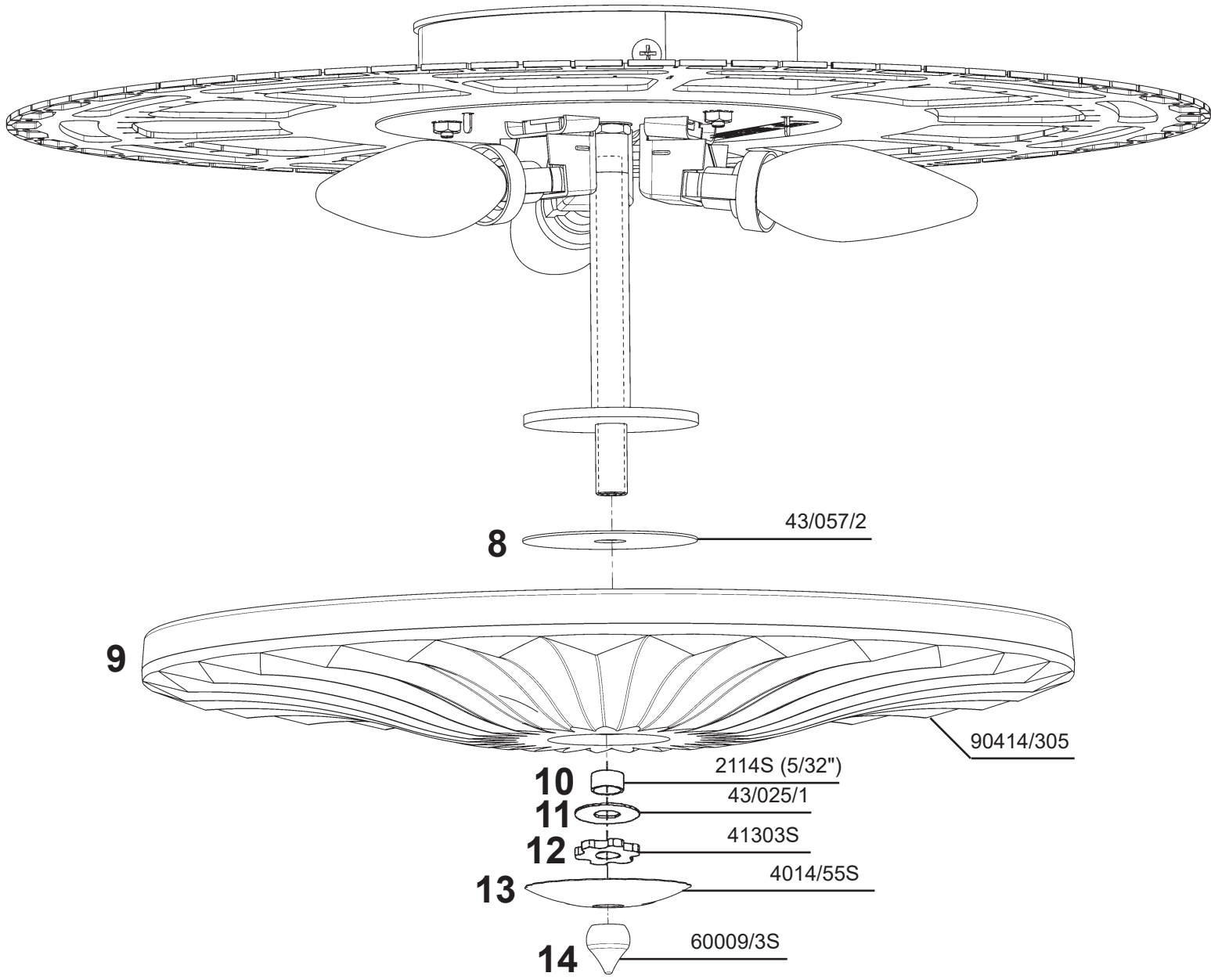

15	A
16	B
17	C

