

SARELLA RS8415N- __ __ H

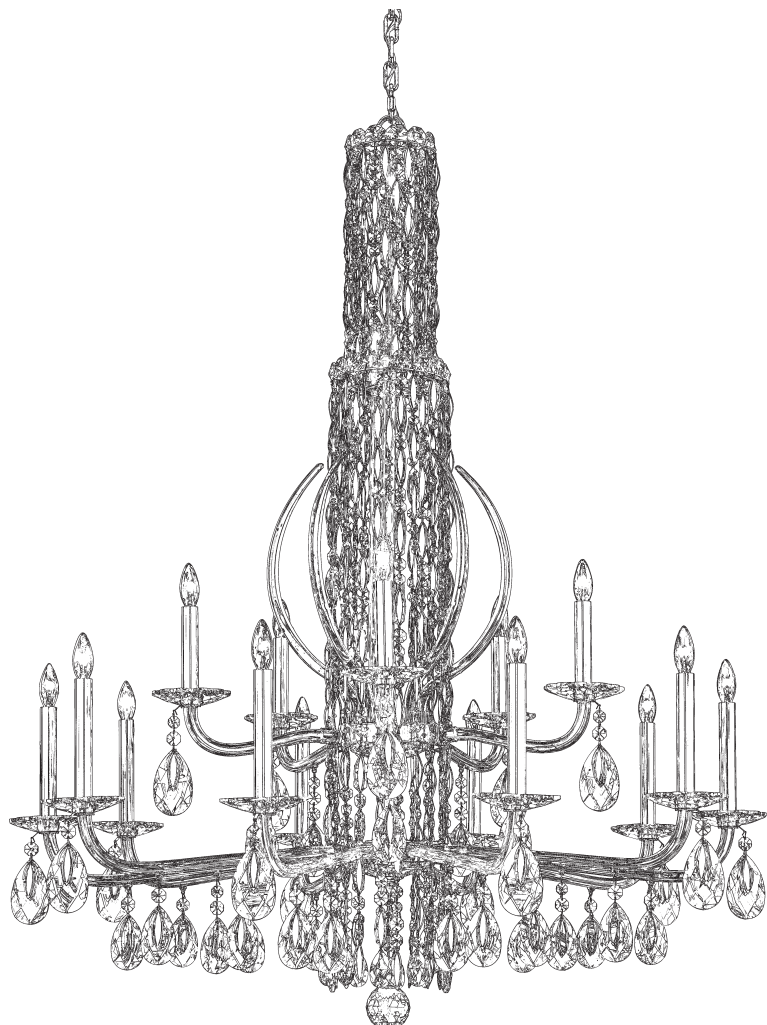











15 + 2 Lights
Diameter: 40-1/2"
Height: 50-1/2"
Hanging Weight: 44lbs.

THIS DESIGN IS THE PROPRIETARY
TRADE DRESS/TRADEMARK OF
W SCHONBEK LLC.

 **SCHONBEK** | 1870

 **SCHONBEK** | 1870

								
MAX <u>60</u> W		110-120 V						

WARNING:

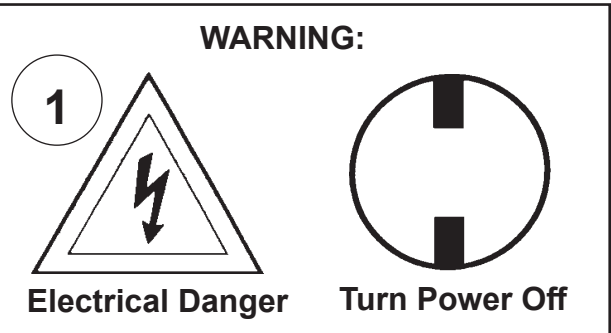
1 

Electrical Danger Turn Power Off

All electrical components must be installed by a licensed electrician in accordance with the National Electric Code and the appropriate local electrical codes.

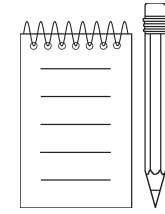
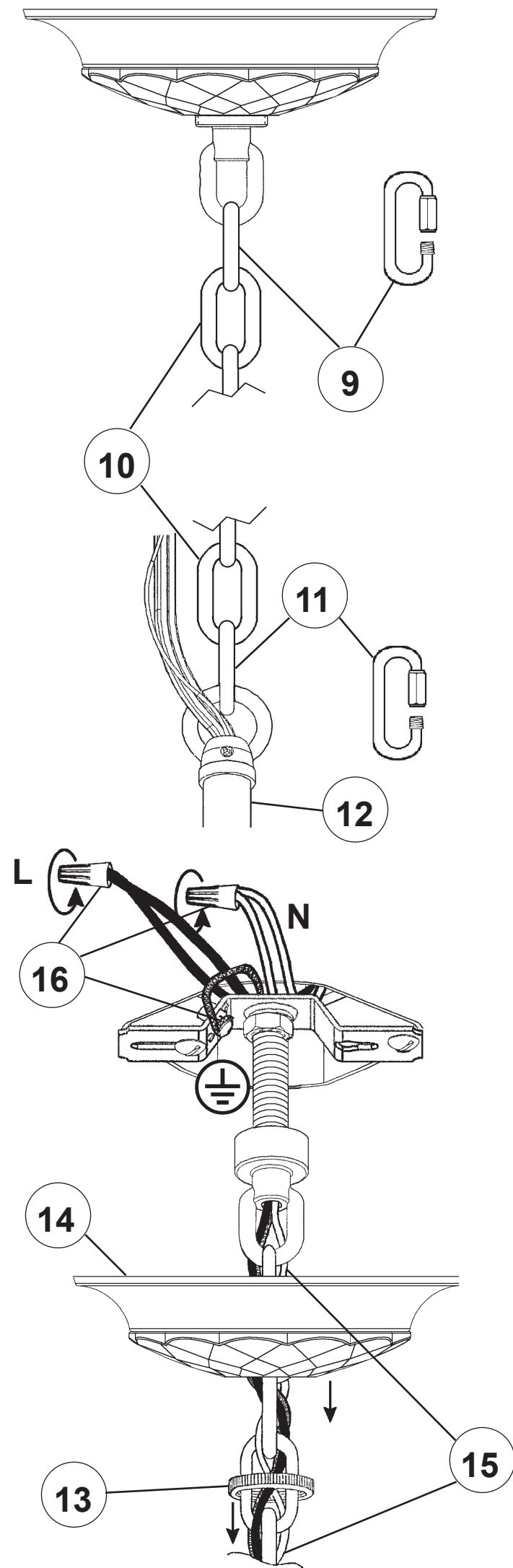
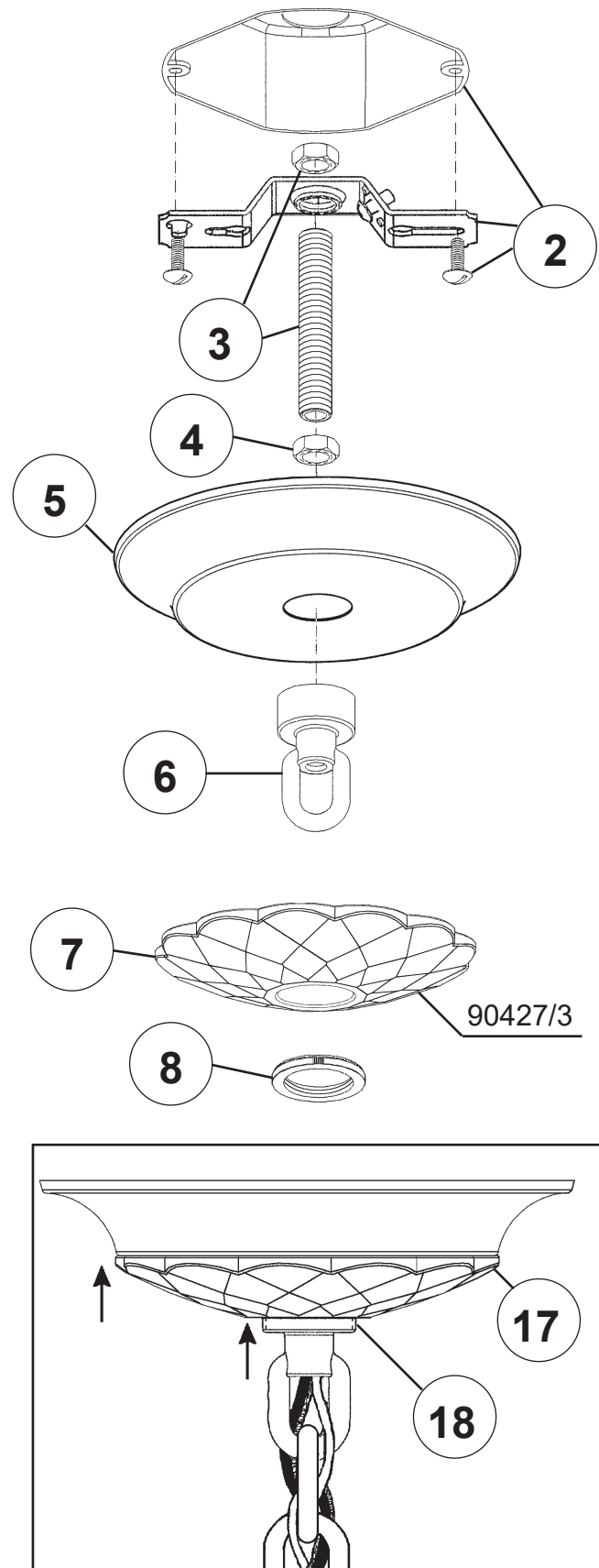

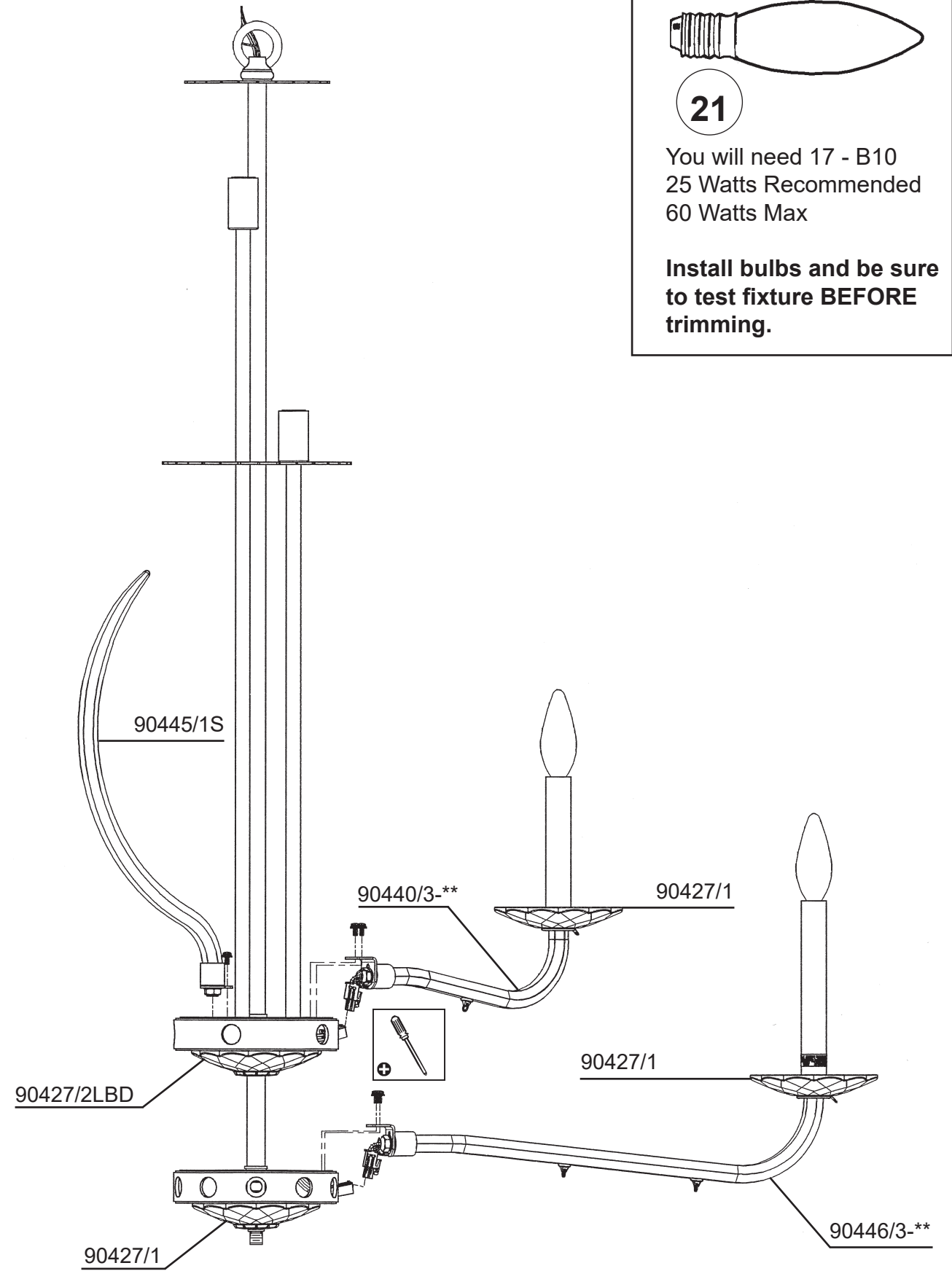

19 Connect arm wires using plug-in connectors. See detailed illustration.

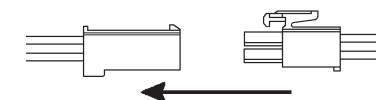

20 Push wires into hole and attach arm into place by tightening screws.

21 Install bobecbe on every arm and screw bulbs into all sockets and test fixture before trimming. If any of the bulbs do NOT light - DISCONNECT POWER. Double check the wire connections.

22 Install scroll(s) into hole pattern in washer. Tighten screw to secure scroll(s) in place.

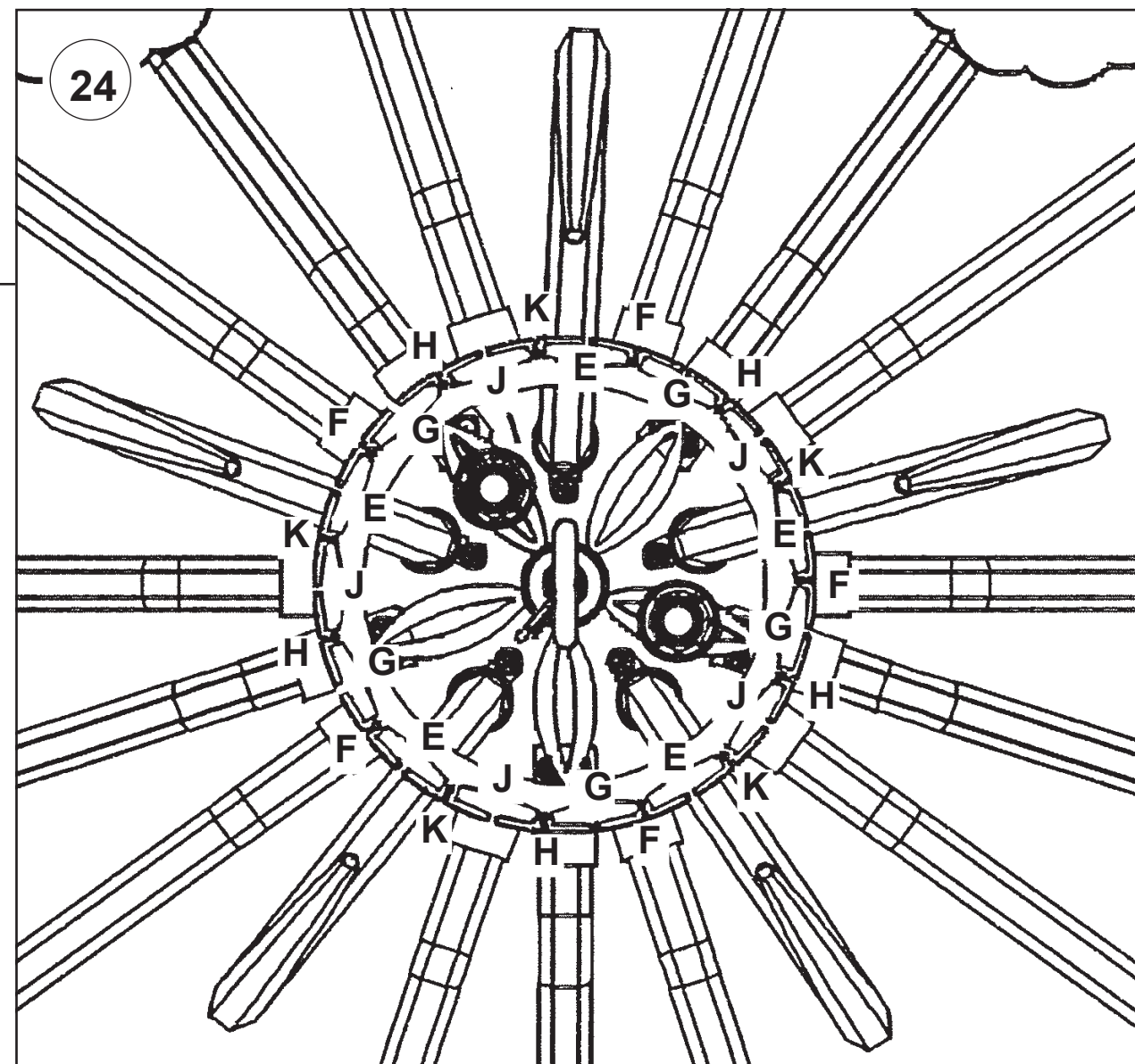
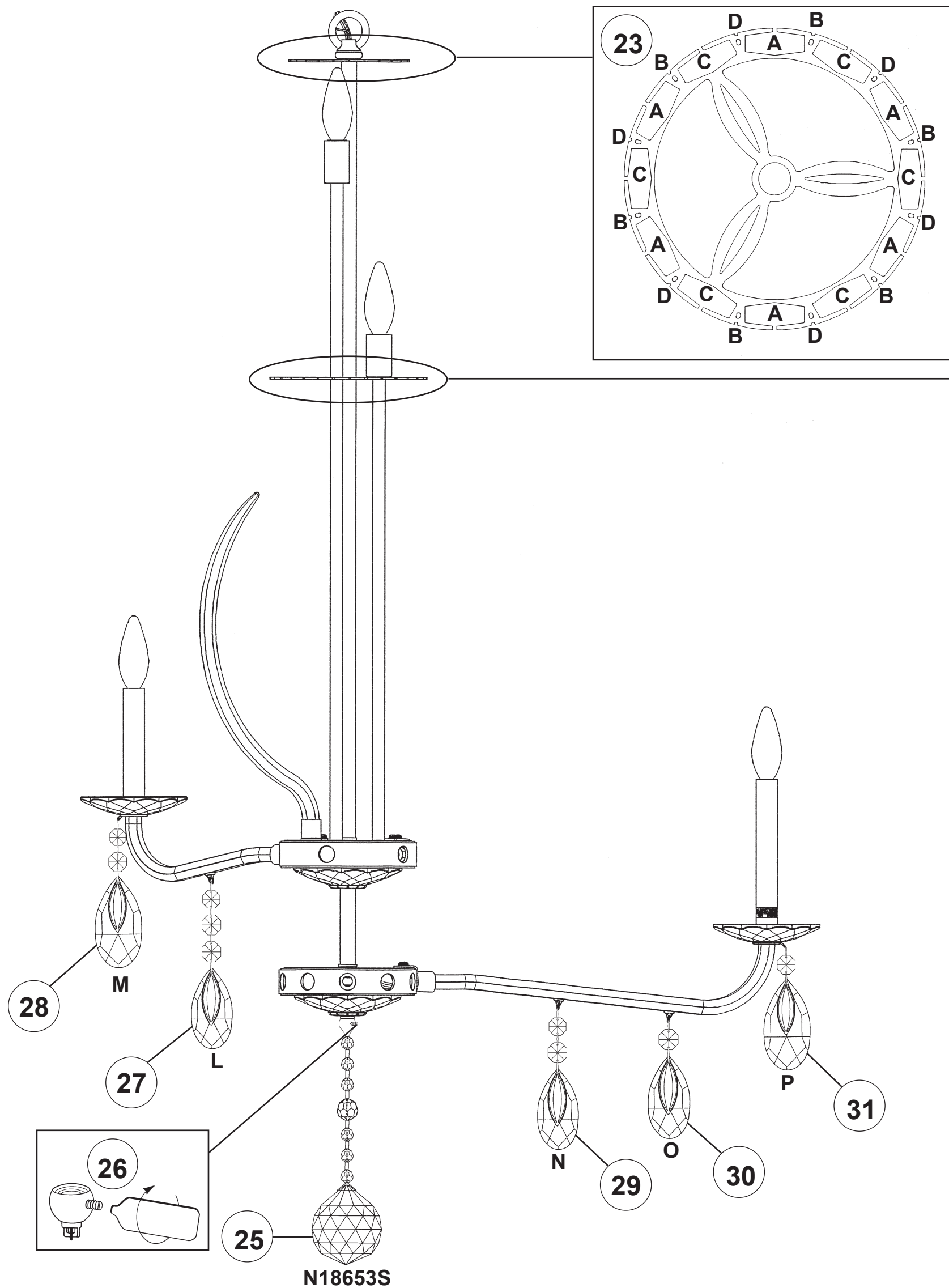

SARELLA RS8415N-__ __R

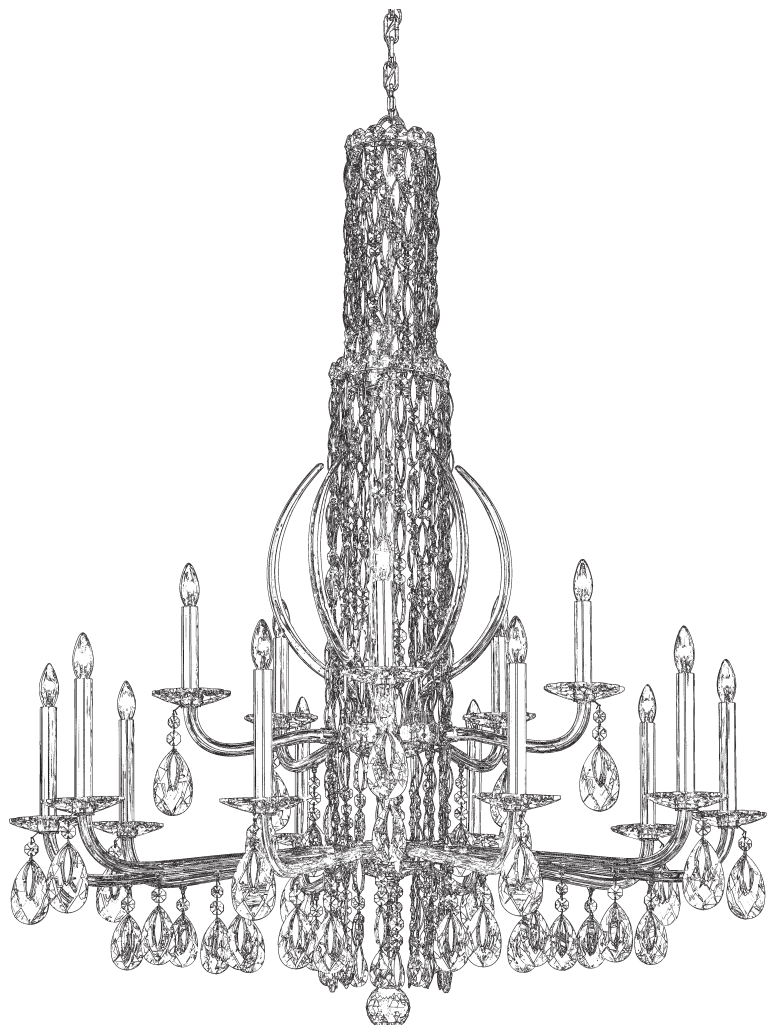











15 + 2 Lights
Diameter: 40-1/2"
Height: 50-1/2"
Hanging Weight: 44lbs.

THIS DESIGN IS THE PROPRIETARY
TRADE DRESS/TRADEMARK OF
W SCHONBEK LLC.

 **SCHONBEK** | 1870

 **SCHONBEK** | 1870

								
MAX 60 W	110-120 V							

WARNING:

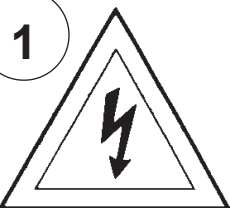
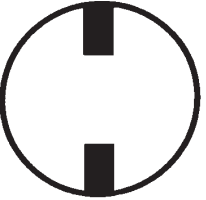
1  

Electrical Danger Turn Power Off

All electrical components must be installed by a licensed electrician in accordance with the National Electric Code and the appropriate local electrical codes.

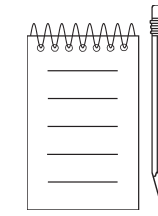
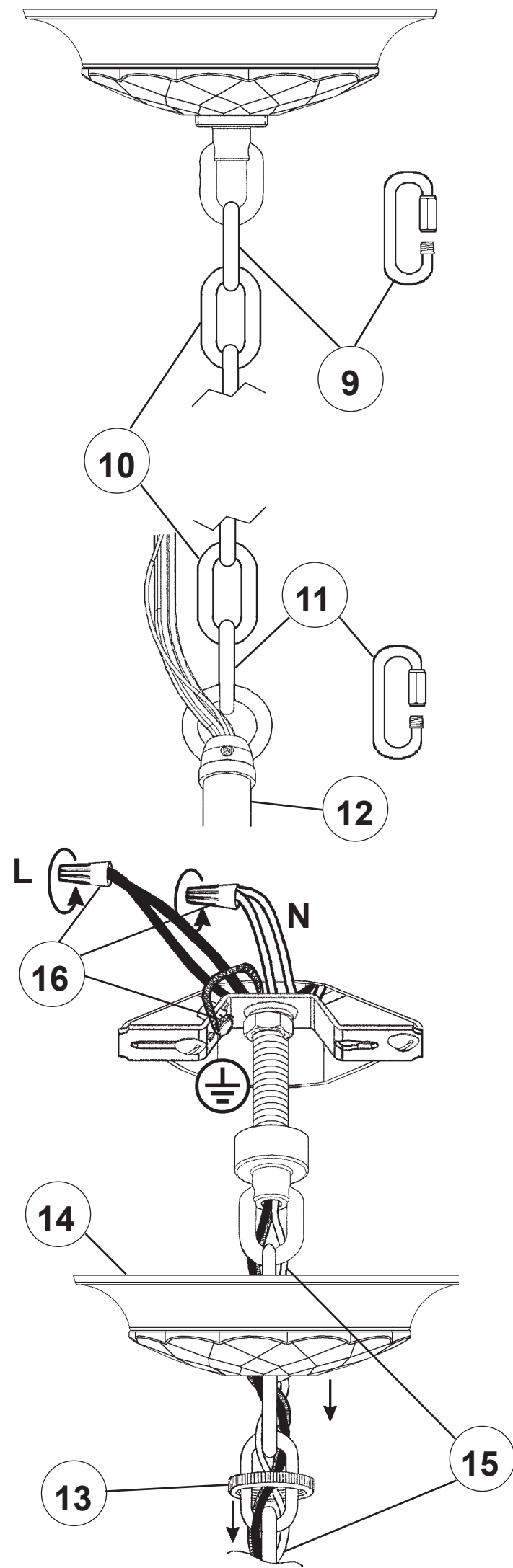
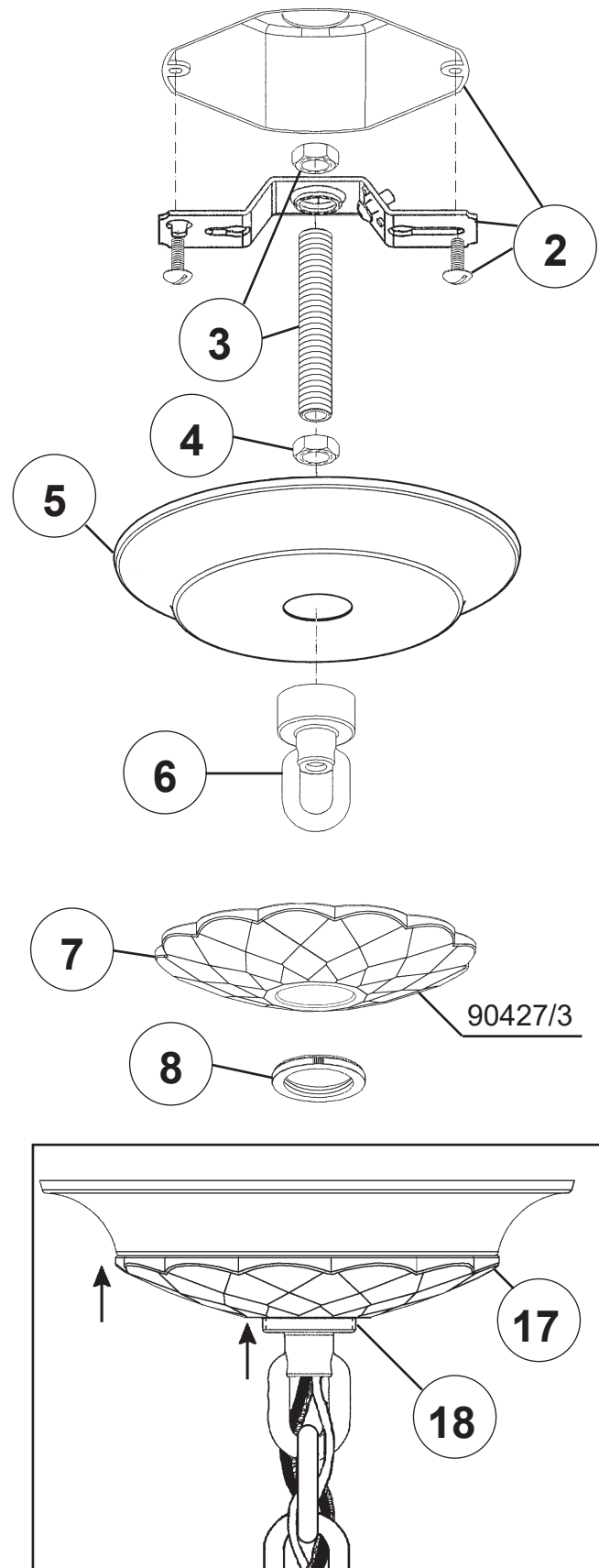

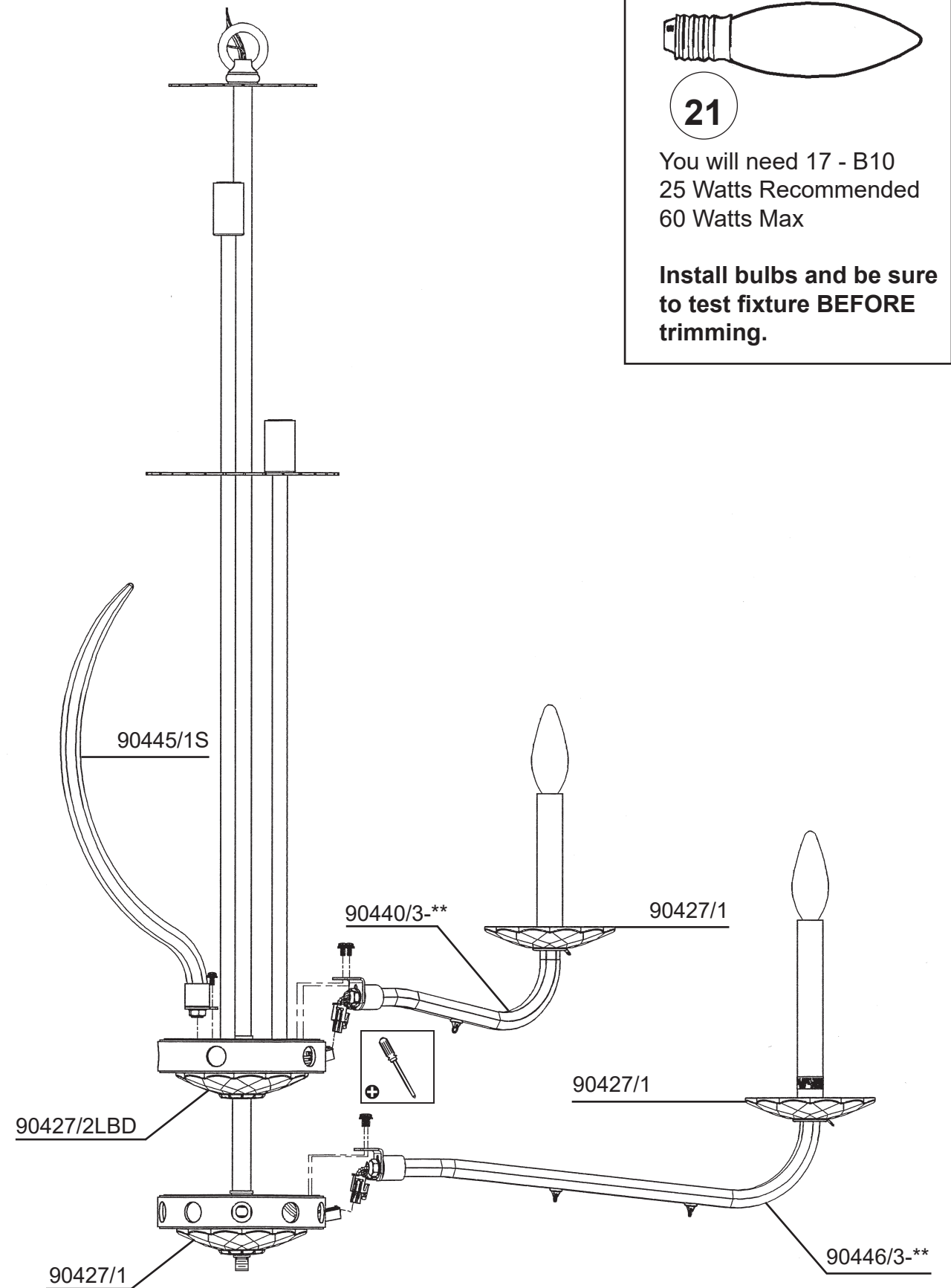
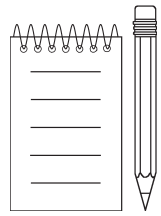

21
You will need 17 - B10
25 Watts Recommended
60 Watts Max

**Install bulbs and be sure
to test fixture BEFORE
trimming.**

19 Connect arm wires using plug-in connectors. See detailed illustration.

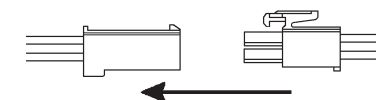

20 Push wires into hole and attach arm into place by tightening screws.

21 Install bobèche on every arm and screw bulbs into all sockets and test fixture before trimming. If any of the bulbs do NOT light - DISCONNECT POWER. Double check the wire connections.

22 Install scroll(s) into hole pattern in washer. Tighten screw to secure scroll(s) in place.

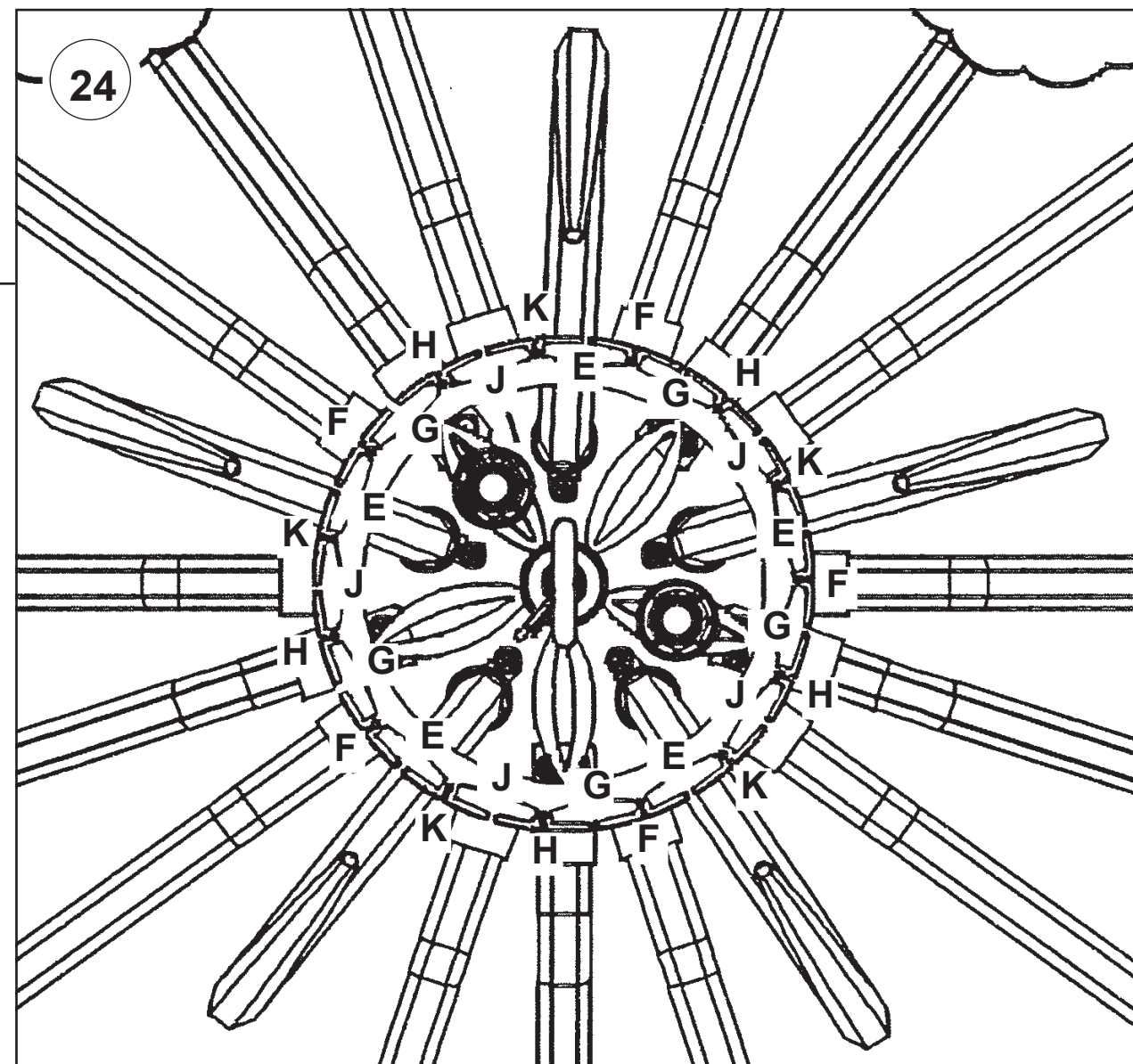
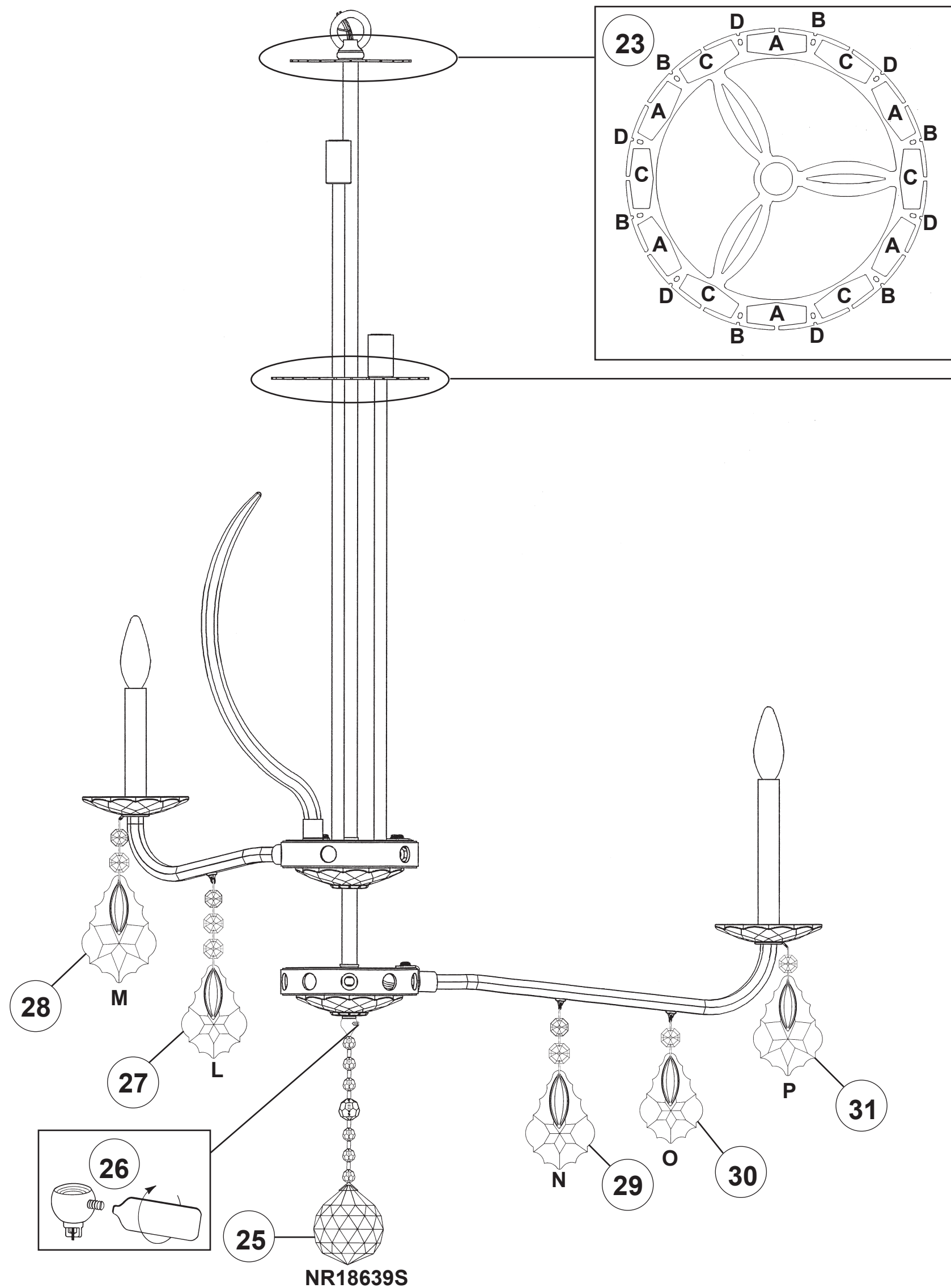

NR18639S



SARELLA RS8415N-__ __S

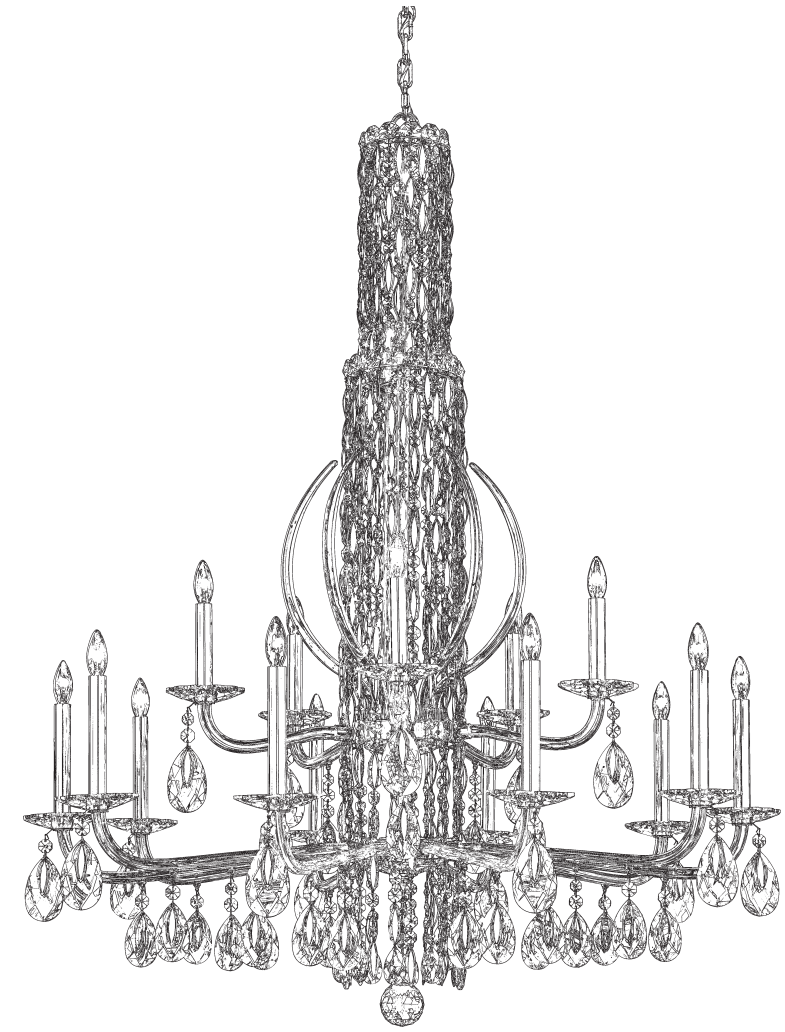











15 + 2 Lights
Diameter: 40-1/2"
Height: 50-1/2"
Hanging Weight: 44lbs.

THIS DESIGN IS THE PROPRIETARY
TRADE DRESS/TRADEMARK OF
W SCHONBEK LLC.

 **SCHONBEK** | 1870

 **SCHONBEK** | 1870

								
MAX 60 W	110-120 V							

WARNING:

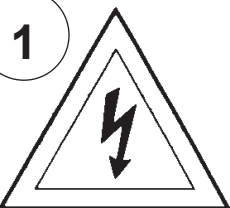
1 

Electrical Danger Turn Power Off

All electrical components must be installed by a licensed electrician in accordance with the National Electric Code and the appropriate local electrical codes.

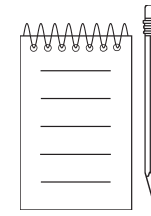
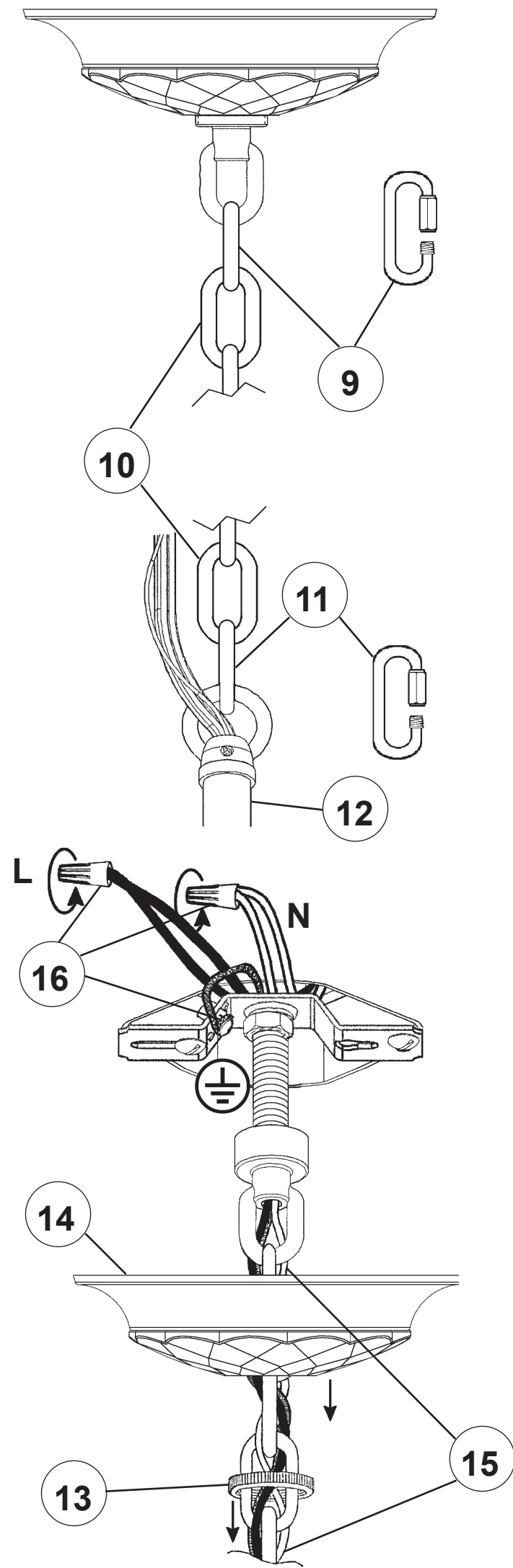
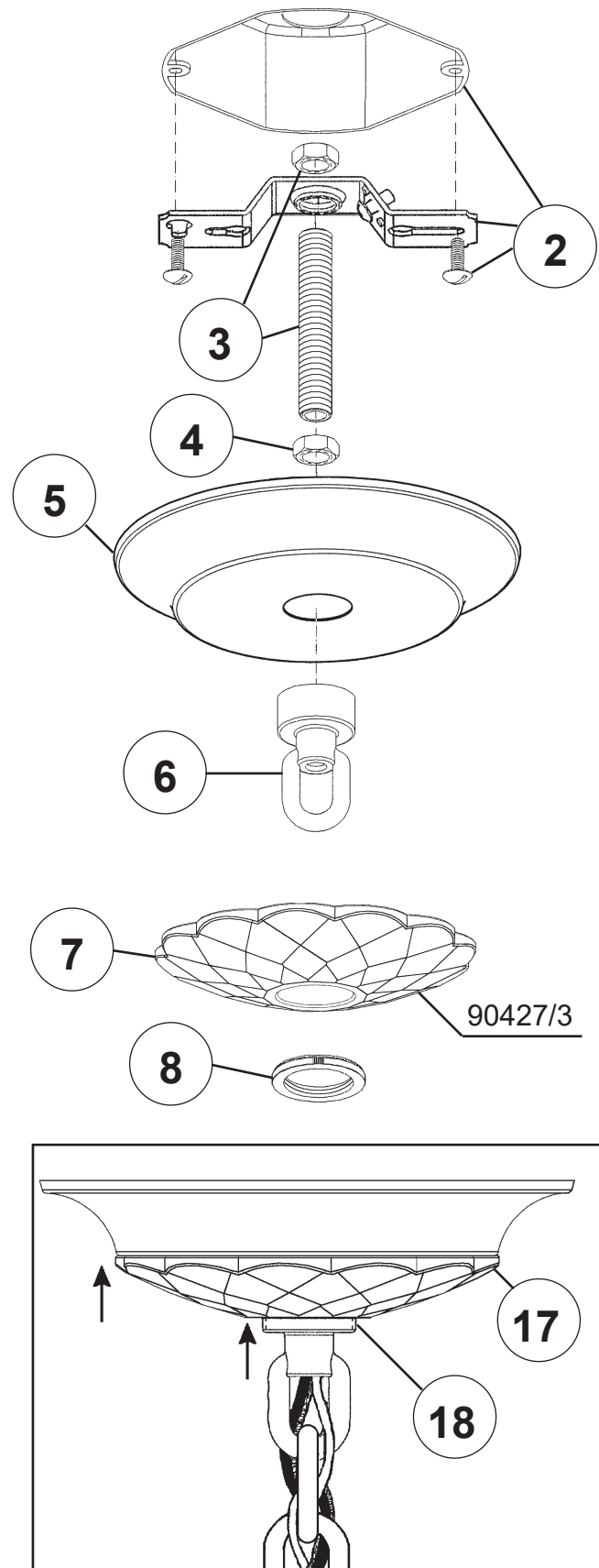

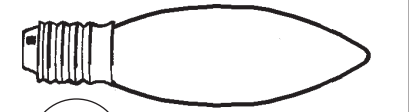
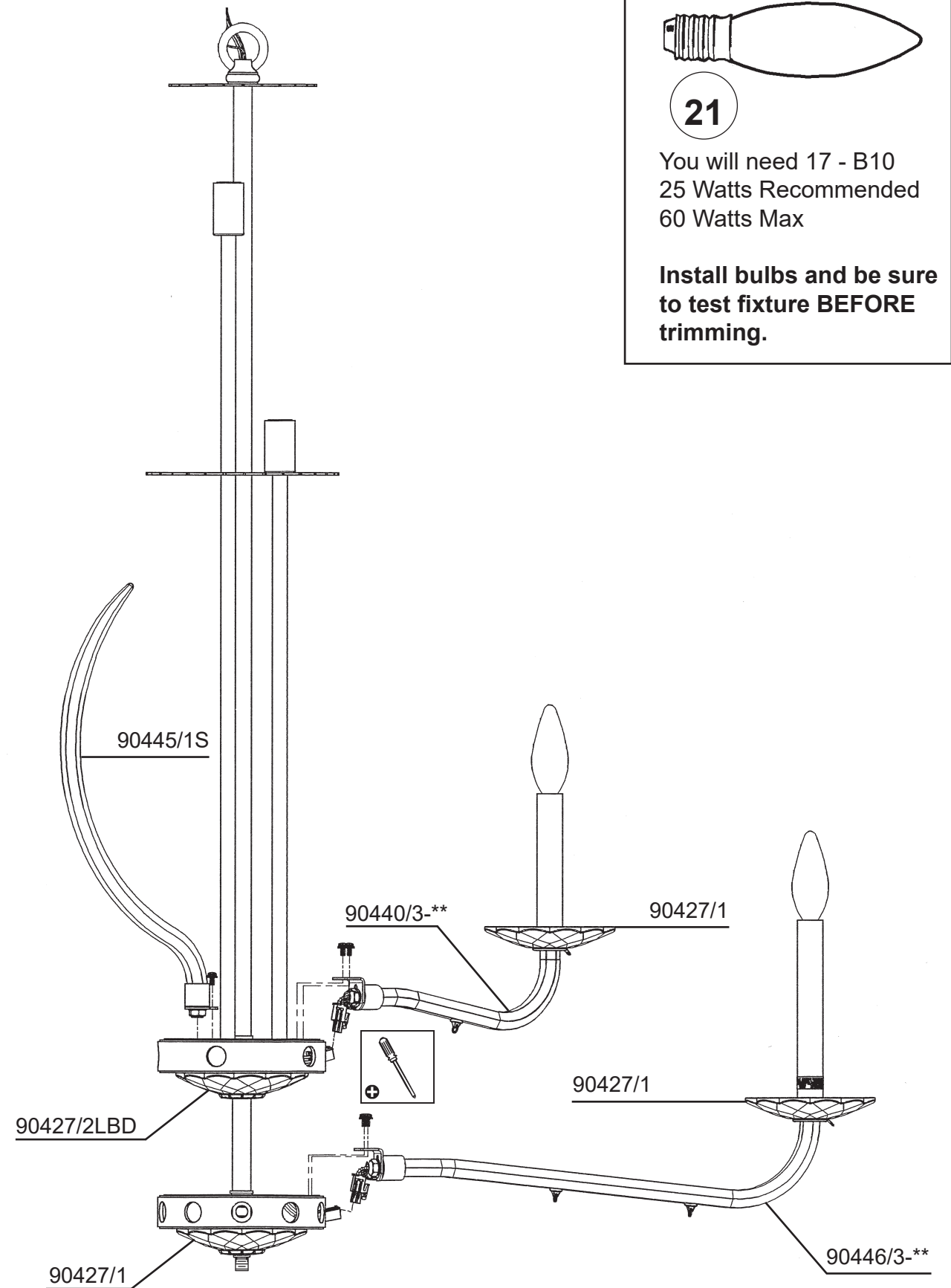

21

You will need 17 - B10
25 Watts Recommended
60 Watts Max

**Install bulbs and be sure
to test fixture BEFORE
trimming.**

19 Connect arm wires using plug-in connectors. See detailed illustration.

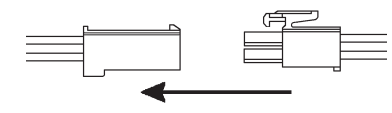

20 Push wires into hole and attach arm into place by tightening screws.

21 Install bobèche on every arm and screw bulbs into all sockets and test fixture before trimming. If any of the bulbs do NOT light - DISCONNECT POWER. Double check the wire connections.

22 Install scroll(s) into hole pattern in washer. Tighten screw to secure scroll(s) in place.

