

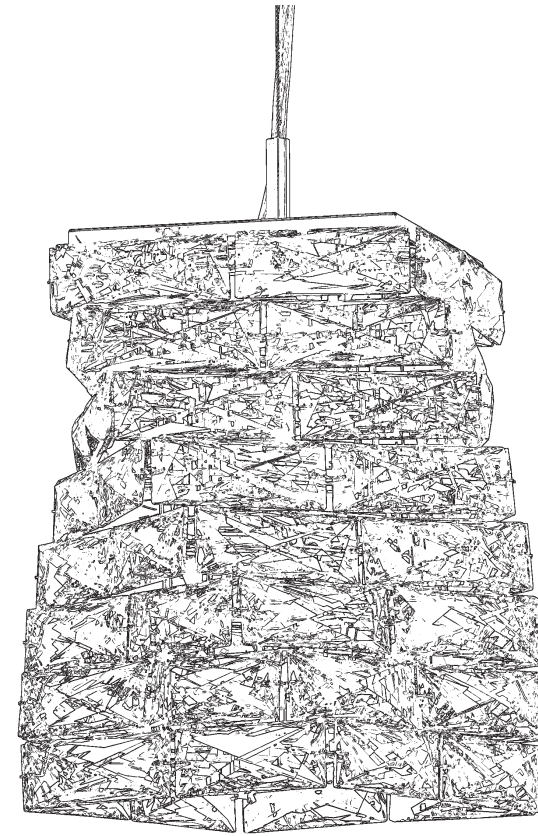











 **SCHONBEK** | 1870



**GLISSANDO  
STW510N-SS1S**



 **SCHONBEK** | 1870

							110-120 V	13 W
								

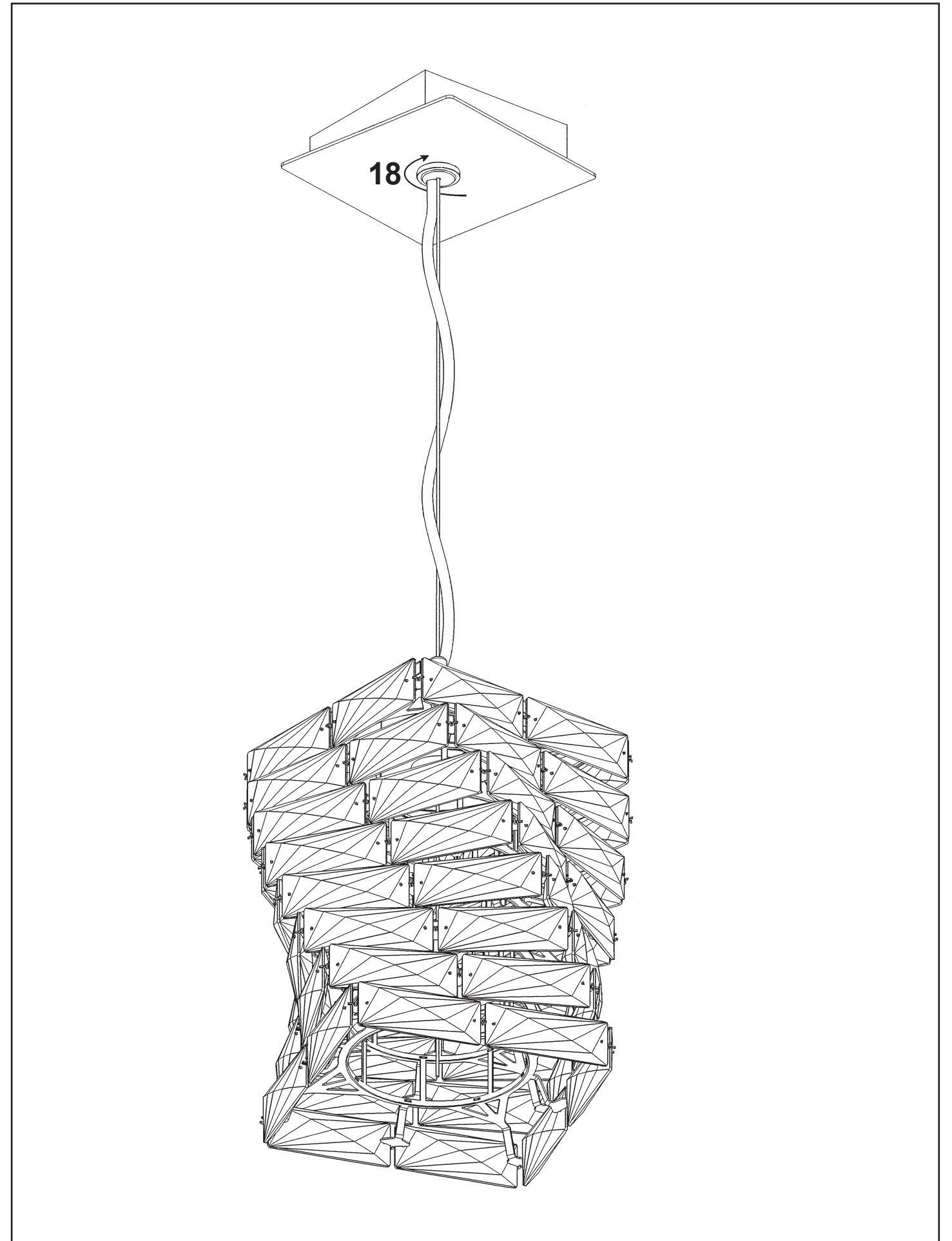
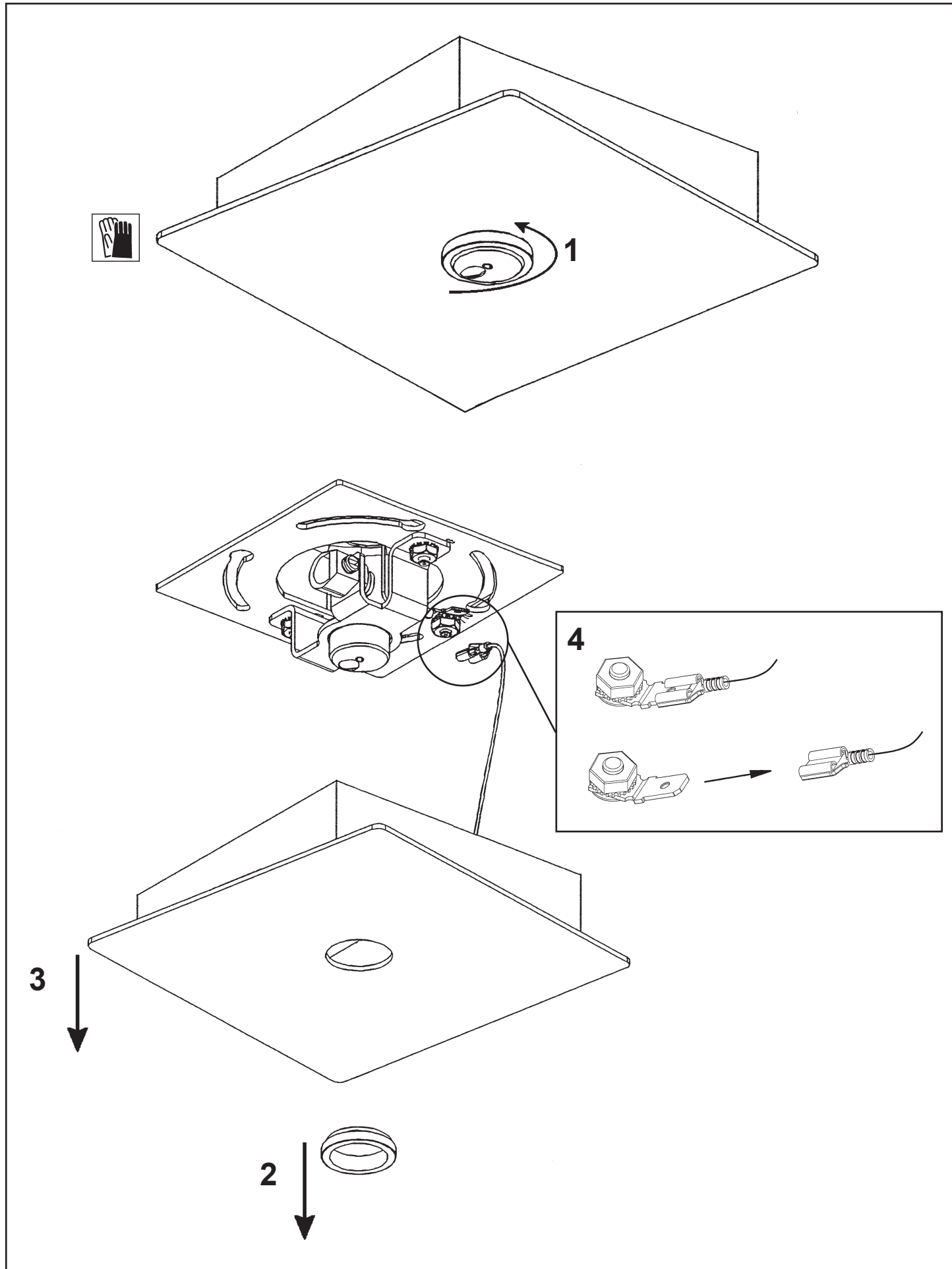

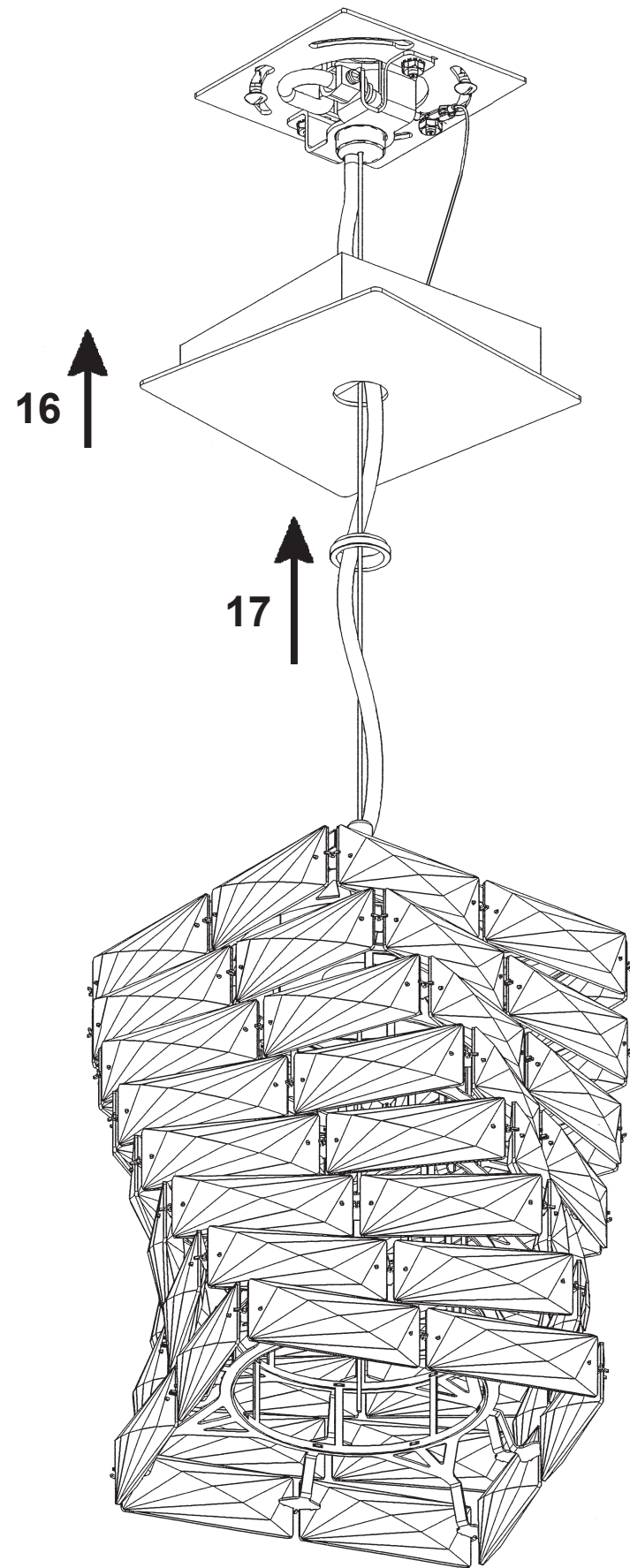

1 X  : 30561/12

