

# BELLA ROSE TC1036N-\_\_ \_\_H













10 Lights  
Diameter: 36"  
Height: 24"  
Hanging Weight: 29lbs.

**T**HIS DESIGN IS THE PROPRIETARY TRADE DRESS/TRADEMARK OF W SCHONBEK LLC.

 **SCHONBEK** | 1870

 **SCHONBEK** | 1870

								
MAX <u>60</u> W	110-120 V							

**WARNING:**

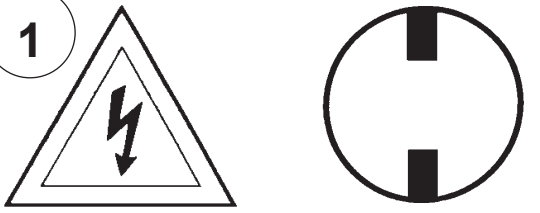
1 

**Electrical Danger Turn Power Off**

All electrical components must be installed by a licensed electrician in accordance with the National Electric Code and the appropriate local electrical codes.

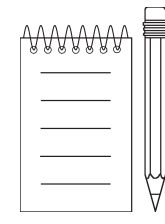
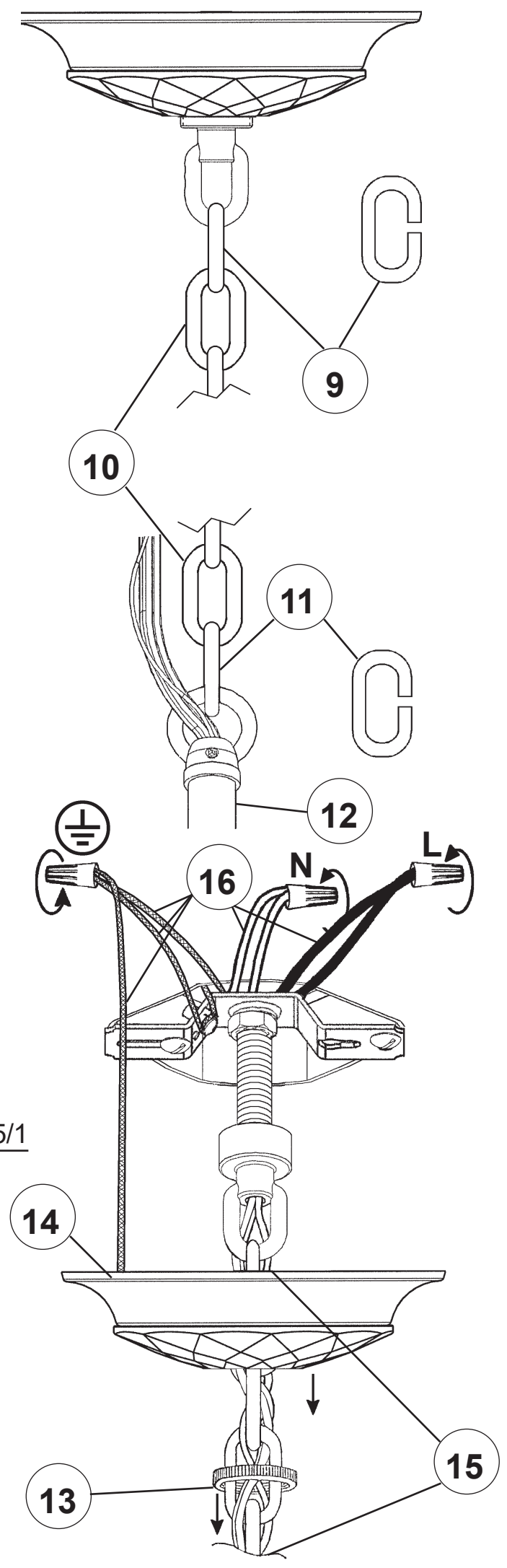
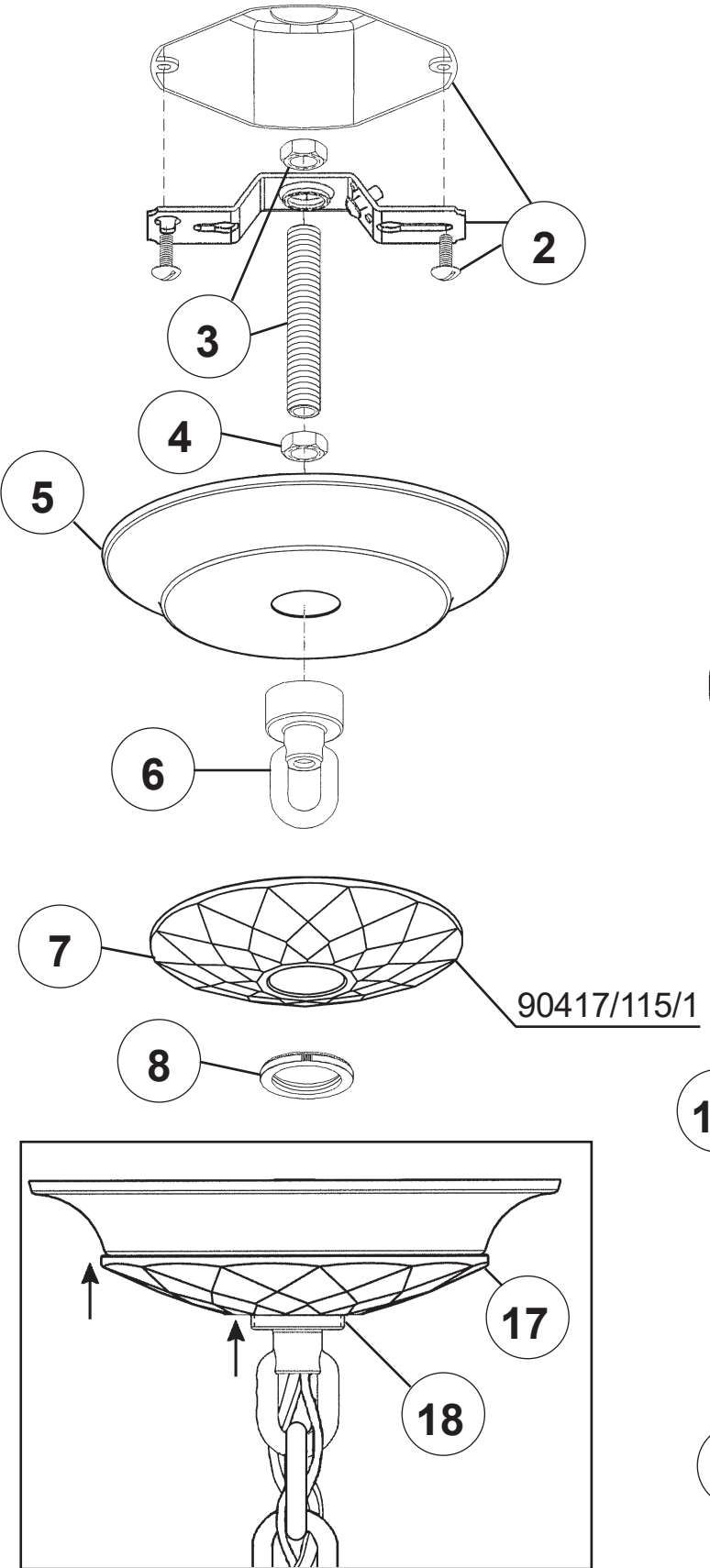

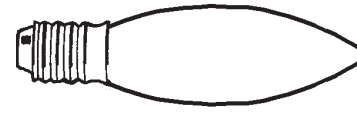

You will need 10 - B10  
60 Watts Max

**Install bulbs and be sure  
to test fixture BEFORE  
trimming.**

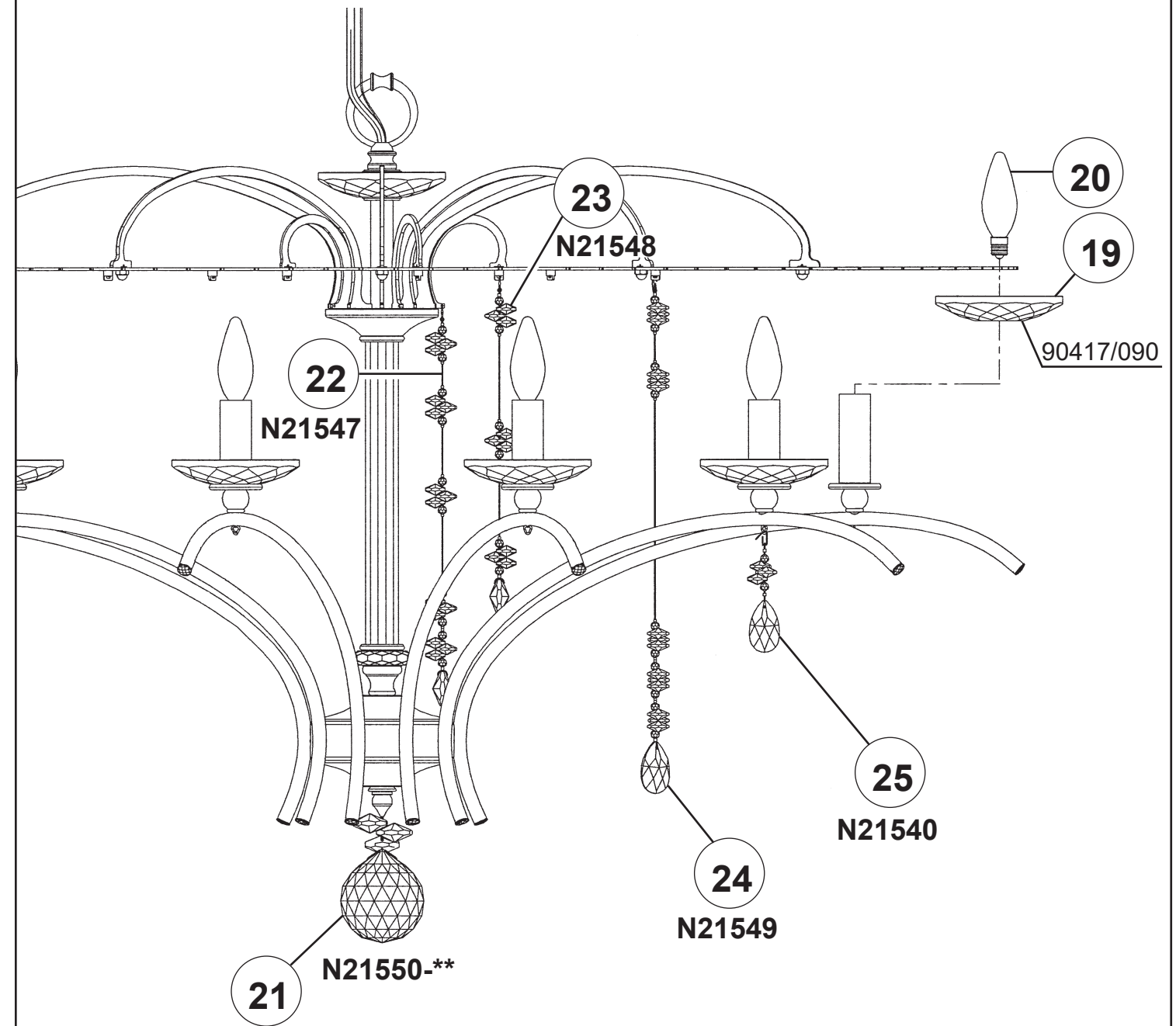



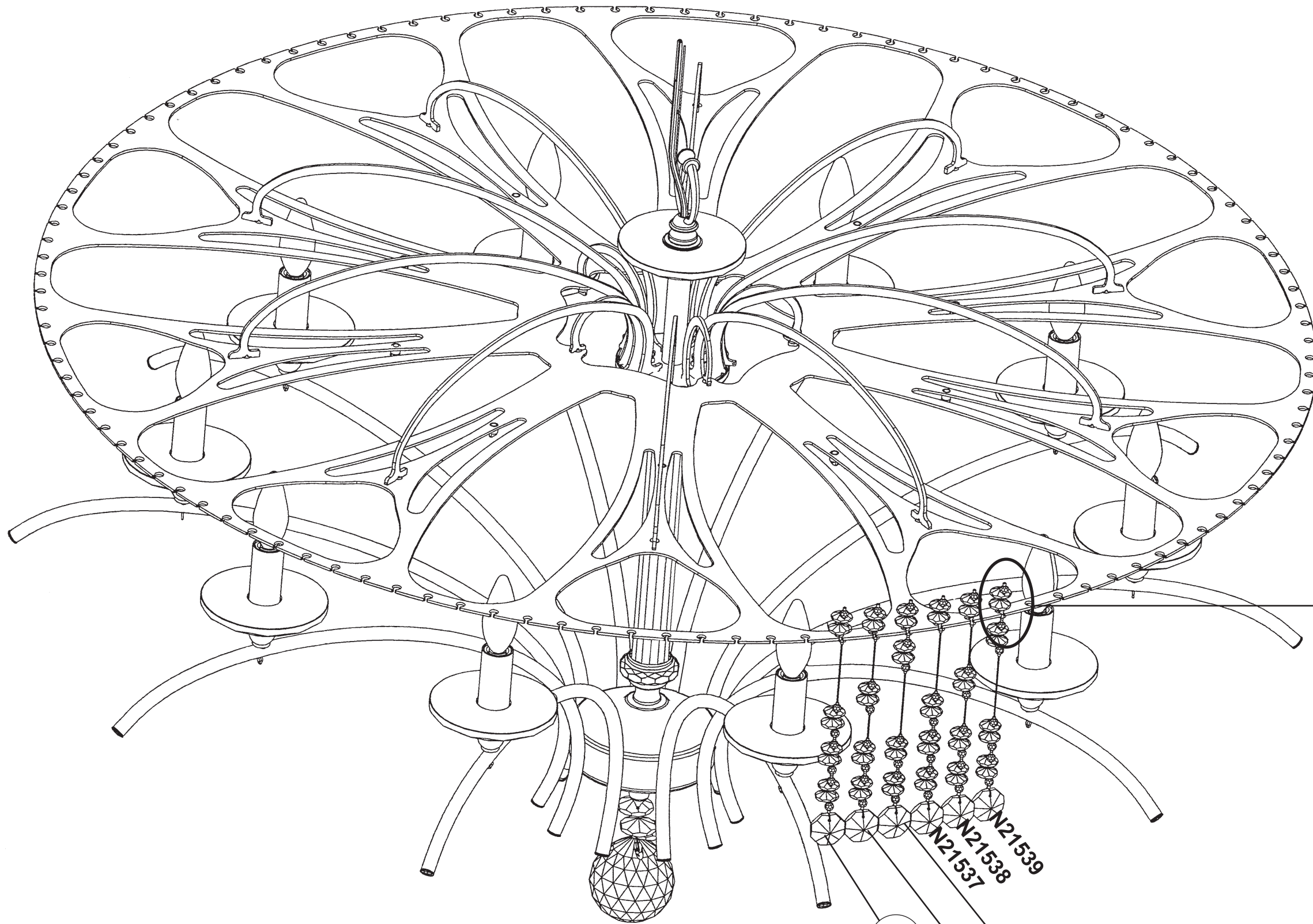

26  
N21537

27  
N21538

28  
N21539

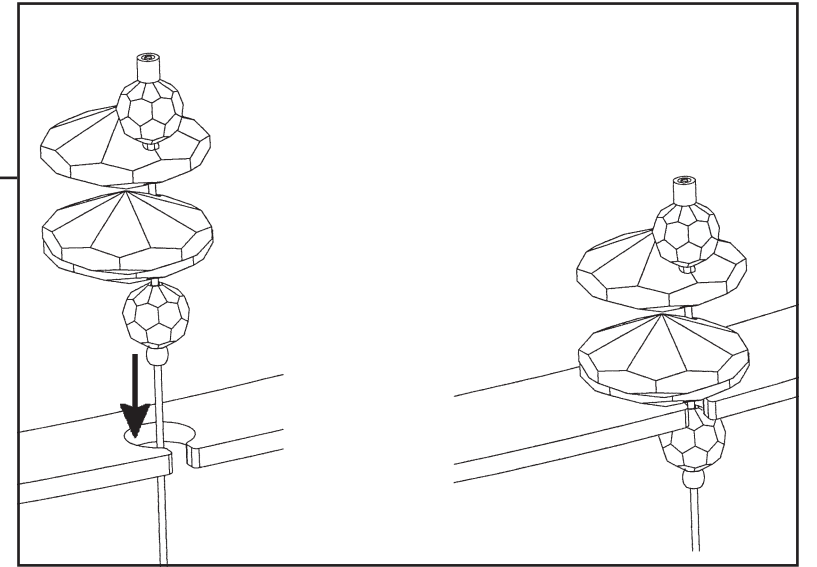

# BELLA ROSE TC1036N-\_\_ \_\_R













10 Lights  
Diameter: 36"  
Height: 24"  
Hanging Weight: 29lbs.

**T**HIS DESIGN IS THE PROPRIETARY  
TRADE DRESS/TRADEMARK OF  
W SCHONBEK LLC.

 **SCHONBEK** | 1870

 **SCHONBEK** | 1870

								
MAX 60 W	110-120 V							

**WARNING:**

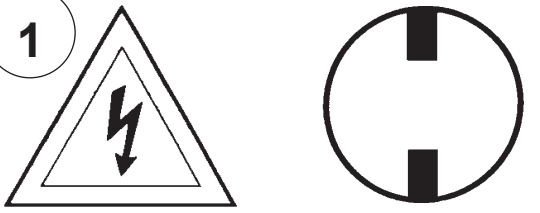
1 

**Electrical Danger Turn Power Off**

All electrical components must be installed by a licensed electrician in accordance with the National Electric Code and the appropriate local electrical codes.

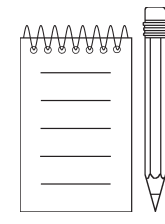
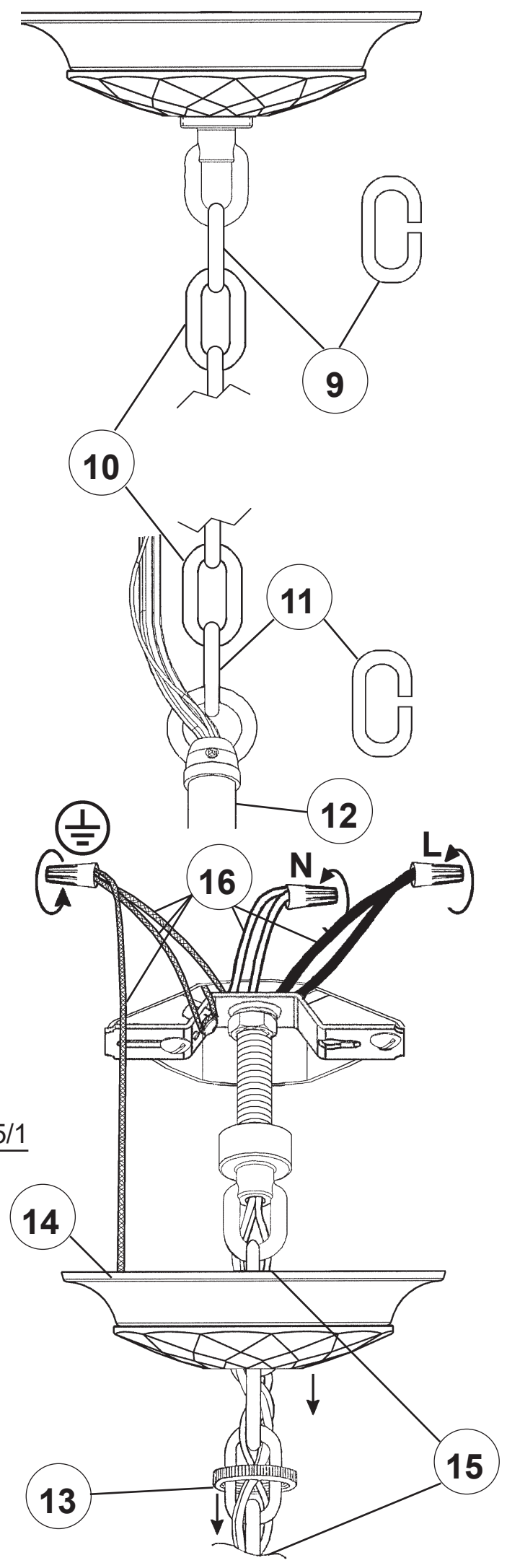
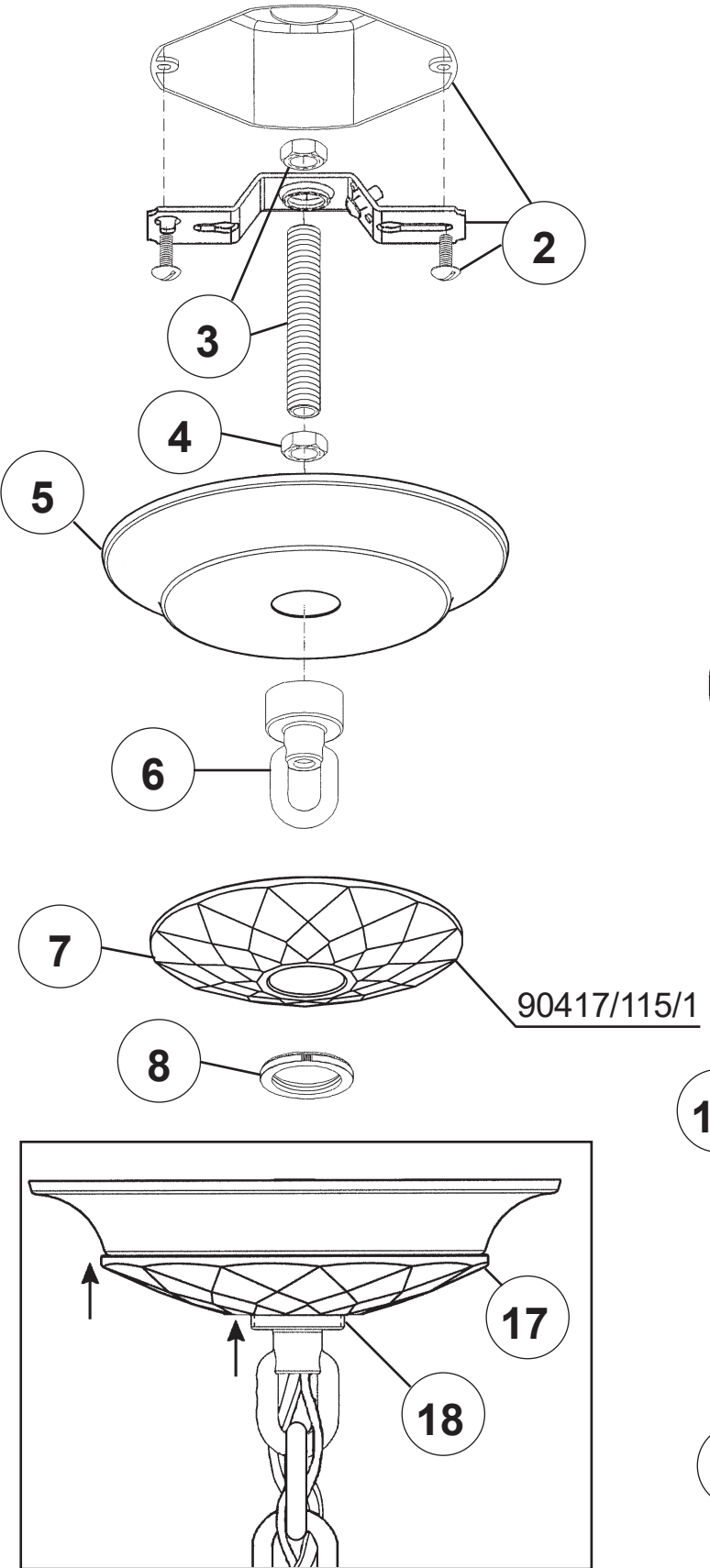



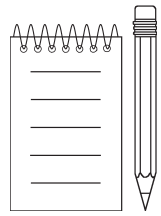

You will need 10 - B10  
60 Watts Max

**Install bulbs and be sure  
to test fixture BEFORE  
trimming.**

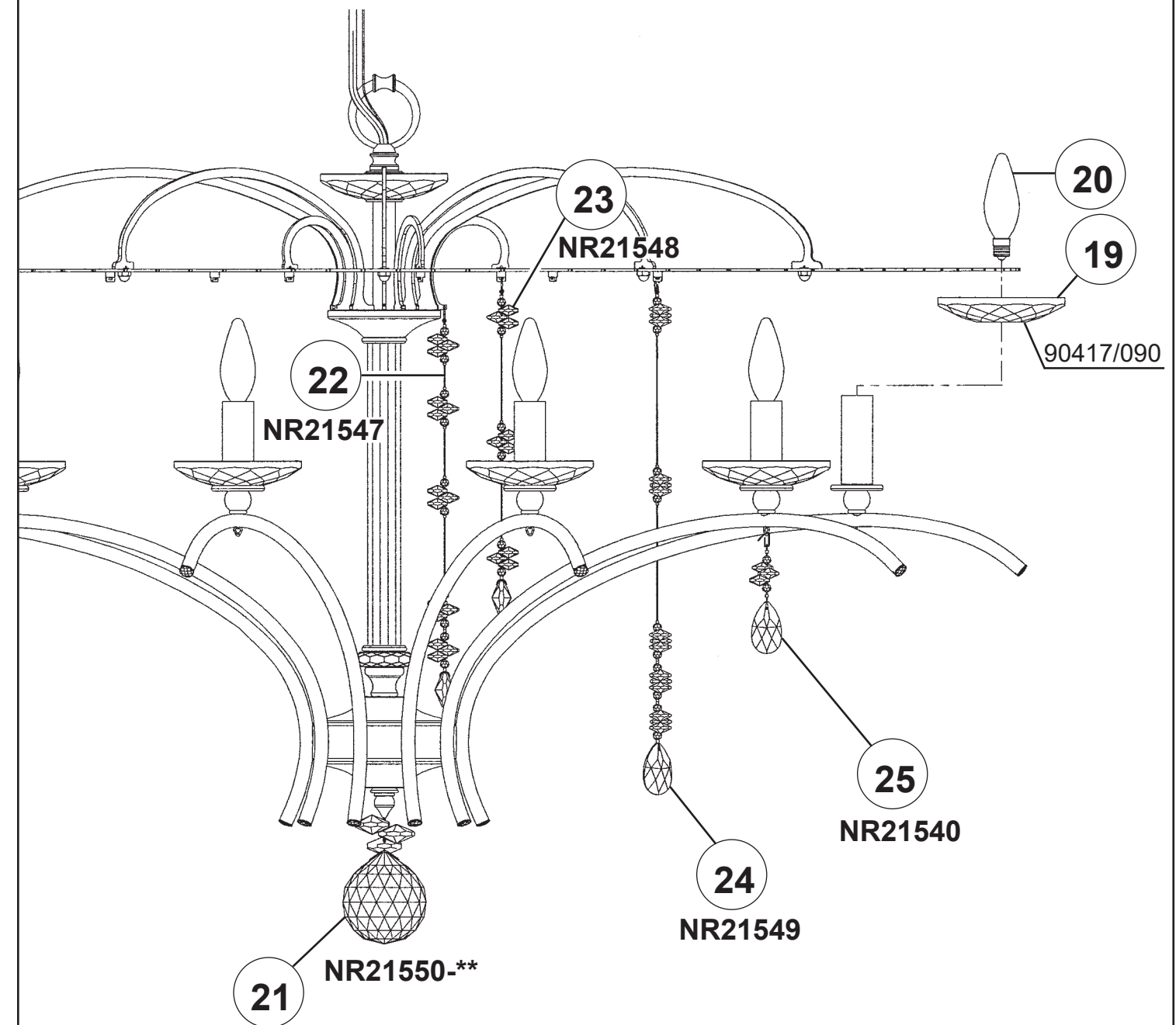

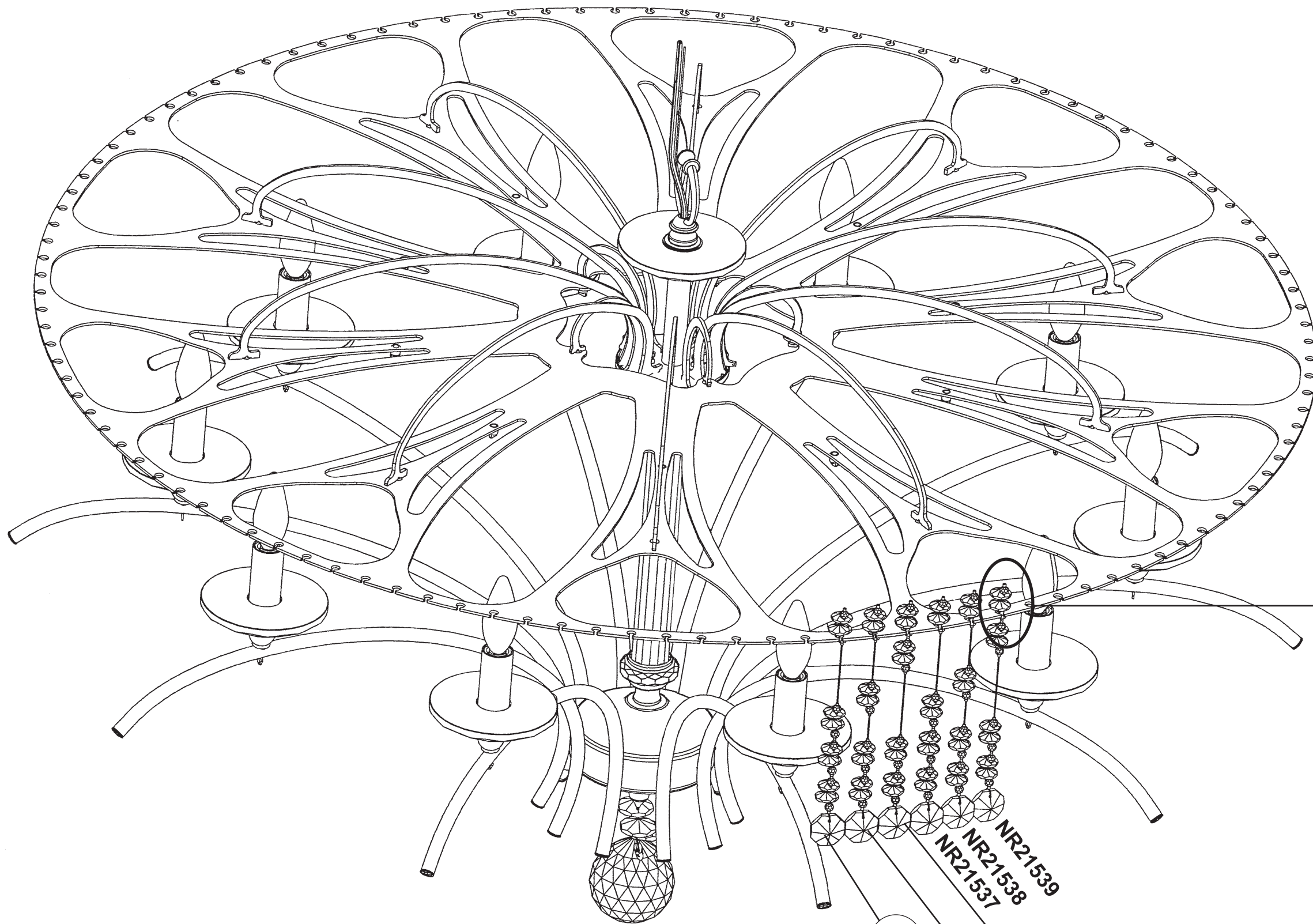

NR21537 26  
NR21538 27  
NR21539 28

