

 **SCHONBEK** | 1870

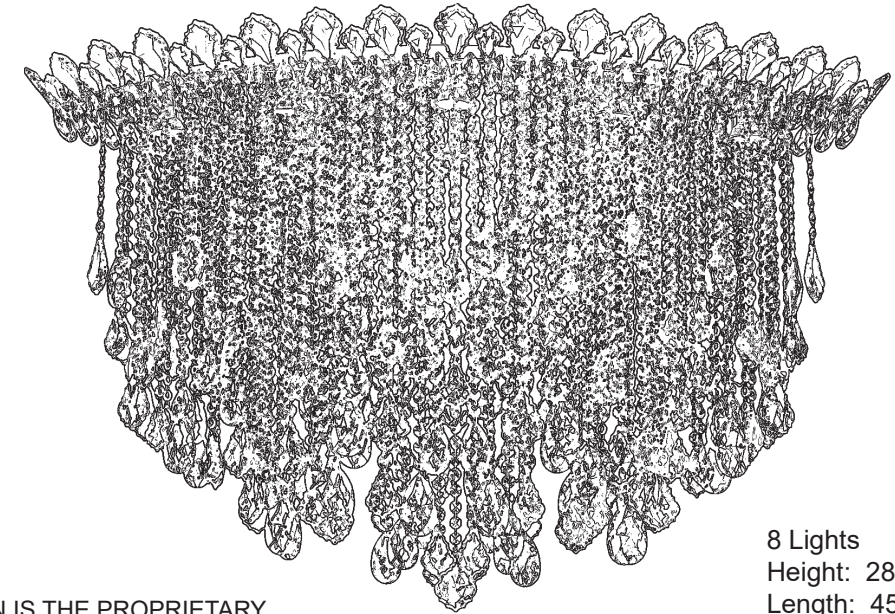







TRILLIANE STRANDS
TR4802N- __ _ H



THIS DESIGN IS THE PROPRIETARY
TRADE DRESS/TRADEMARK OF
W SCHONBEK LLC.

8 Lights
Height: 28-1/2"
Length: 45"
Width: 25"
Hanging Weight: 62lbs.

 **SCHONBEK** | 1870

			S					
MAX 35 W	110-120 V							

NOTE: INSTALLER IS SOLELY RESPONSIBLE FOR PROPER MOUNTING!

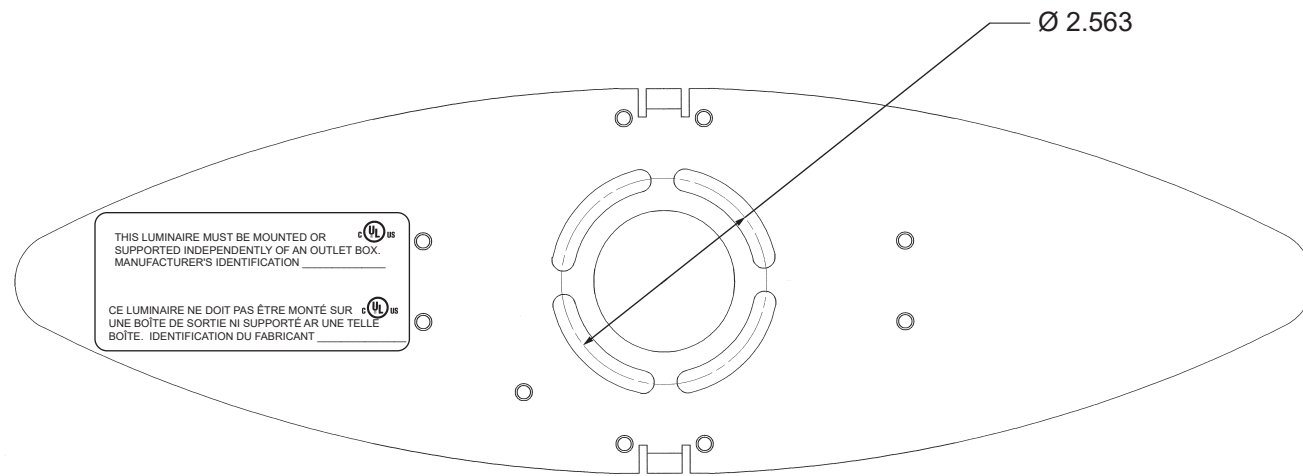

PLAN VIEW OF MOUNTING BRACKET

CROSS MEMBERS SECURELY FASTENS TO JOIST OR SIMILAR STRUCTURE MEMBER

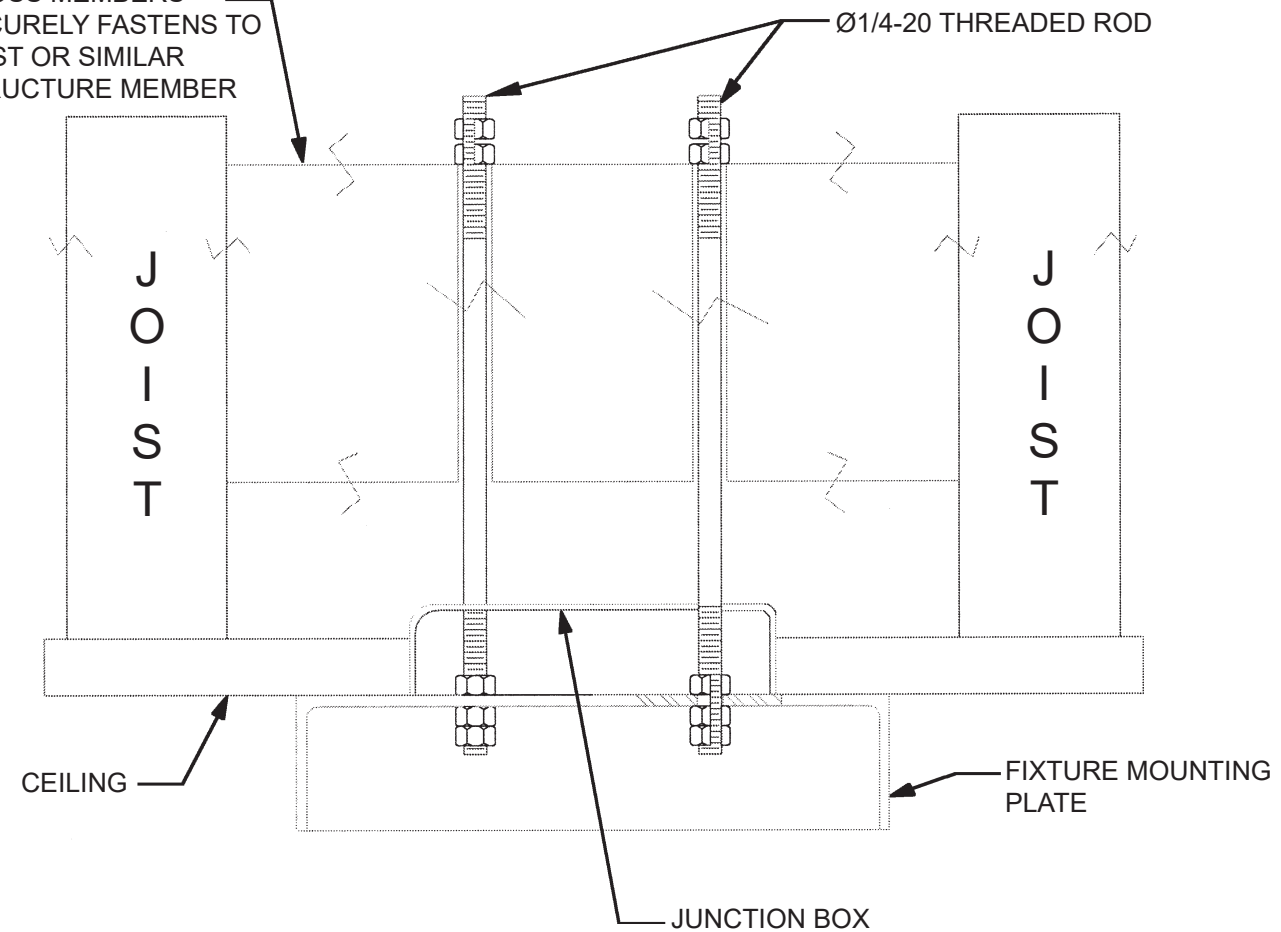

WARNING:

MOUNTING CONFIGURATION AND HARDWARE MUST HOLD 4X THE WEIGHT OF THE FIXTURE. MOUNTING DESIGN AND FIXTURE INSTALLATION SHOULD BE CONDUCTED BY A QUALIFIED LICENSED PROFESSIONAL.

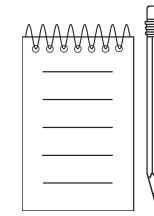

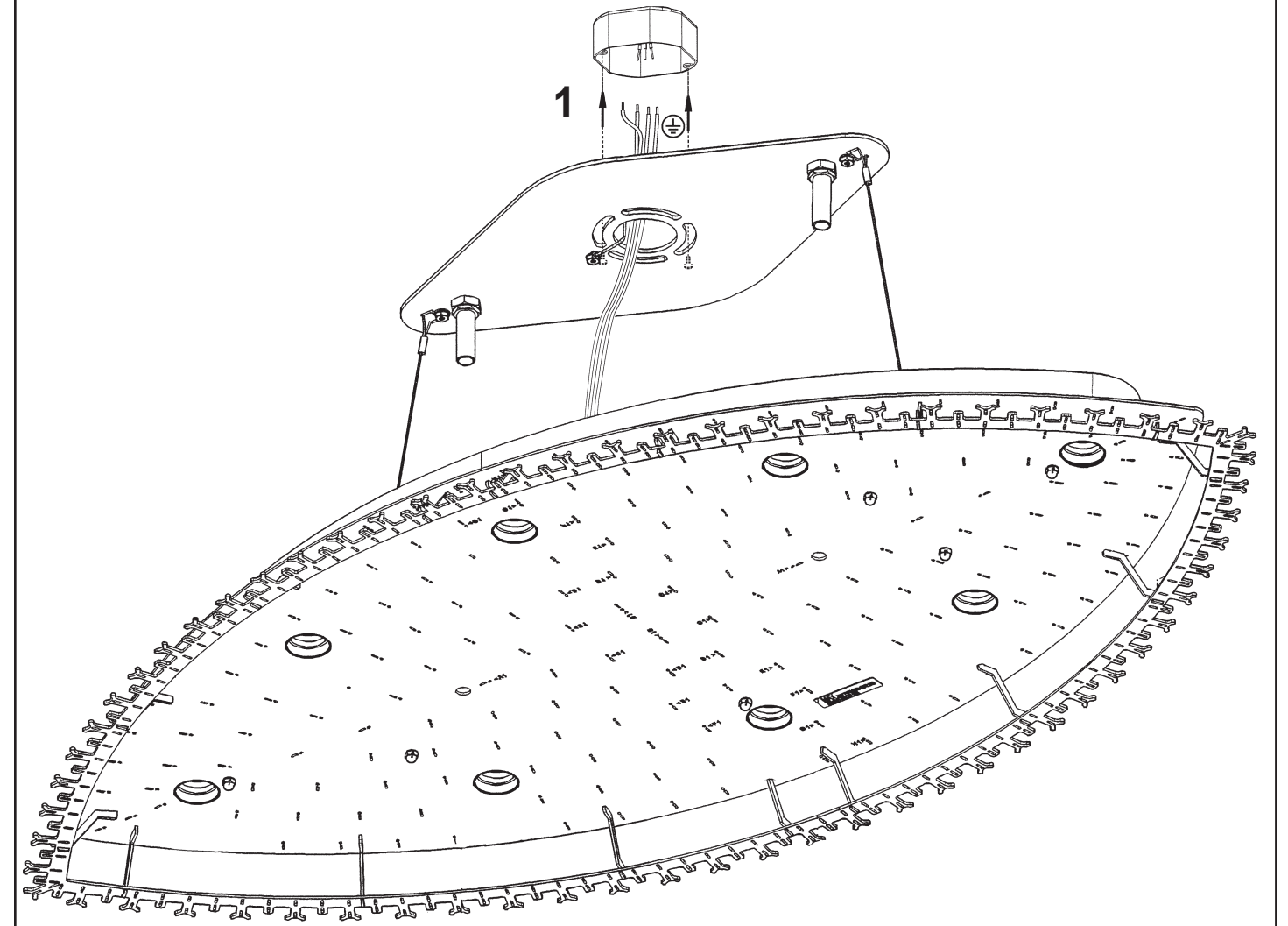
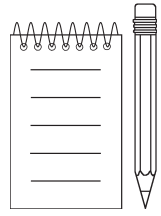

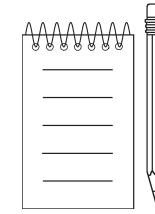
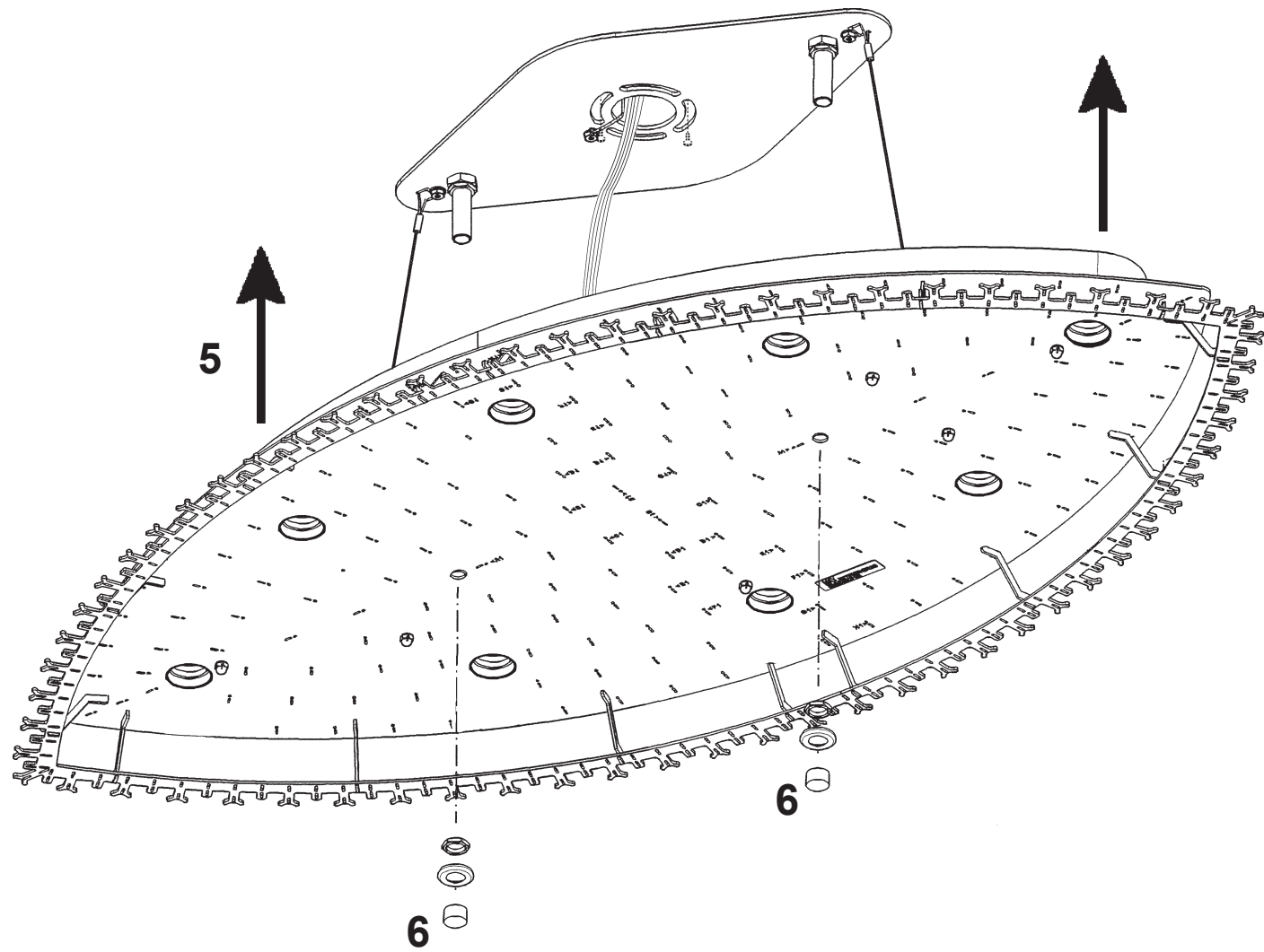
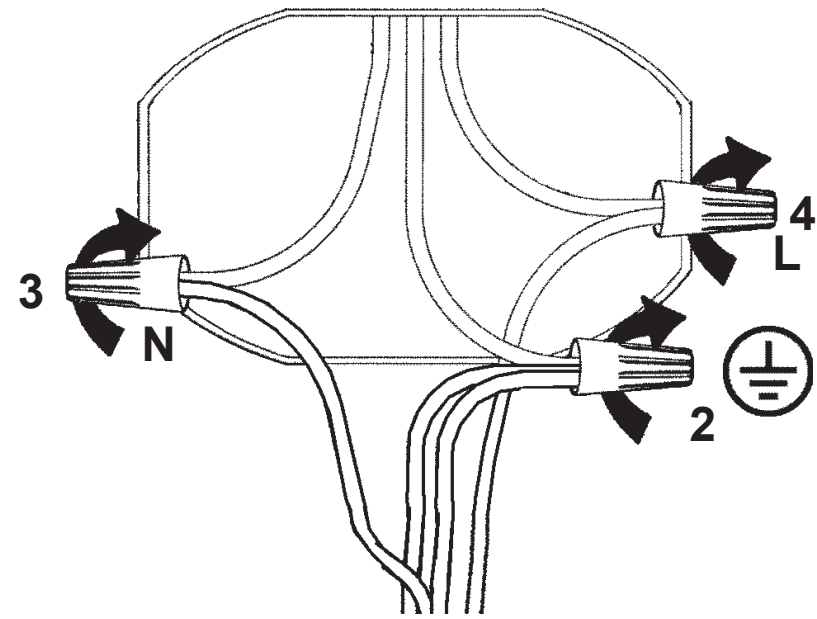

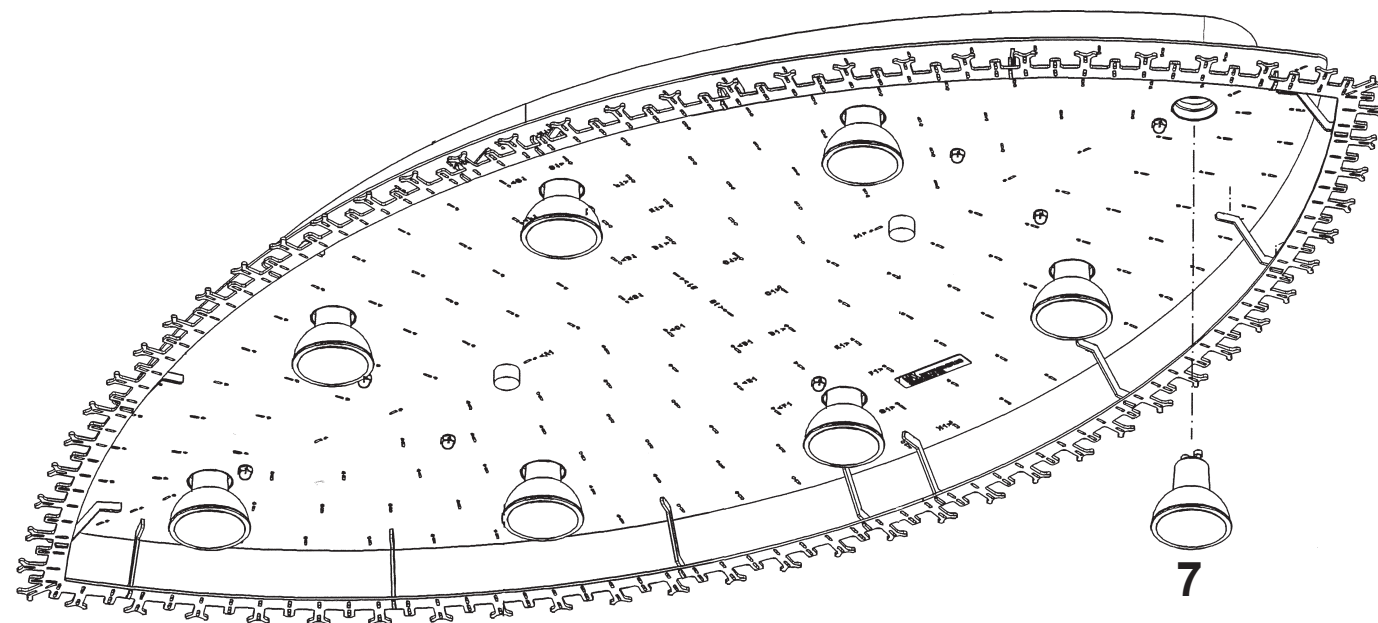
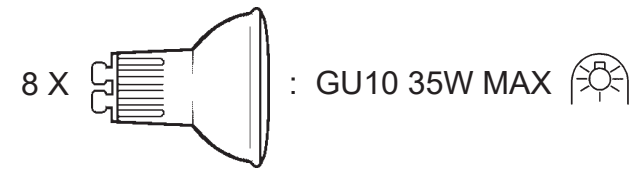
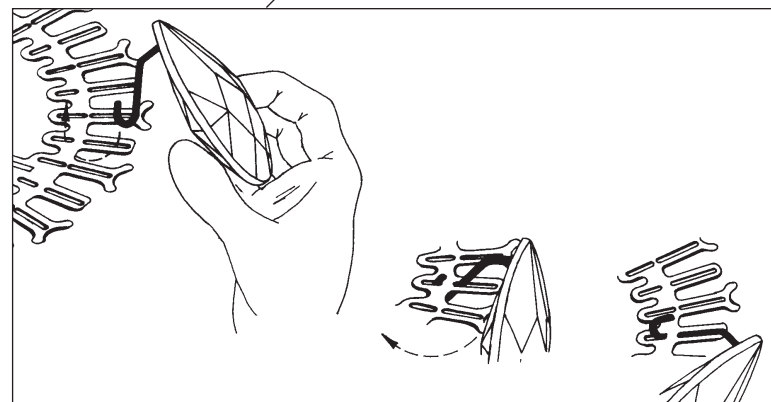
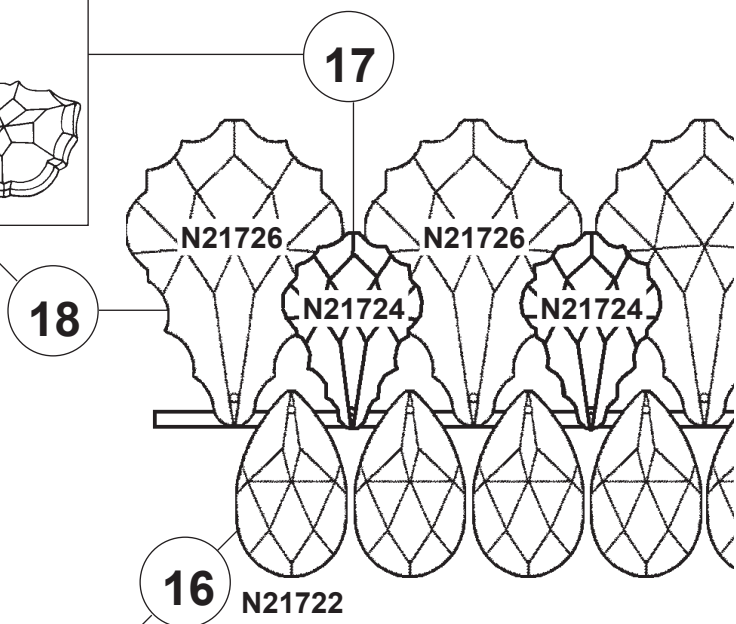
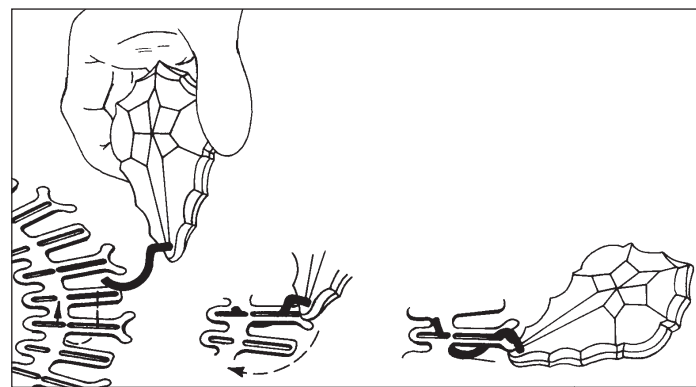
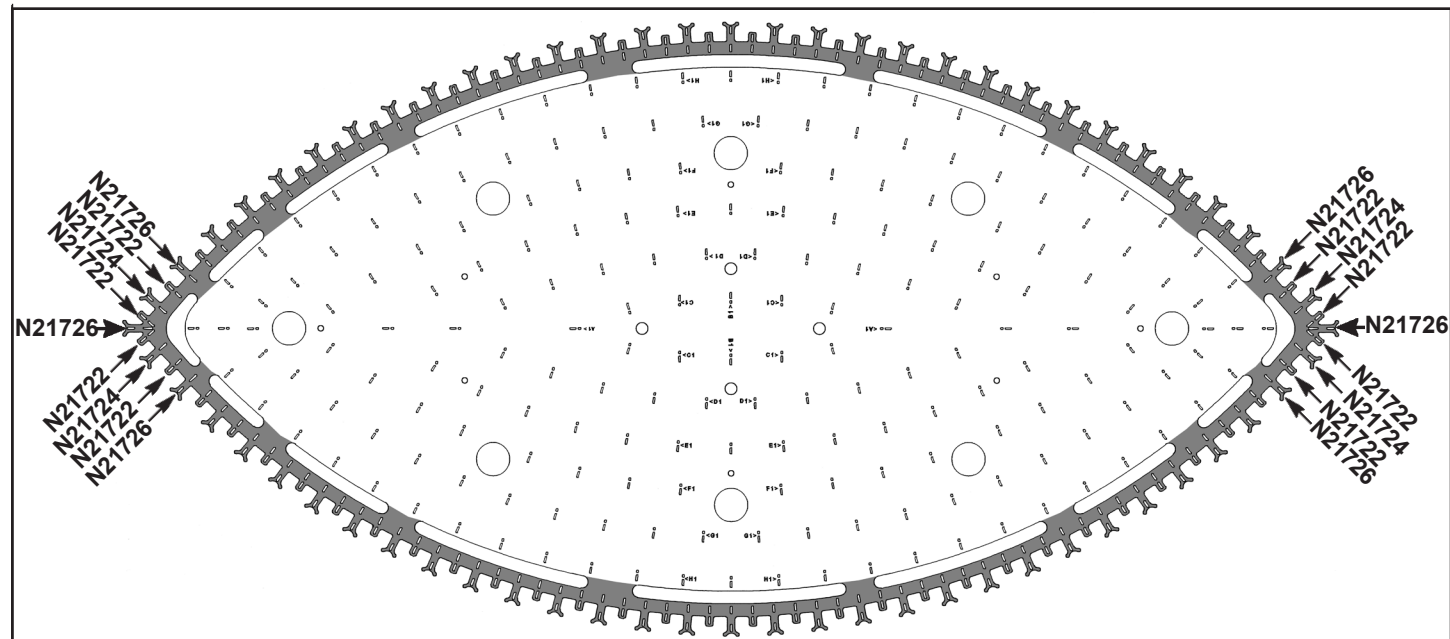

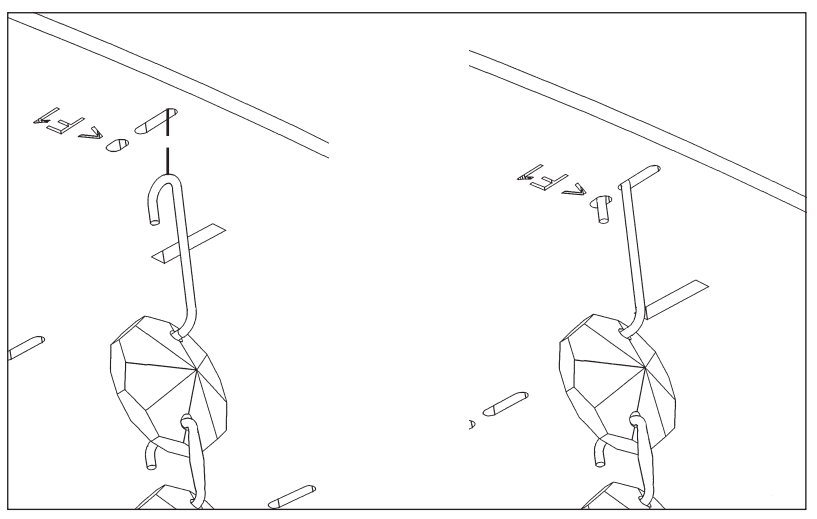
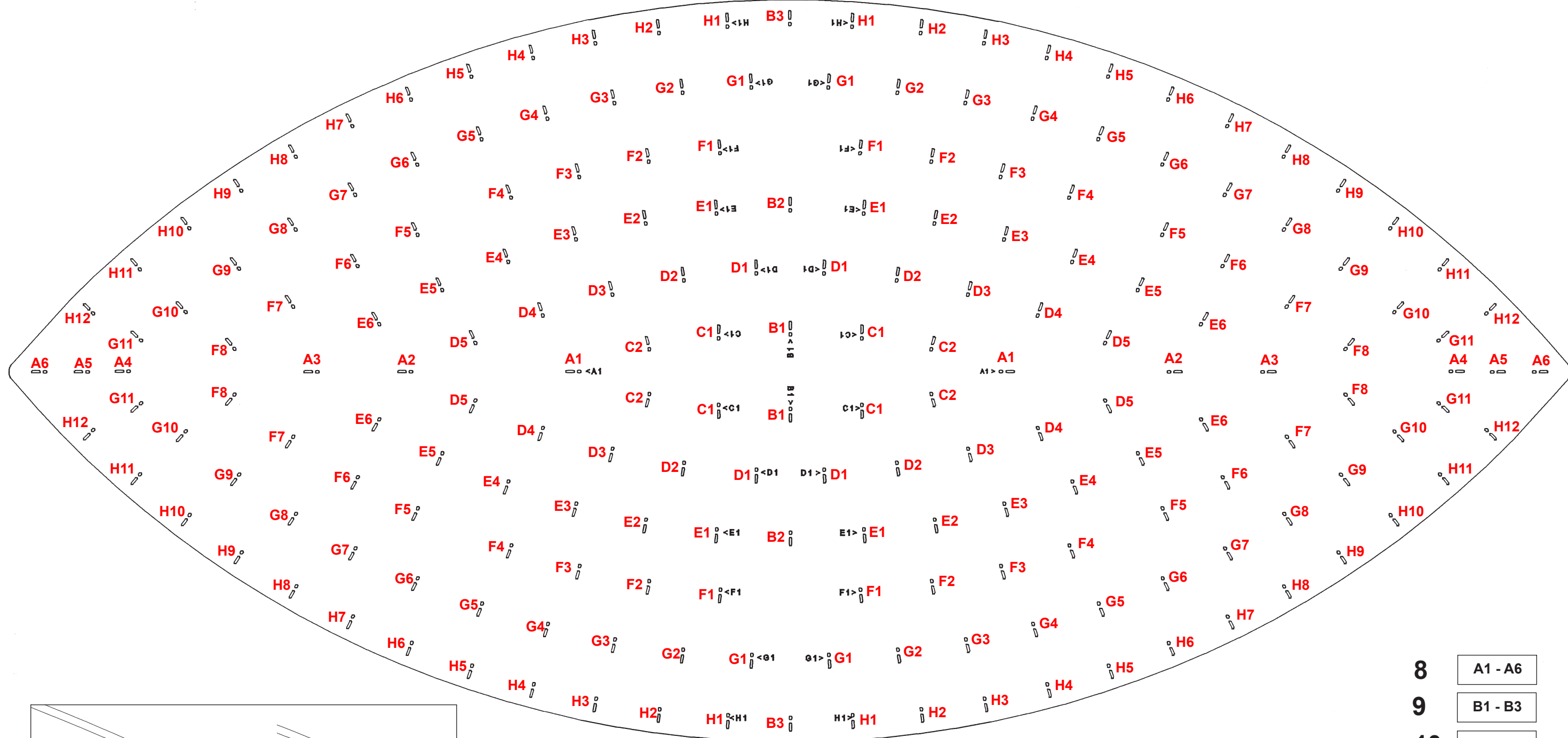

After hanging all trim, remove labels from crystals. If residue remains, wipe off crystal with a soft, dry cloth.

- 8 A1 - A6
- 9 B1 - B3
- 10 C1 - C2
- 11 D1 - D5
- 12 E1 - E6
- 13 F1 - F8
- 14 G1 - G11
- 15 H1 - H12

 **SCHONBEK** | 1870



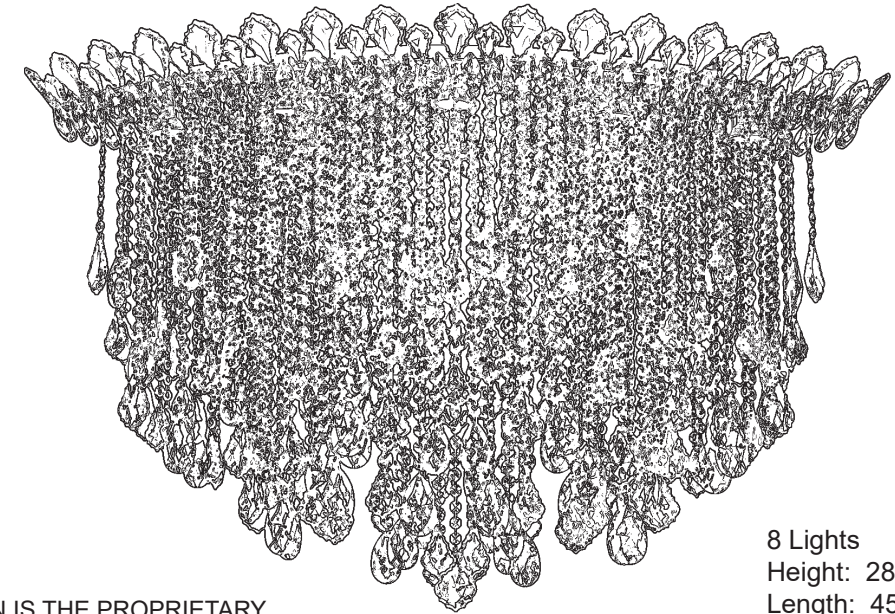





TRILLIANE STRANDS TR4802N- __ _ R



THIS DESIGN IS THE PROPRIETARY
TRADE DRESS/TRADemark OF
W SCHONBEK LLC.

8 Lights
Height: 28-1/2"
Length: 45"
Width: 25"
Hanging Weight: 62lbs.

 **SCHONBEK** | 1870

			S					
MAX 35 W	110-120 V							

NOTE: INSTALLER IS SOLELY RESPONSIBLE FOR PROPER MOUNTING!

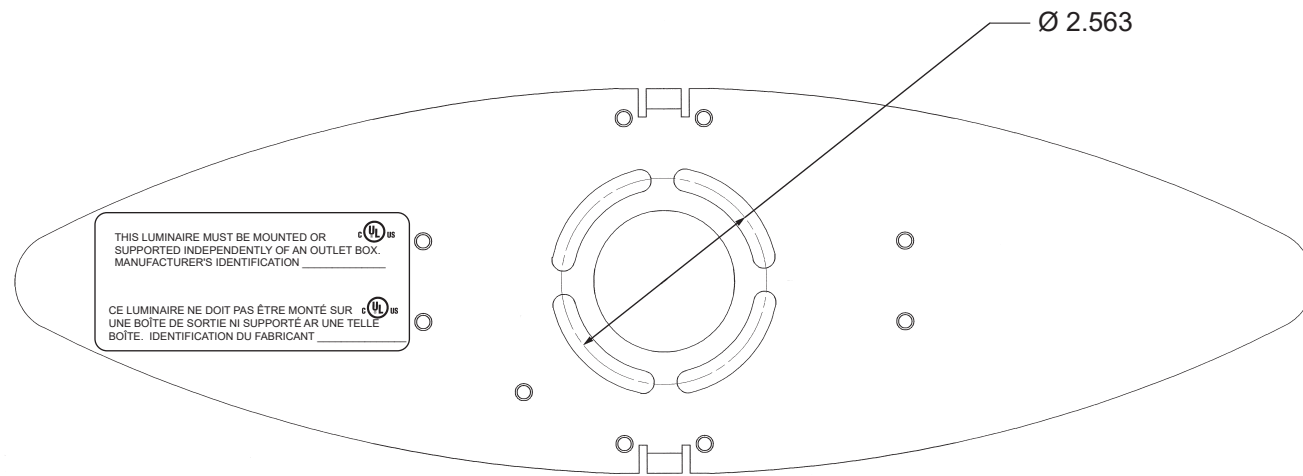

PLAN VIEW OF MOUNTING BRACKET

CROSS MEMBERS SECURELY FASTENS TO JOIST OR SIMILAR STRUCTURE MEMBER

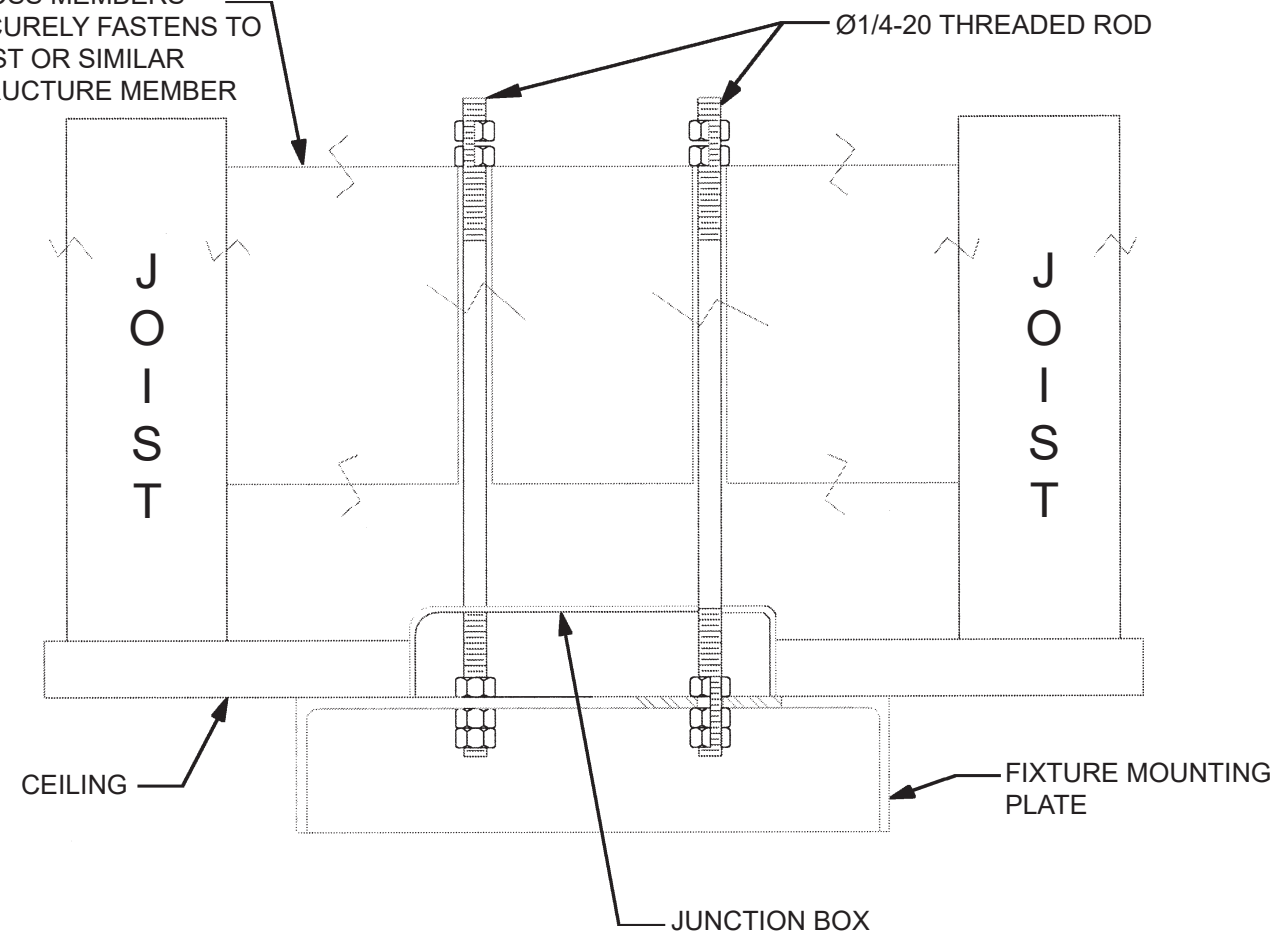

WARNING:

MOUNTING CONFIGURATION AND HARDWARE MUST HOLD 4X THE WEIGHT OF THE FIXTURE. MOUNTING DESIGN AND FIXTURE INSTALLATION SHOULD BE CONDUCTED BY A QUALIFIED LICENSED PROFESSIONAL.

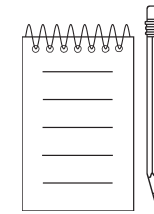

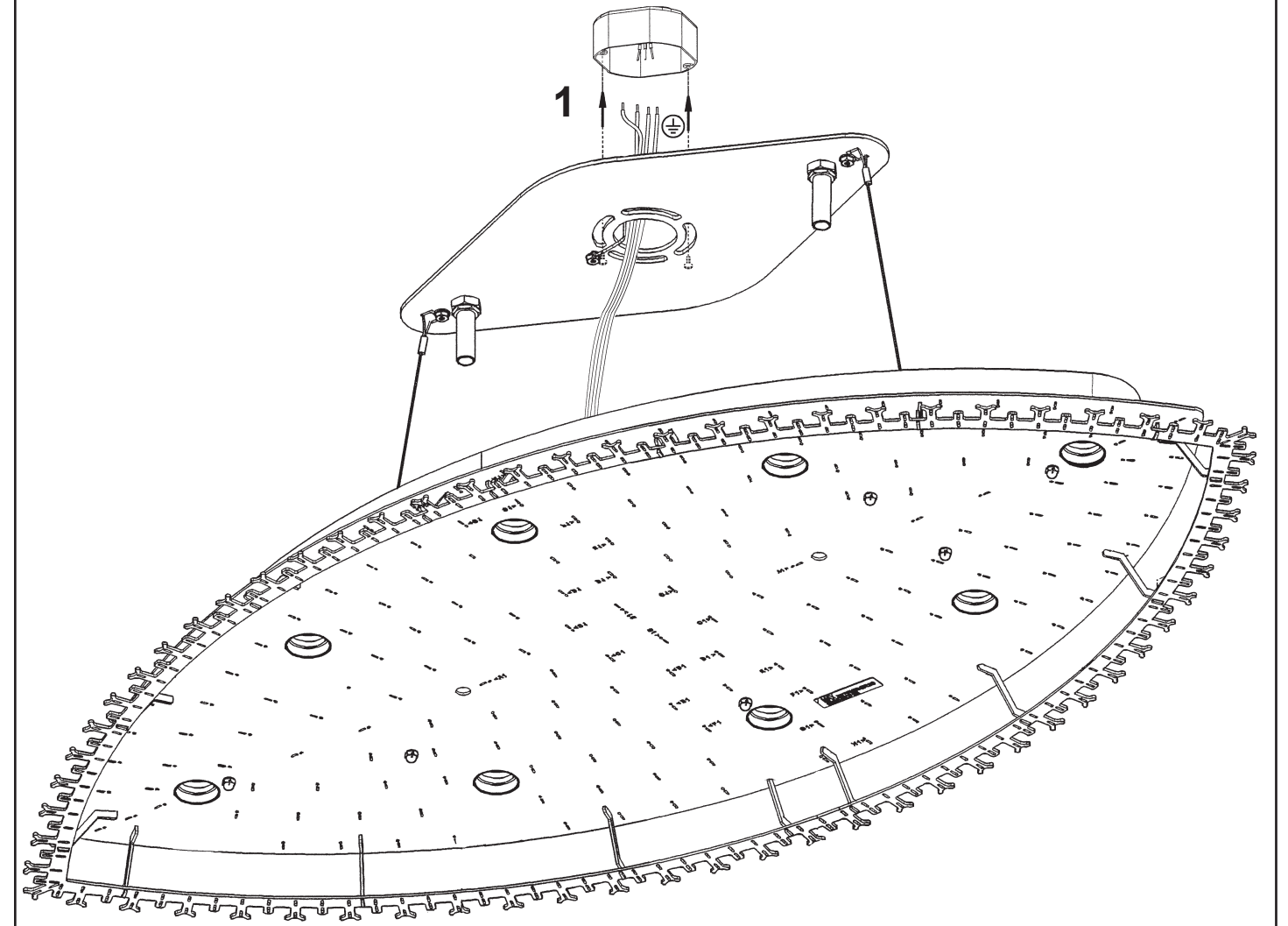
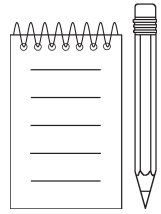

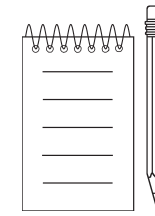
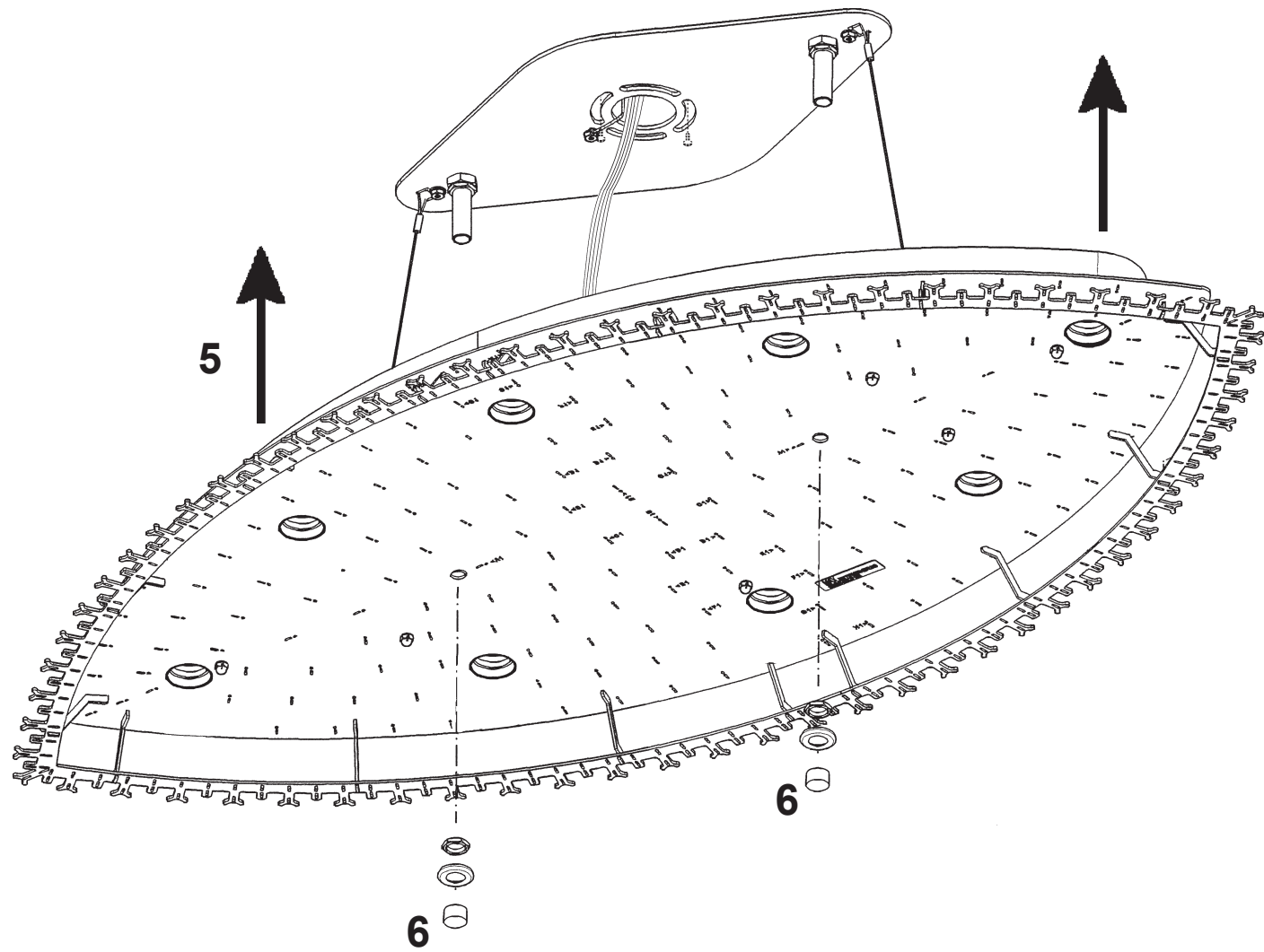
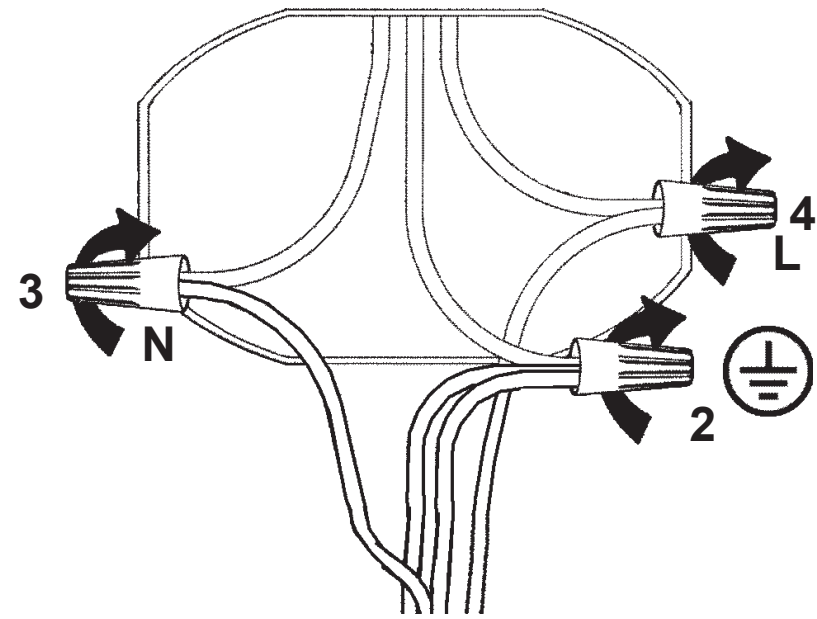

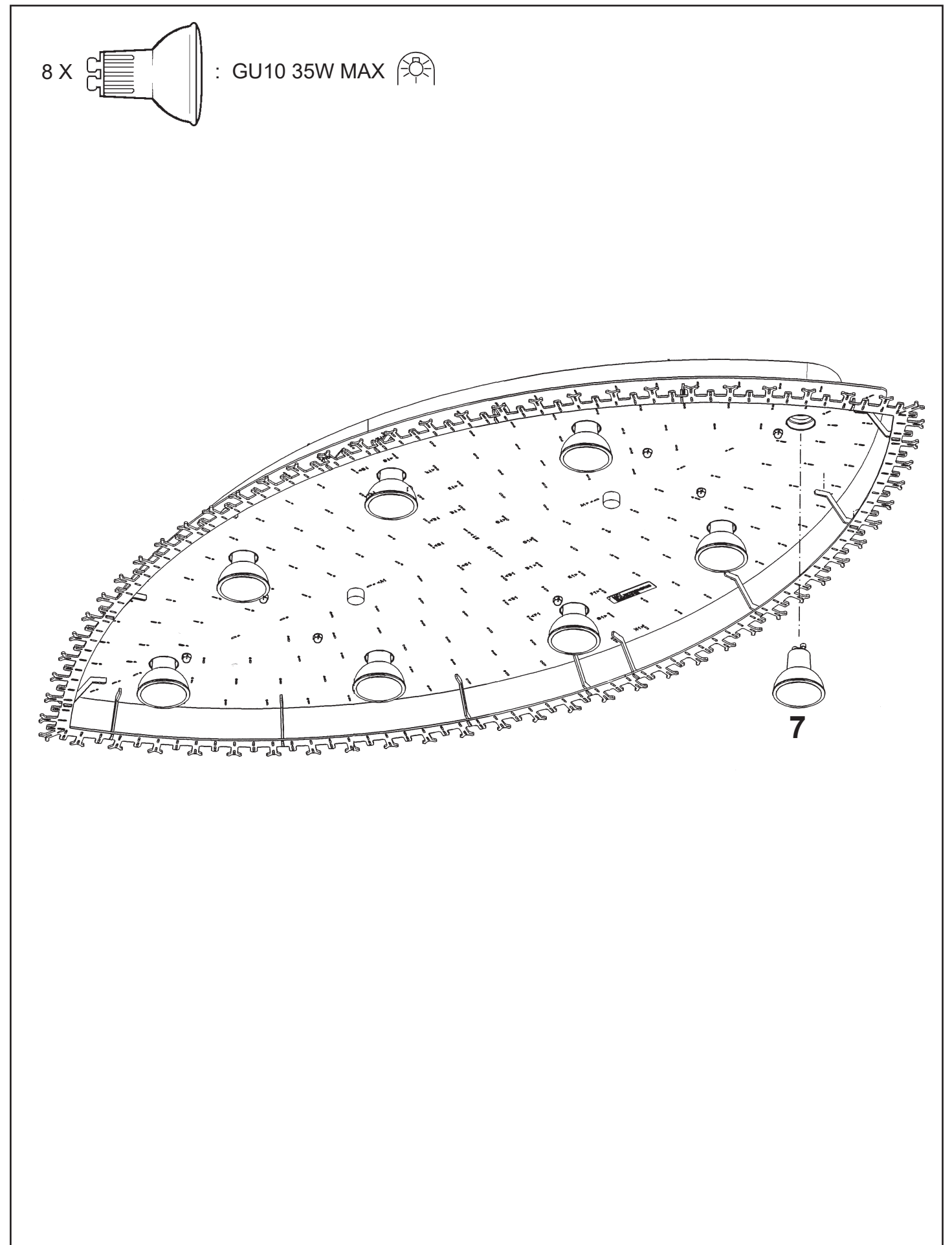
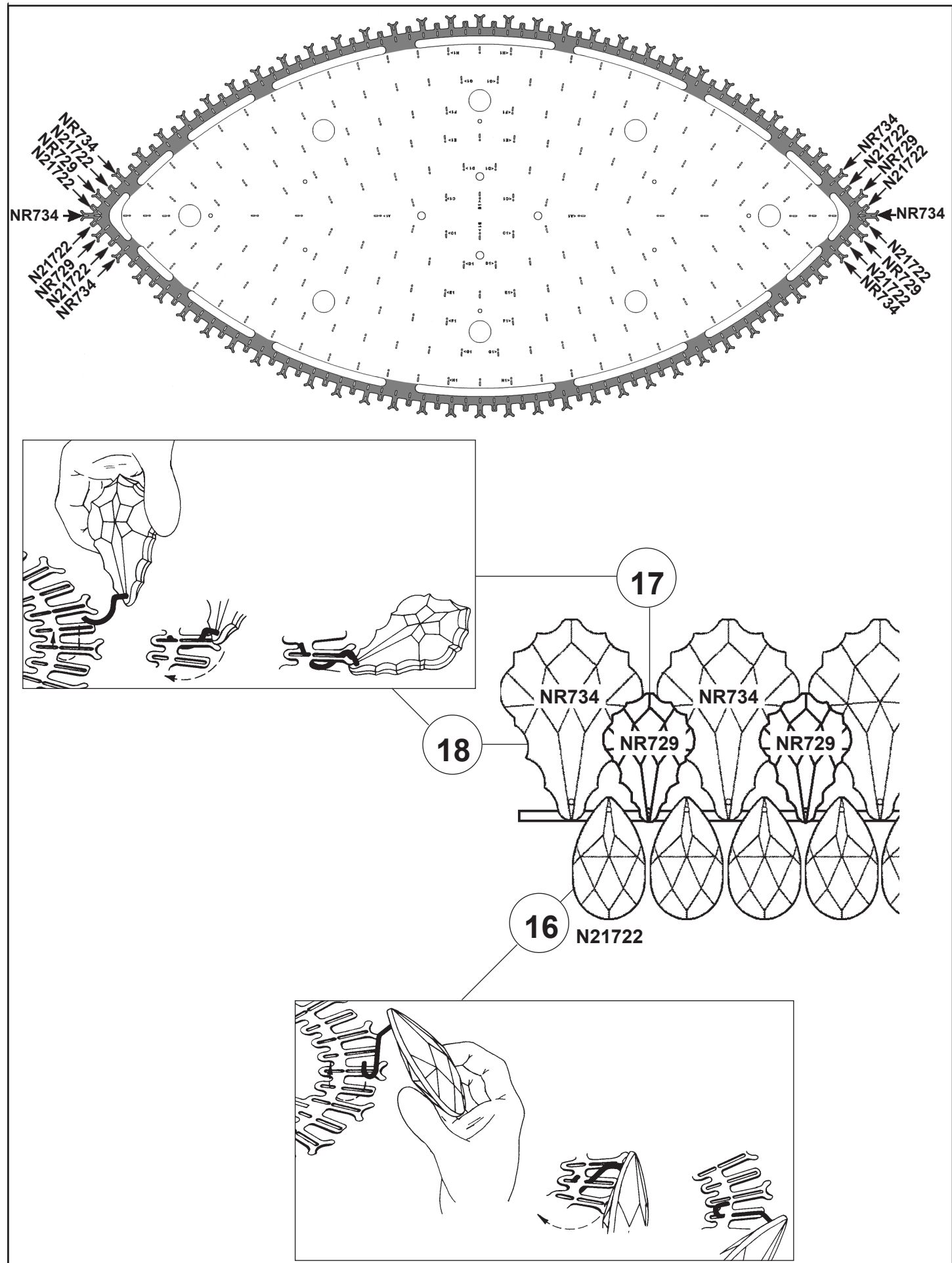

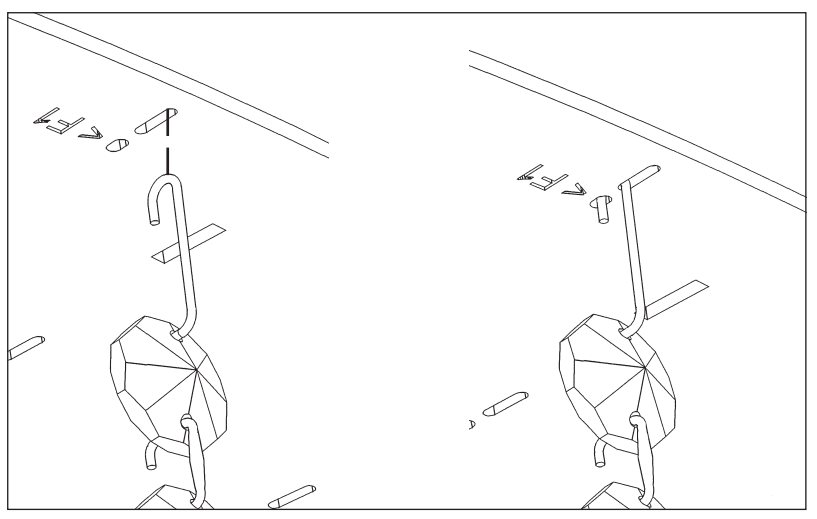
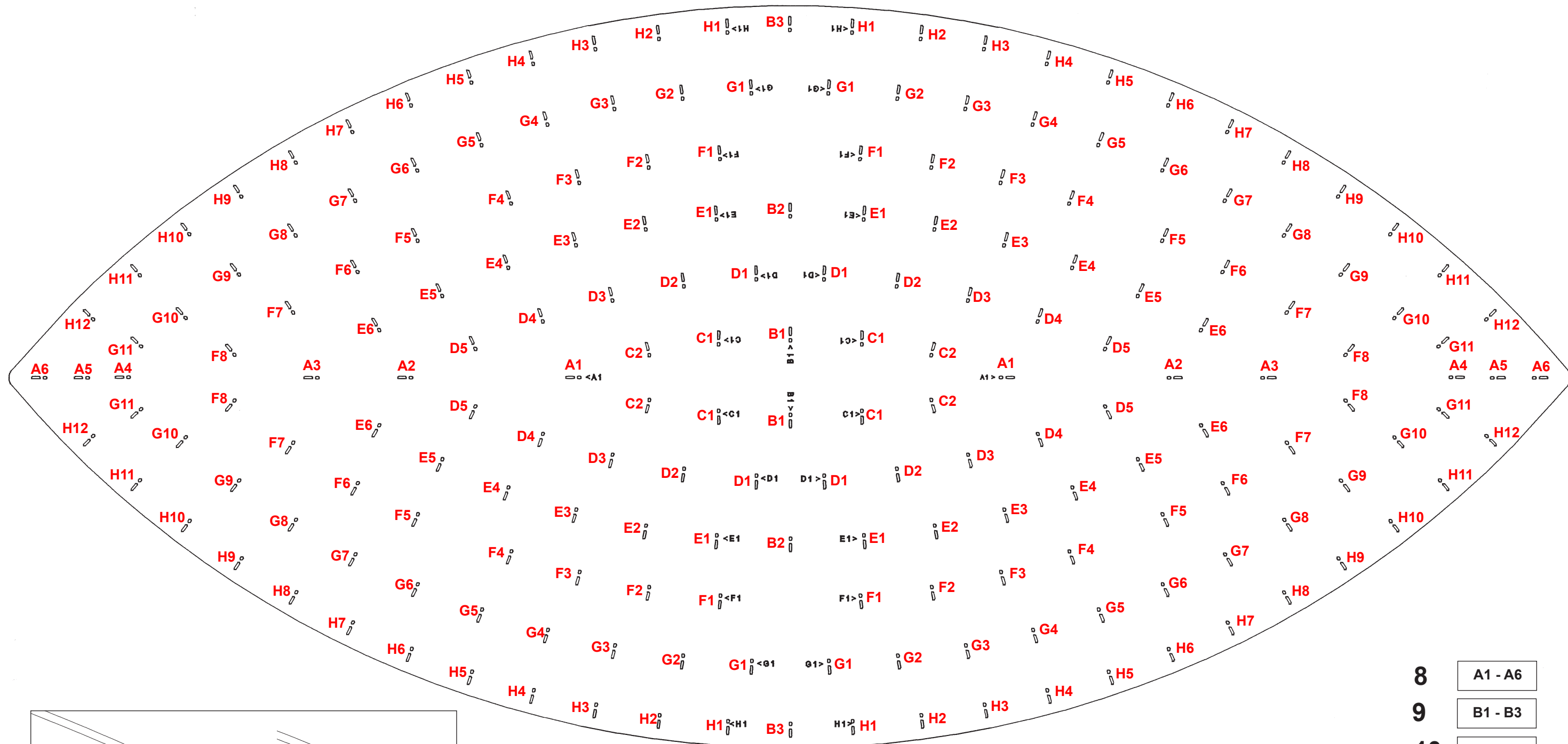

After hanging all trim, remove labels from crystals. If residue remains, wipe off crystal with a soft, dry cloth.

- 8 A1 - A6
- 9 B1 - B3
- 10 C1 - C2
- 11 D1 - D5
- 12 E1 - E6
- 13 F1 - F8
- 14 G1 - G11
- 15 H1 - H12