

VESCA VA8306N- __ __ H

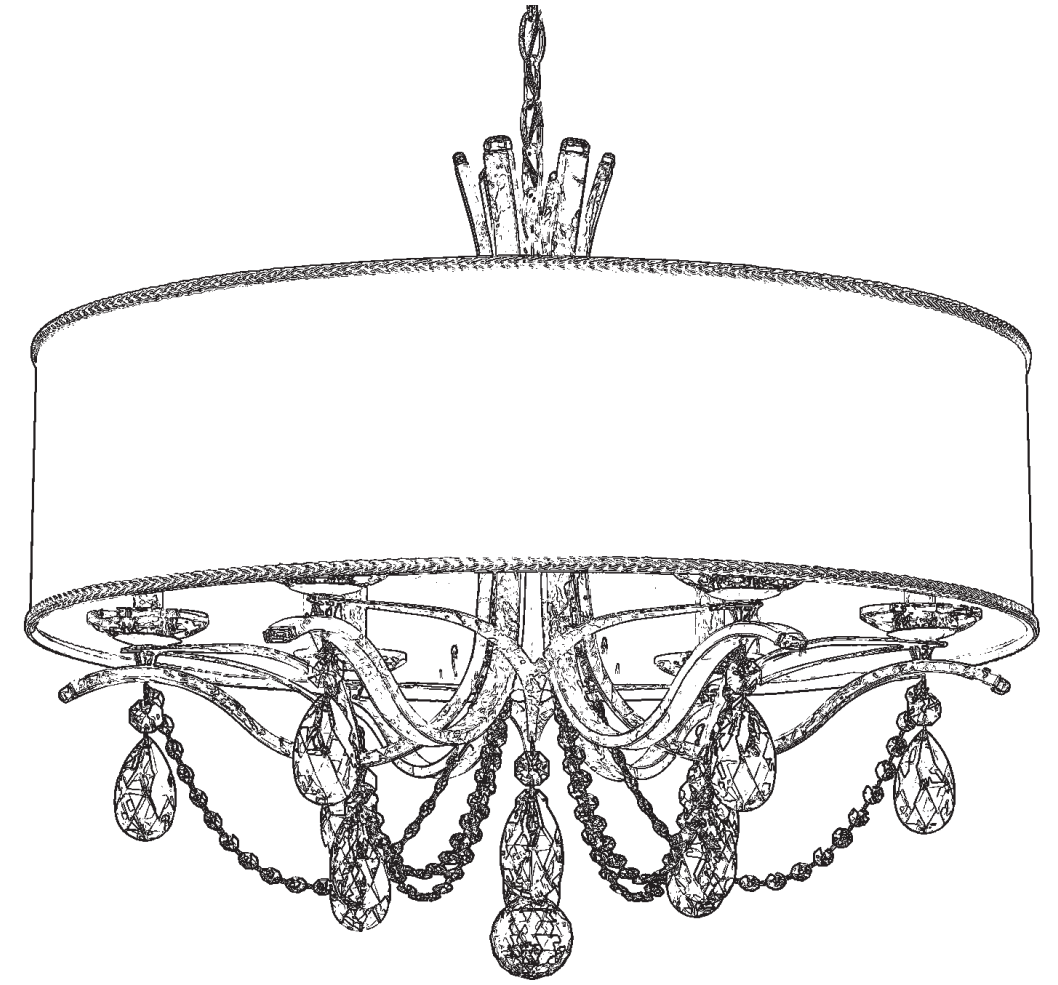











6 Lights
Diameter: 28"
Height: 24"
Hanging Weight: 20lbs.

THIS DESIGN IS THE PROPRIETARY
TRADE DRESS/TRADEMARK OF
W SCHONBEK LLC.

 **SCHONBEK** | 1870

 **SCHONBEK** | 1870

								
MAX <u>60</u> W	110-120 V							

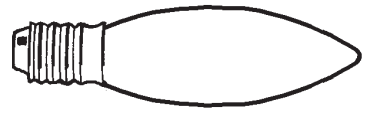

You will need 6 - B10
25 Watts Recommended
60 Watts Max

**Install bulbs and be sure
to test fixture BEFORE
trimming.**

NOTE: INSTALL BOBECHÉ,
CANDLESLIPS AND BULBS
BEFORE INSTALLING SHADE.

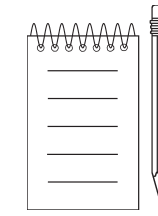
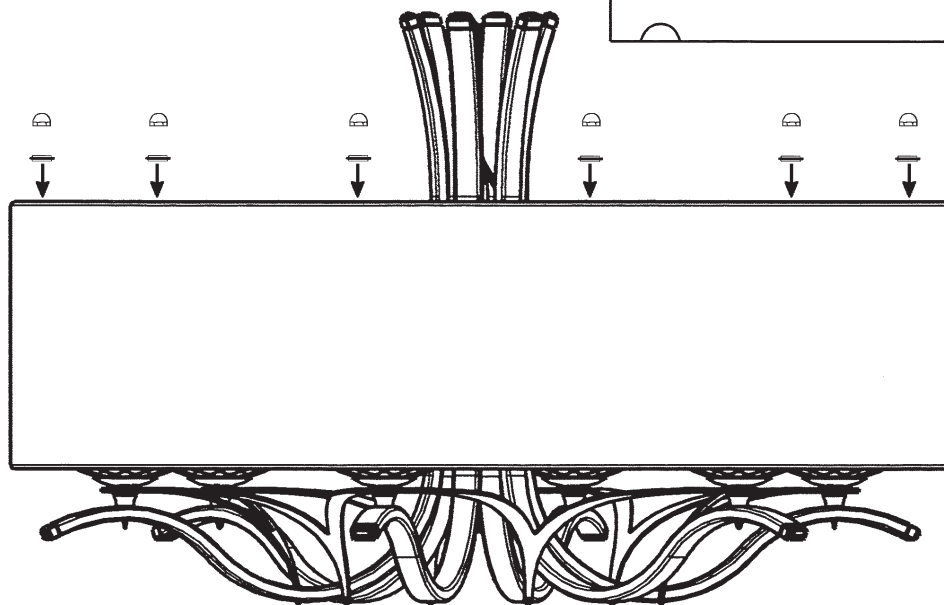
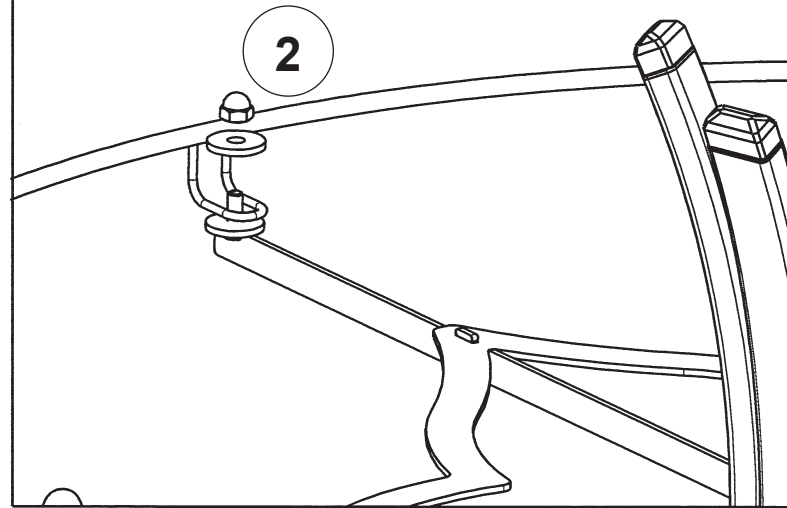
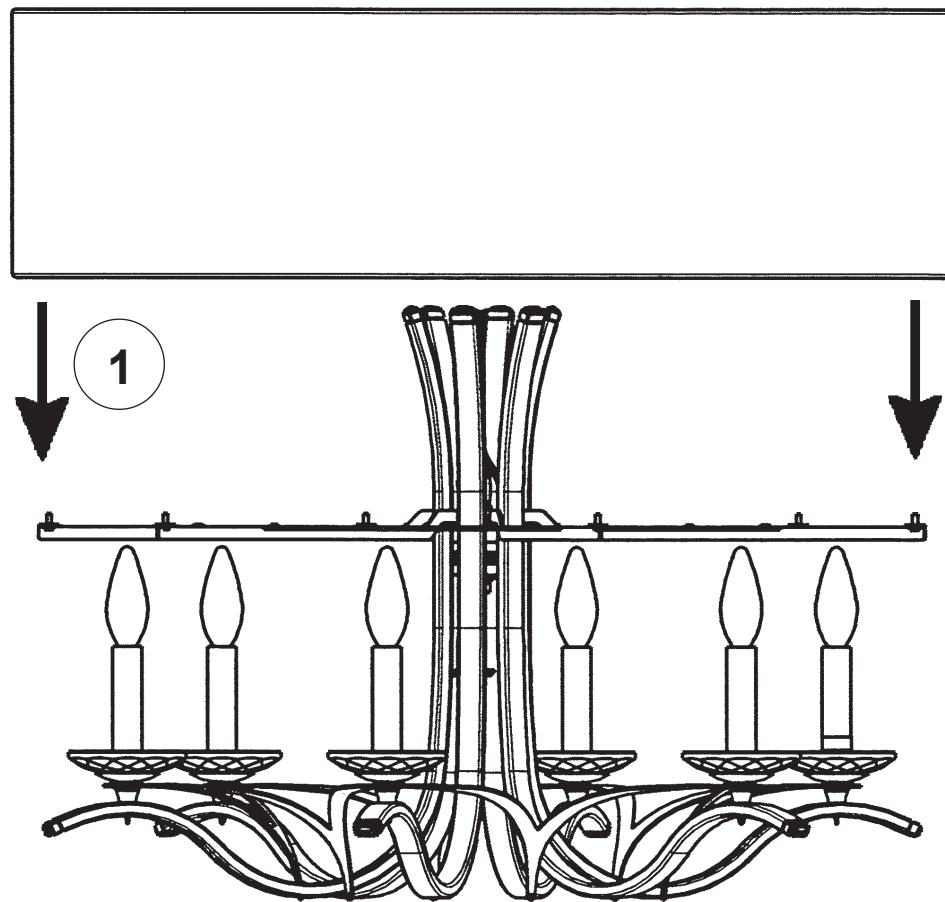

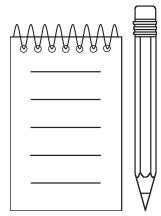

3 **WARNING:**

Electrical Danger Turn Power Off

All electrical components must be installed by a licensed electrician in accordance with the National Electric Code and the appropriate local electrical codes.

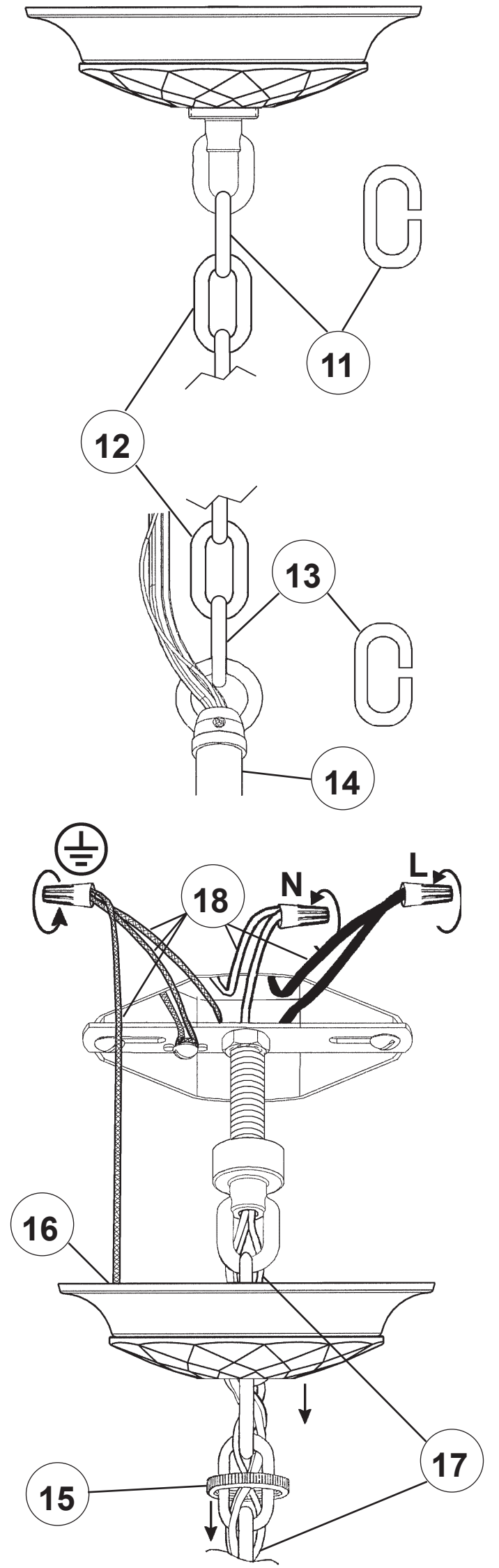
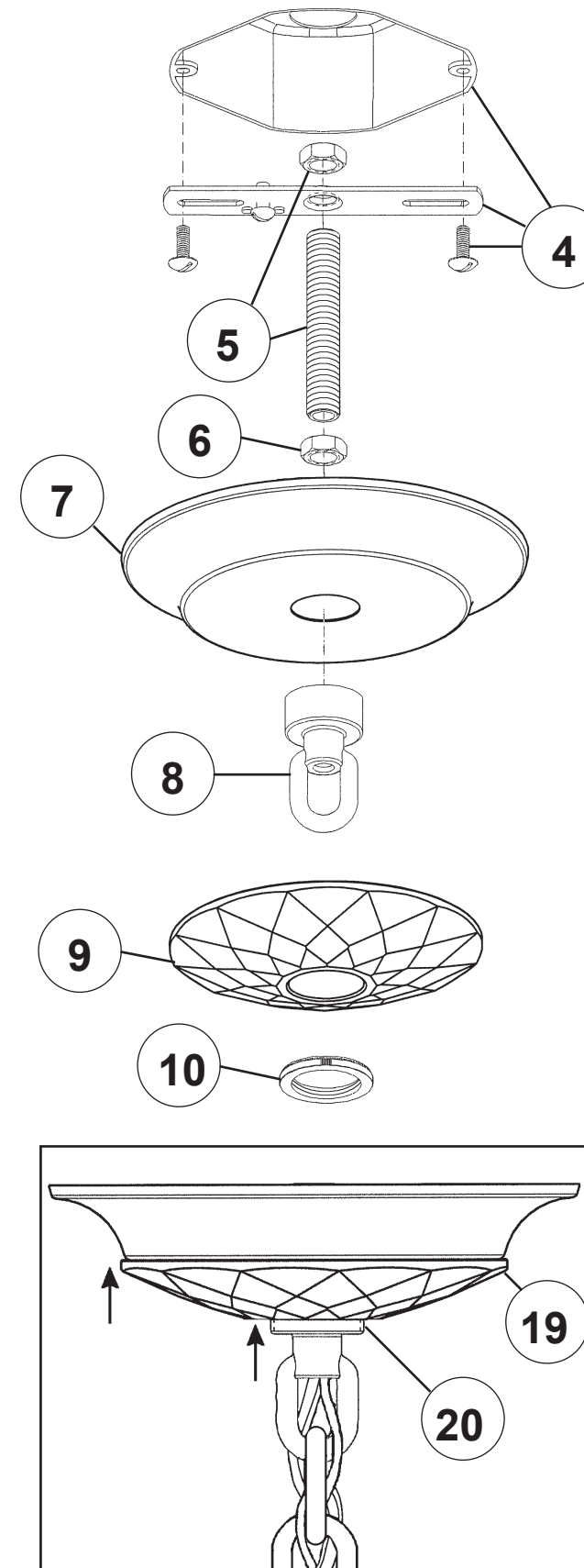

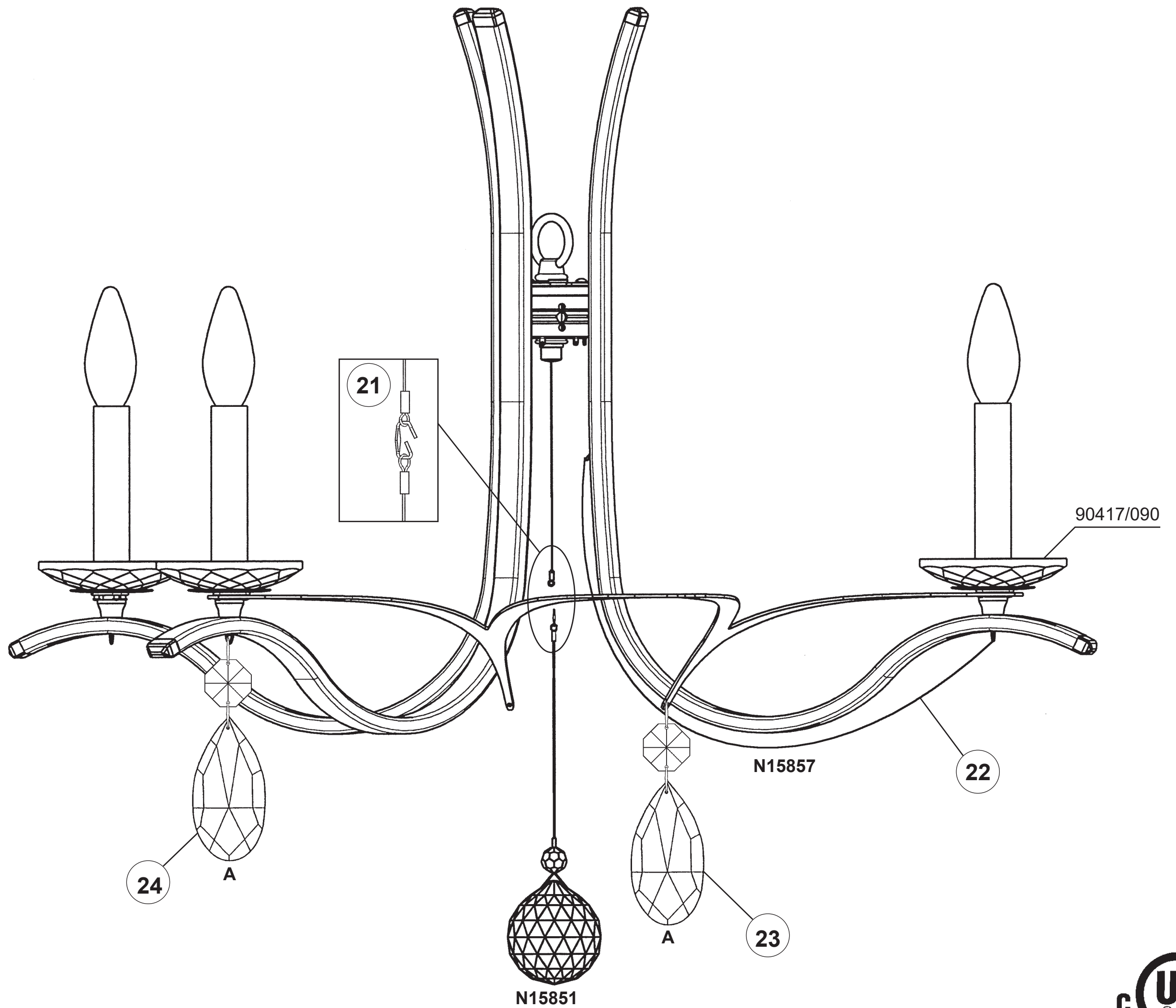

VESCA VA8306N- __ __ R

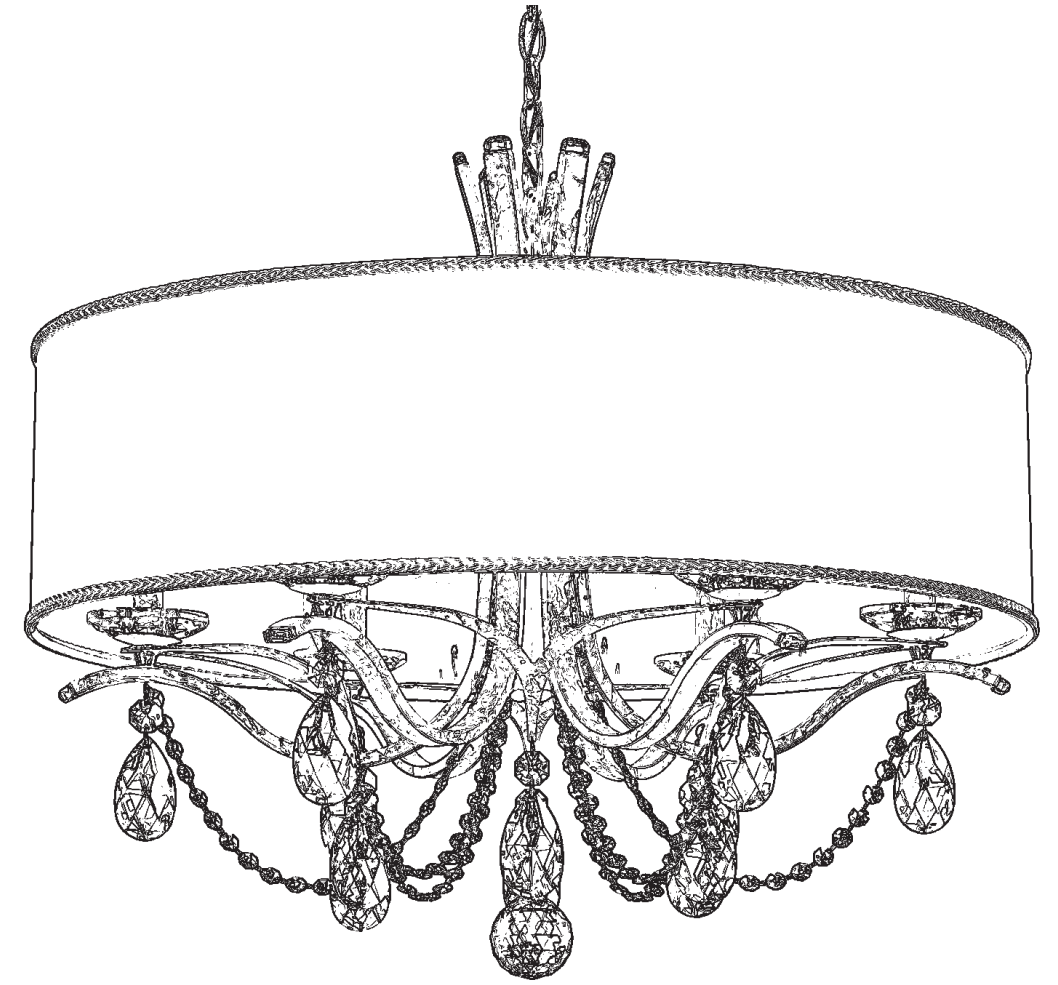











6 Lights
Diameter: 28"
Height: 24"
Hanging Weight: 20lbs.

THIS DESIGN IS THE PROPRIETARY
TRADE DRESS/TRADEMARK OF
W SCHONBEK LLC.

 **SCHONBEK** | 1870

 **SCHONBEK** | 1870

								
MAX 60 W	110-120 V							

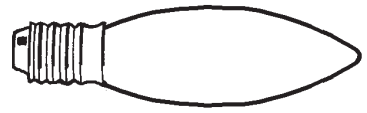

You will need 6 - B10
25 Watts Recommended
60 Watts Max

**Install bulbs and be sure
to test fixture BEFORE
trimming.**

NOTE: INSTALL BOBECHE,
CANDLE SLIPS AND BULBS
BEFORE INSTALLING SHADE.

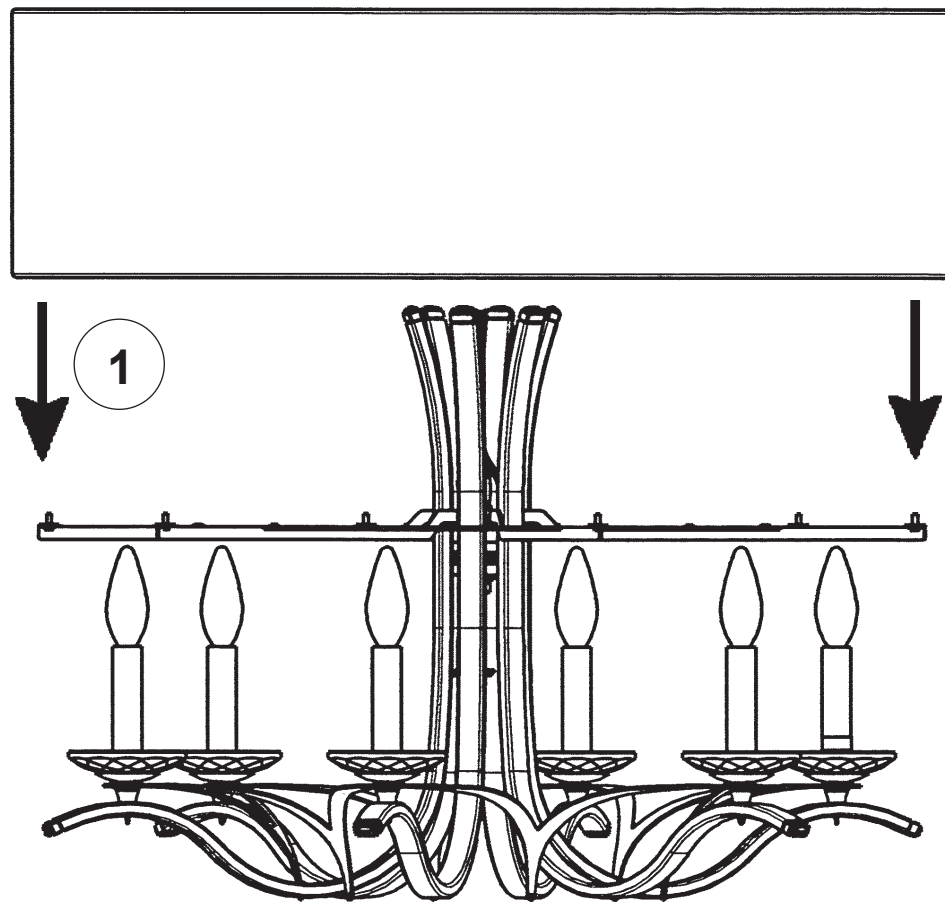

2

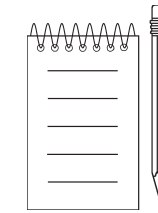
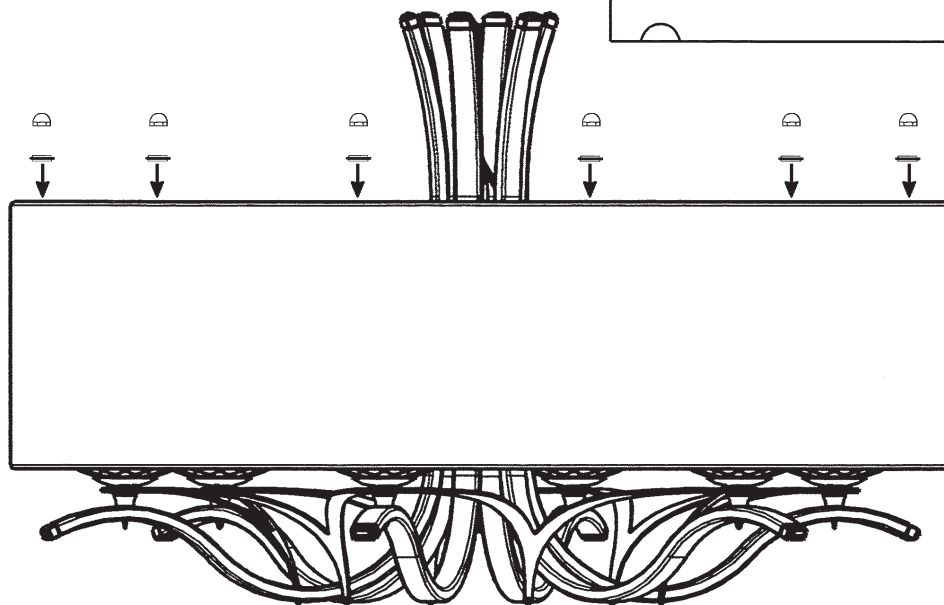
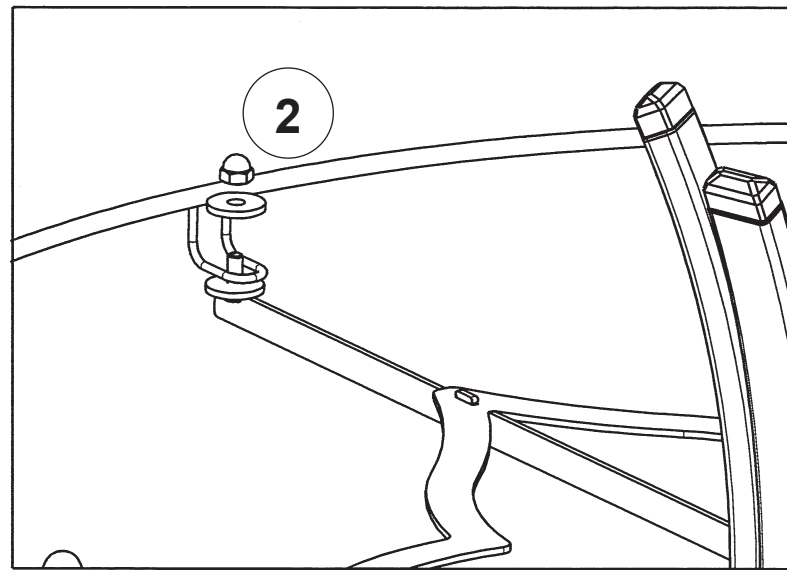

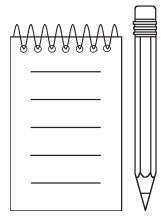

3 **WARNING:**

Electrical Danger Turn Power Off

All electrical components must be installed by a licensed electrician in accordance with the National Electric Code and the appropriate local electrical codes.

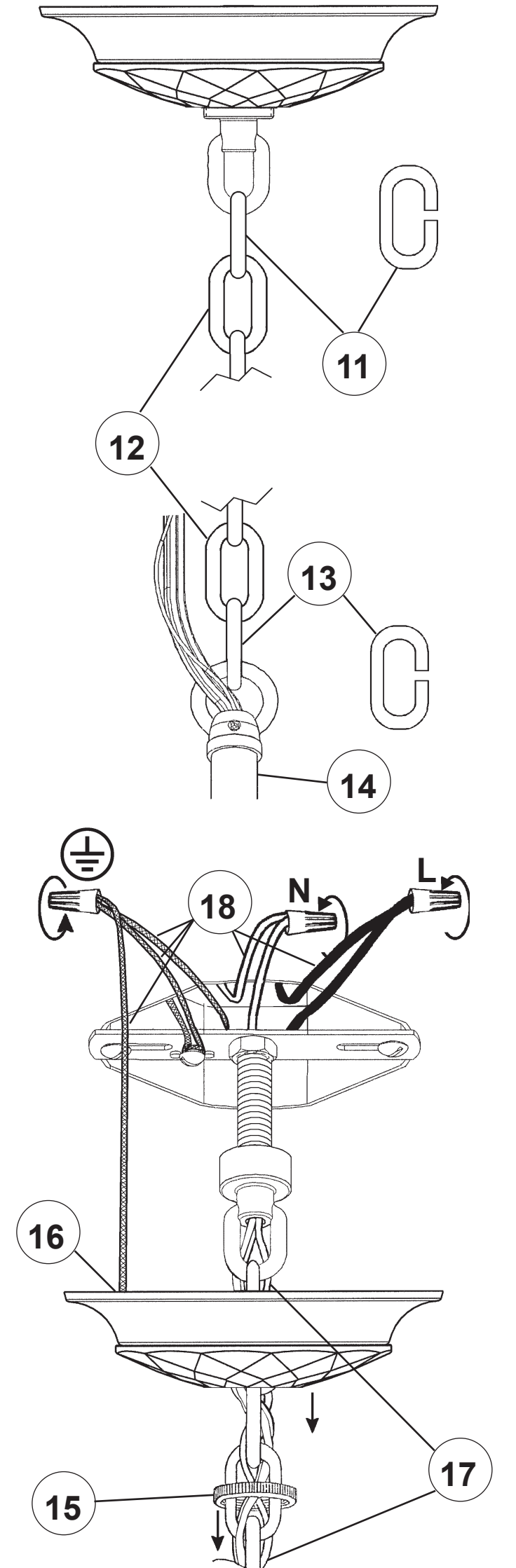
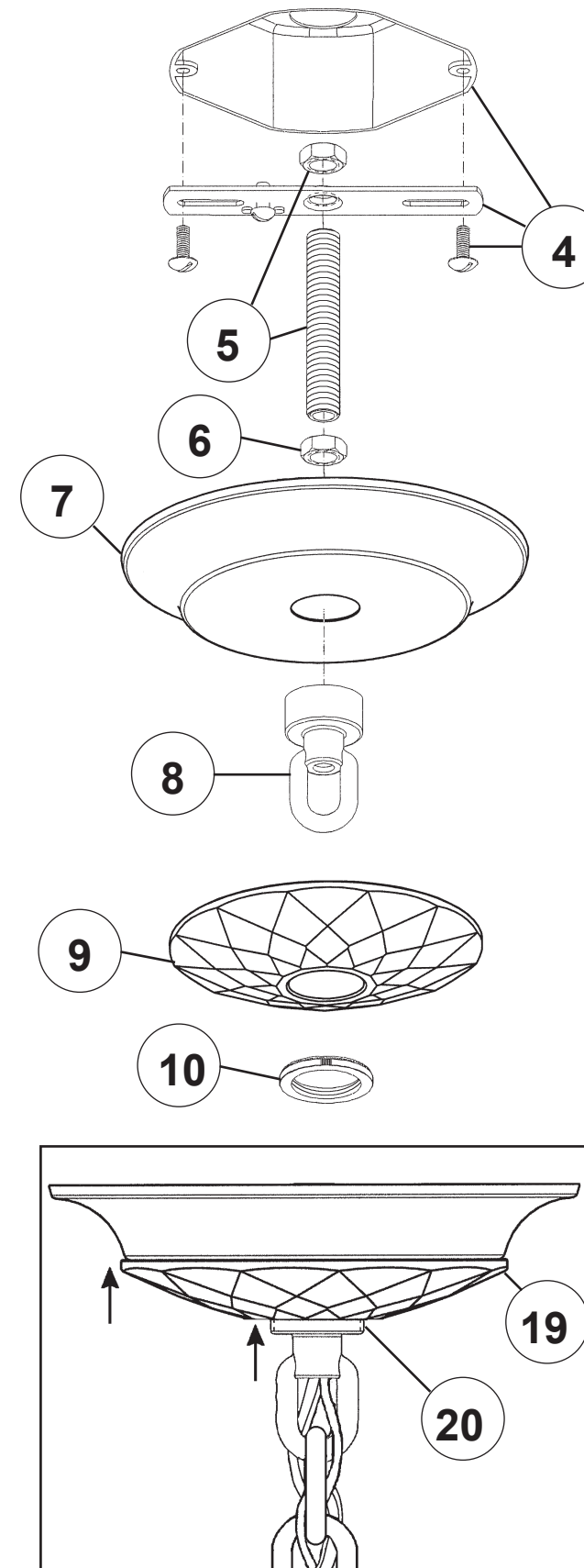

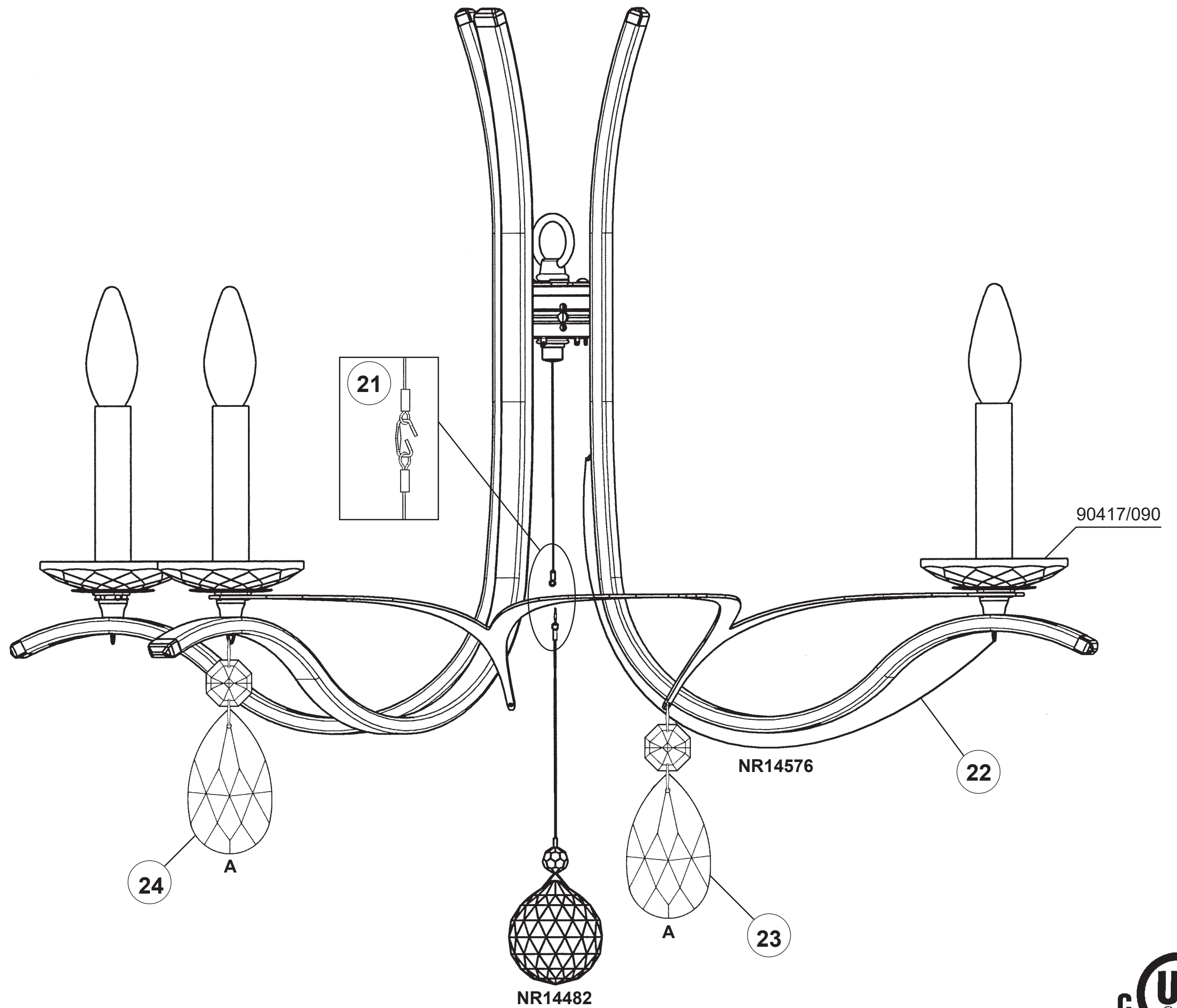

VESCA VA8306N- __ __ S

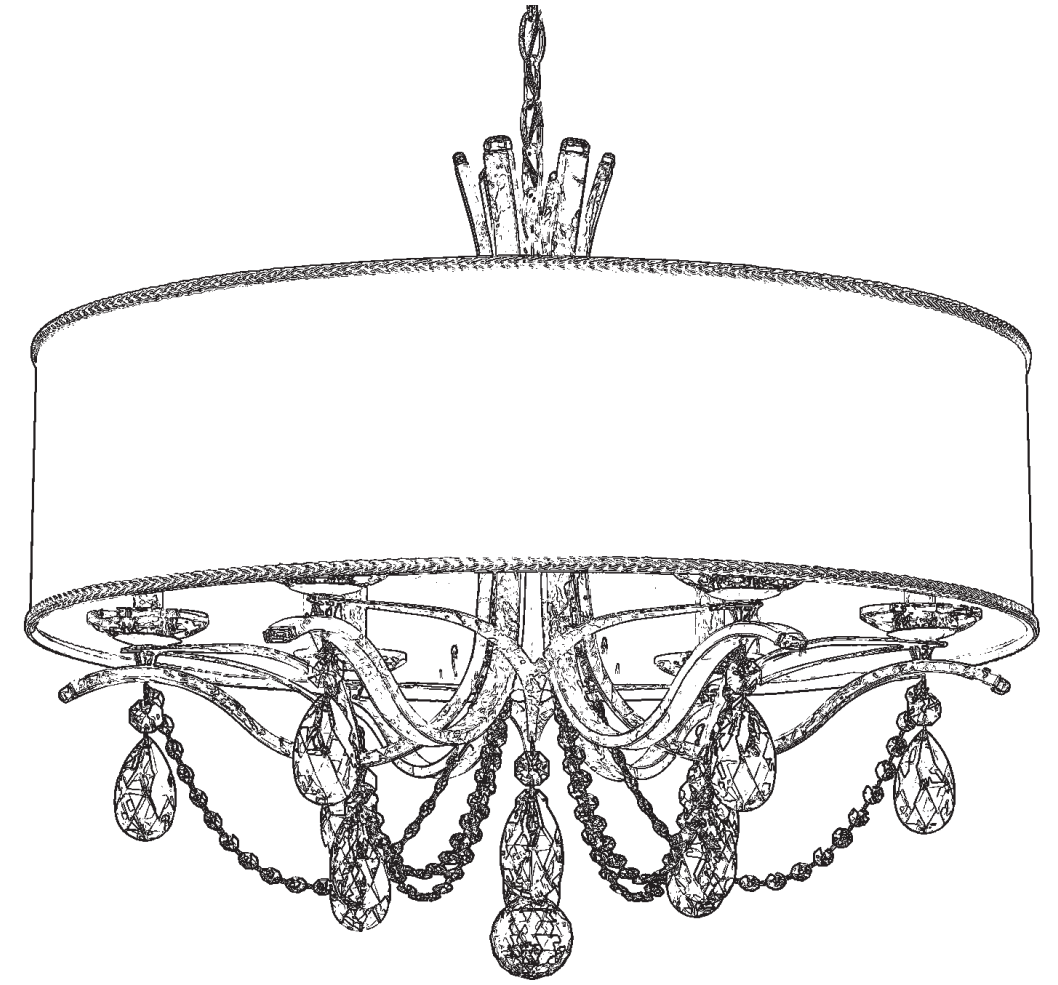











6 Lights
Diameter: 28"
Height: 24"
Hanging Weight: 20lbs.

THIS DESIGN IS THE PROPRIETARY
TRADE DRESS/TRADEMARK OF
W SCHONBEK LLC.

 **SCHONBEK** | 1870

 **SCHONBEK** | 1870

								
MAX 60 W	110-120 V							

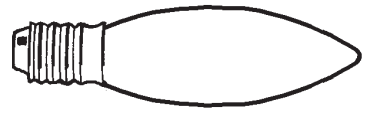

You will need 6 - B10
25 Watts Recommended
60 Watts Max

**Install bulbs and be sure
to test fixture BEFORE
trimming.**

NOTE: INSTALL BOBECHÉ,
CANDLE SLIPS AND BULBS
BEFORE INSTALLING SHADE.

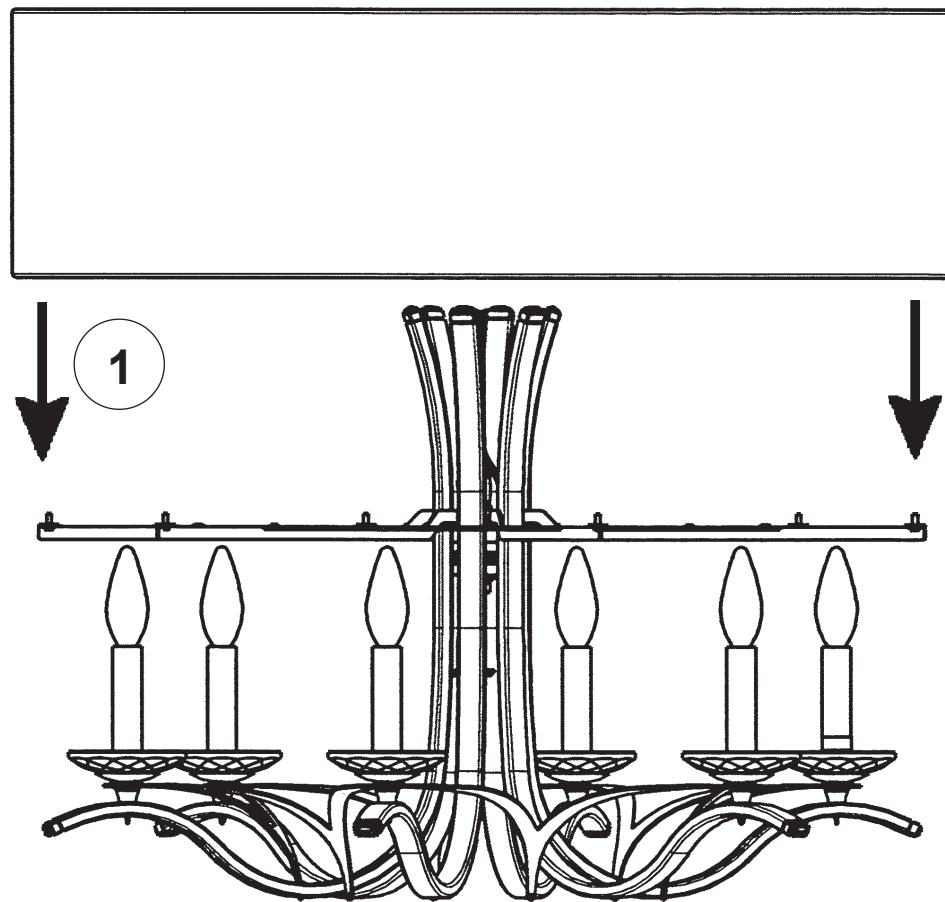

2

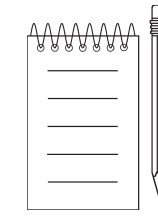
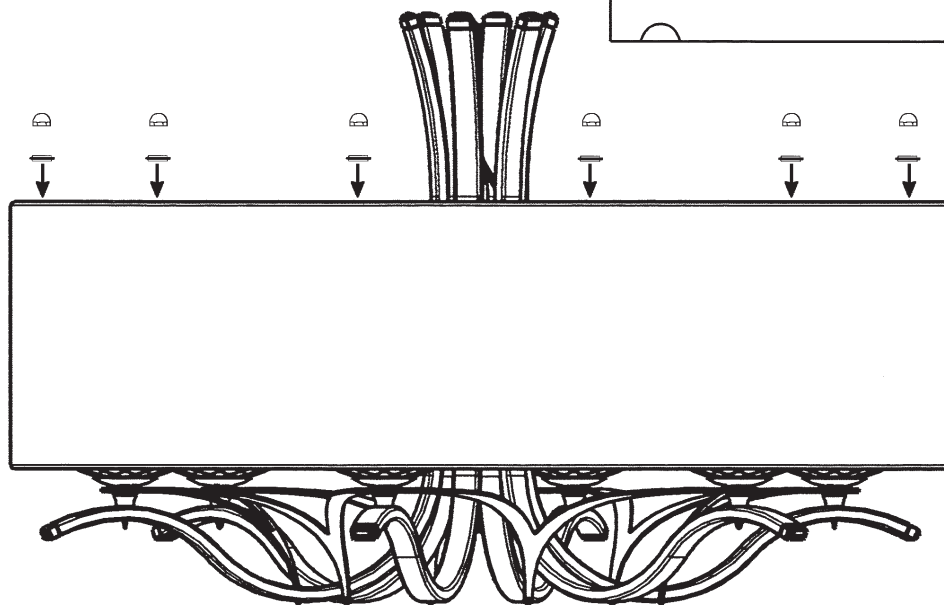
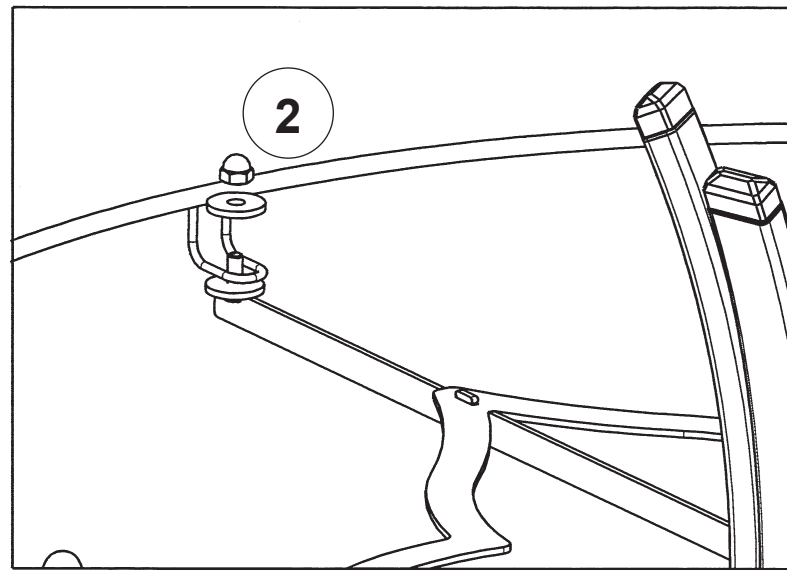

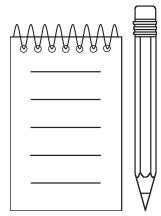

3 **WARNING:**

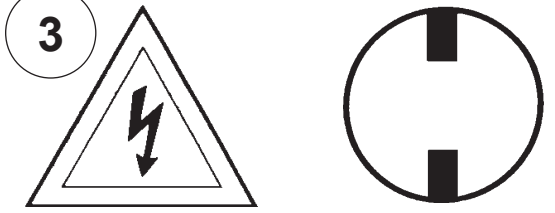

Electrical Danger Turn Power Off

All electrical components must be installed by a licensed electrician in accordance with the National Electric Code and the appropriate local electrical codes.

