

VESCA VA8339N- __ __ H

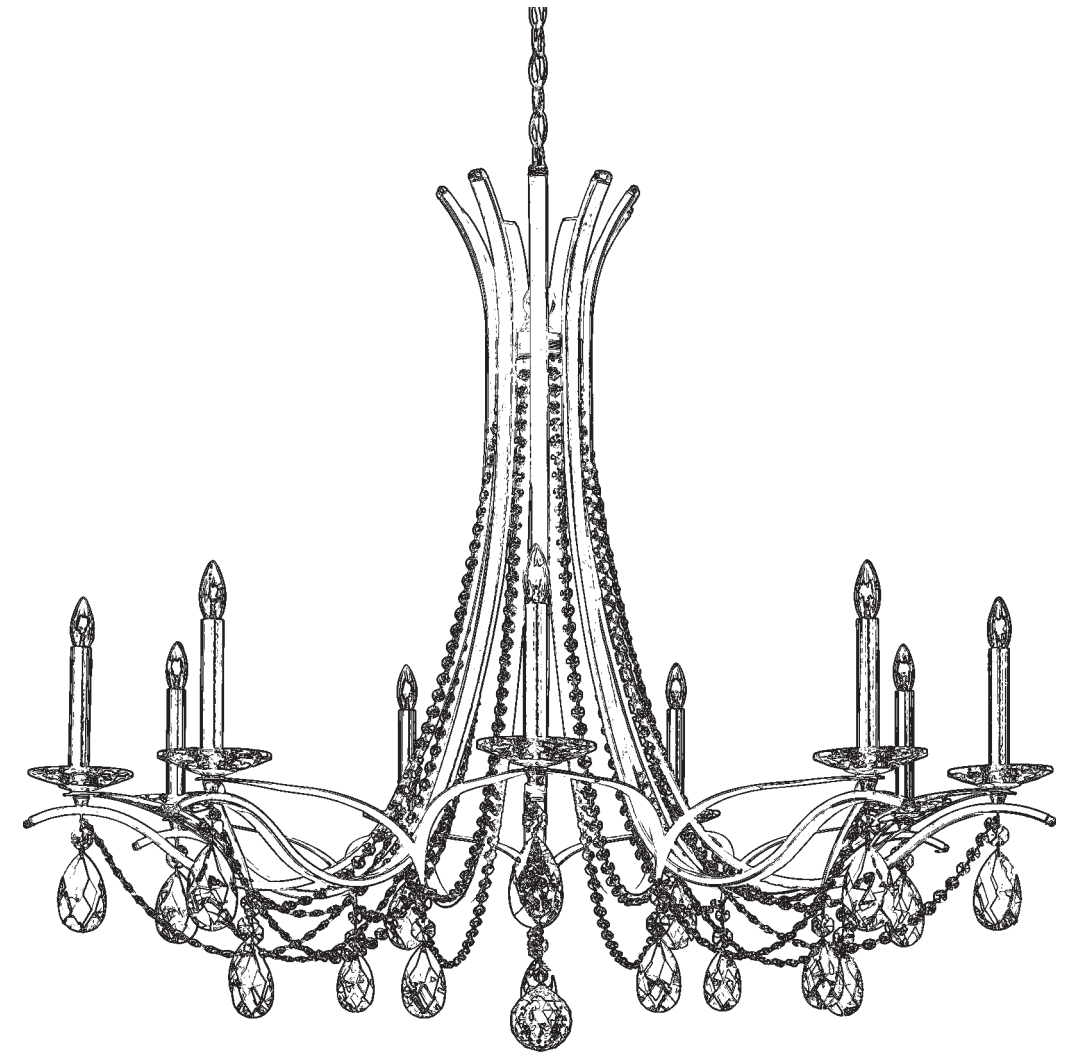











9 Lights
Diameter: 45"
Height: 38"
Hanging Weight: 35lbs.

THIS DESIGN IS THE PROPRIETARY
TRADE DRESS/TRADEMARK OF
W SCHONBEK LLC.

 **SCHONBEK** | 1870

 **SCHONBEK** | 1870

								
MAX <u>60</u> W	110-120 V							

WARNING:

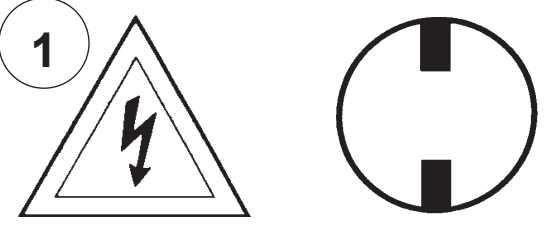
1 

Electrical Danger Turn Power Off

All electrical components must be installed by a licensed electrician in accordance with the National Electric Code and the appropriate local electrical codes.

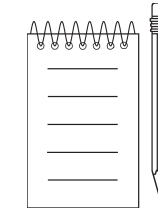
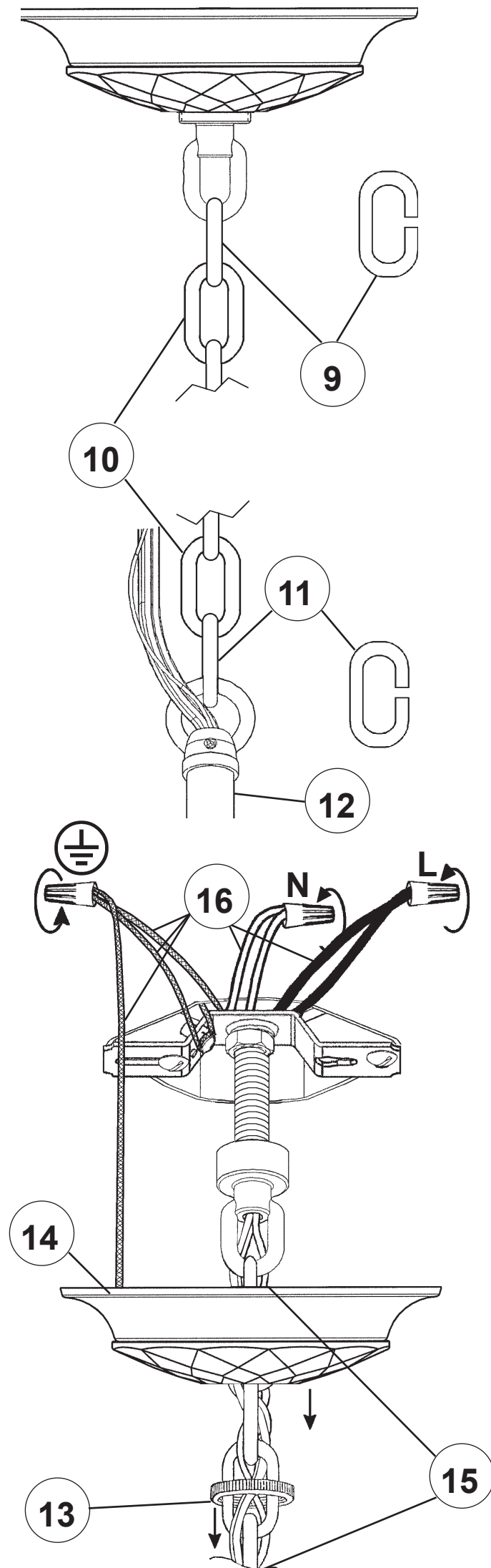
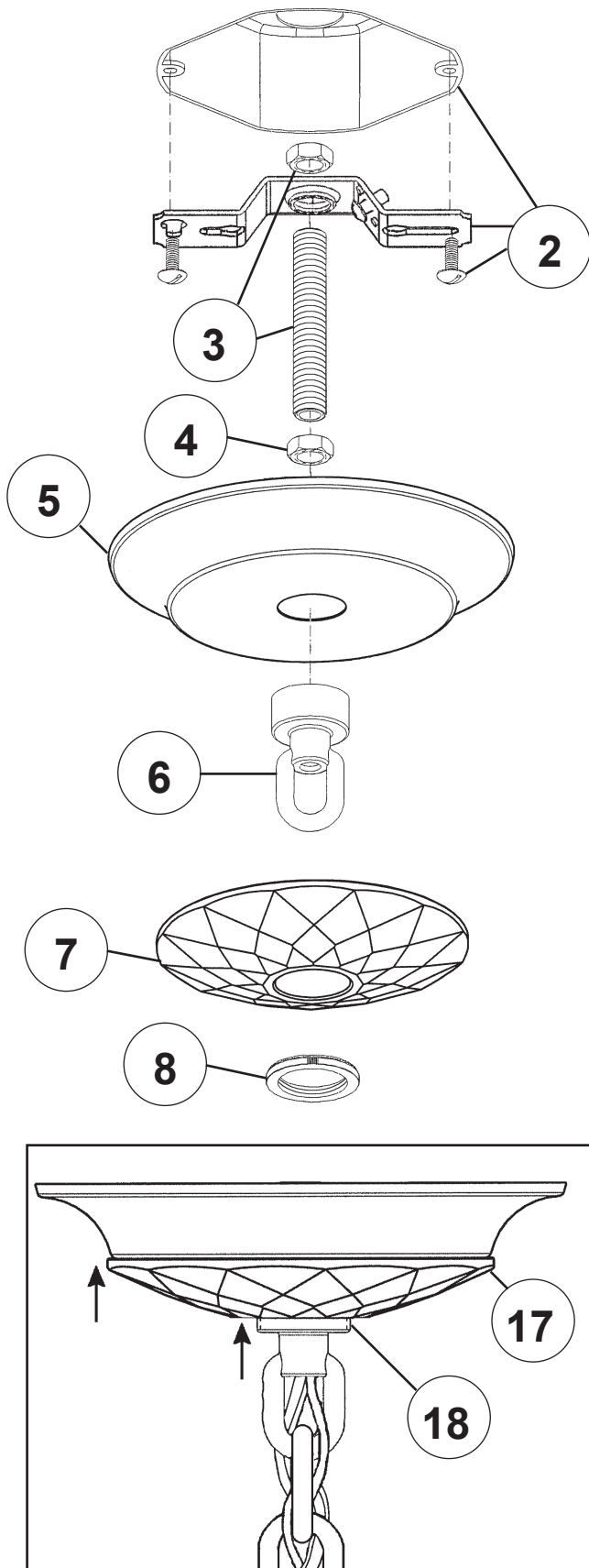

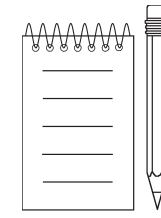
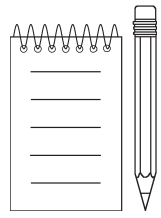

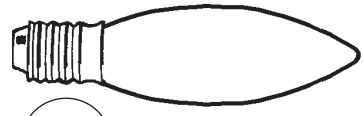

19

You will need 9 - B10
25 Watts Recommended
60 Watts Max

Install bulbs and be sure
to test fixture **BEFORE**
trimming.

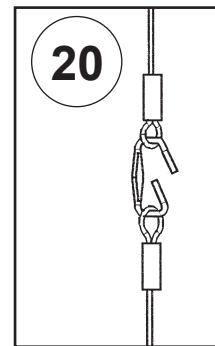

20

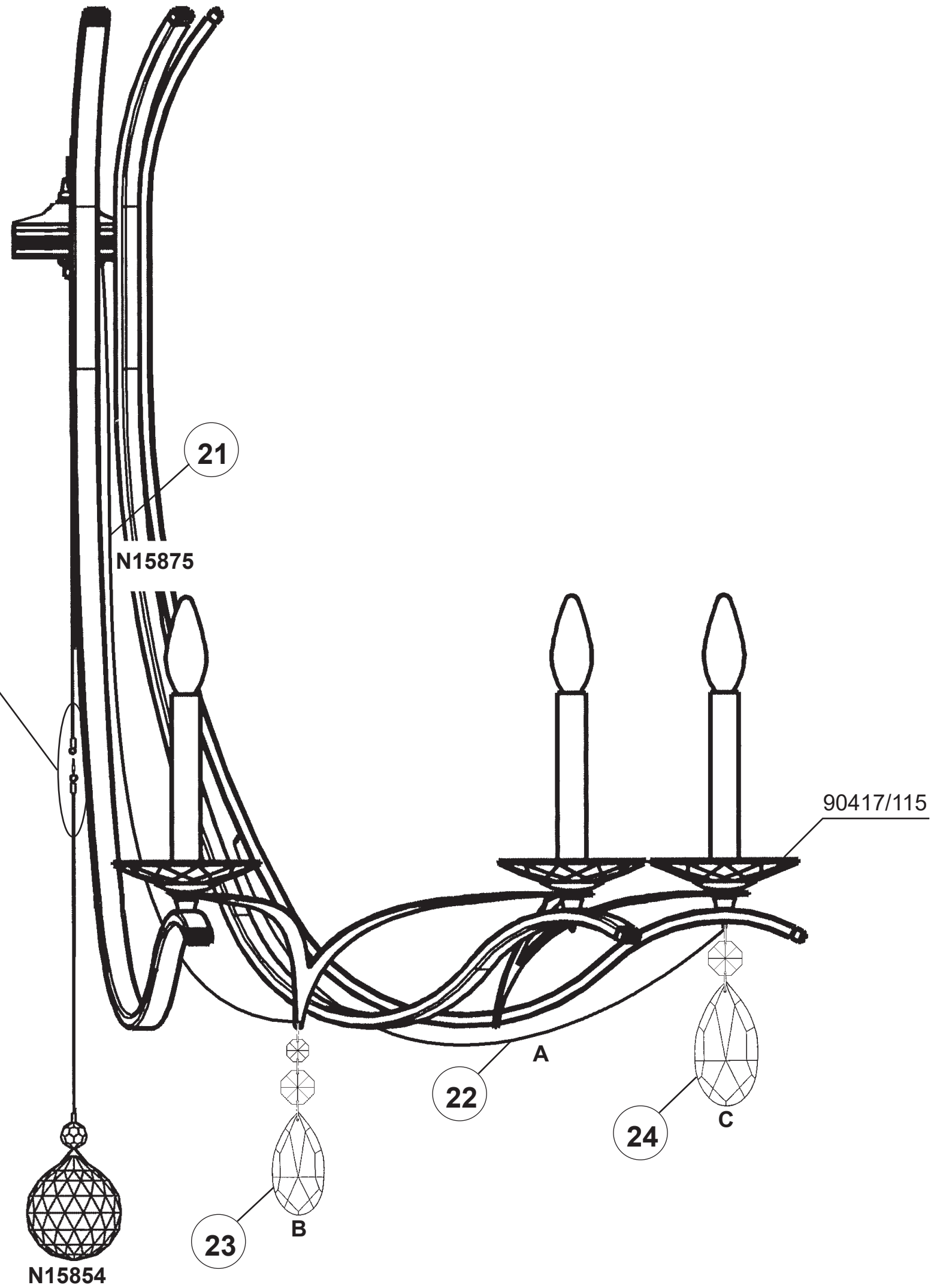

 **SCHONBEK** | 1870



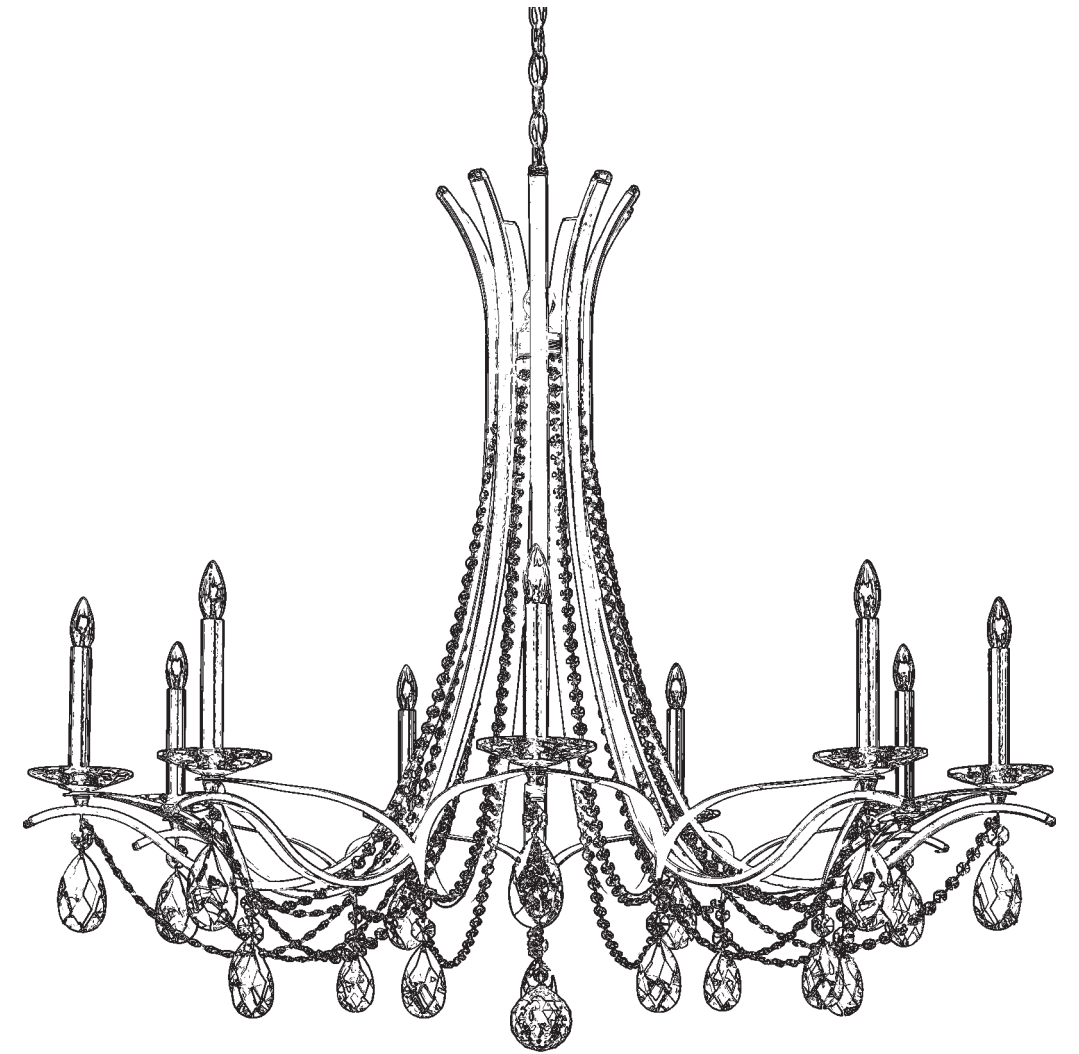







VESCA VA8339N- __ __R



9 Lights
Diameter: 45"
Height: 38"
Hanging Weight: 35lbs.

THIS DESIGN IS THE PROPRIETARY
TRADE DRESS/TRADEMARK OF
W SCHONBEK LLC.

 **SCHONBEK** | 1870

								
MAX <u>60</u> W	110-120 V							

WARNING:

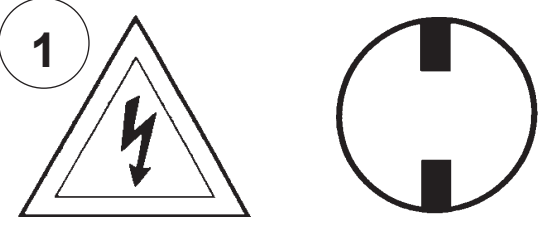
1 

Electrical Danger Turn Power Off

All electrical components must be installed by a licensed electrician in accordance with the National Electric Code and the appropriate local electrical codes.

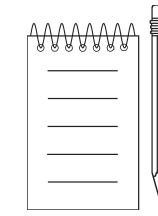
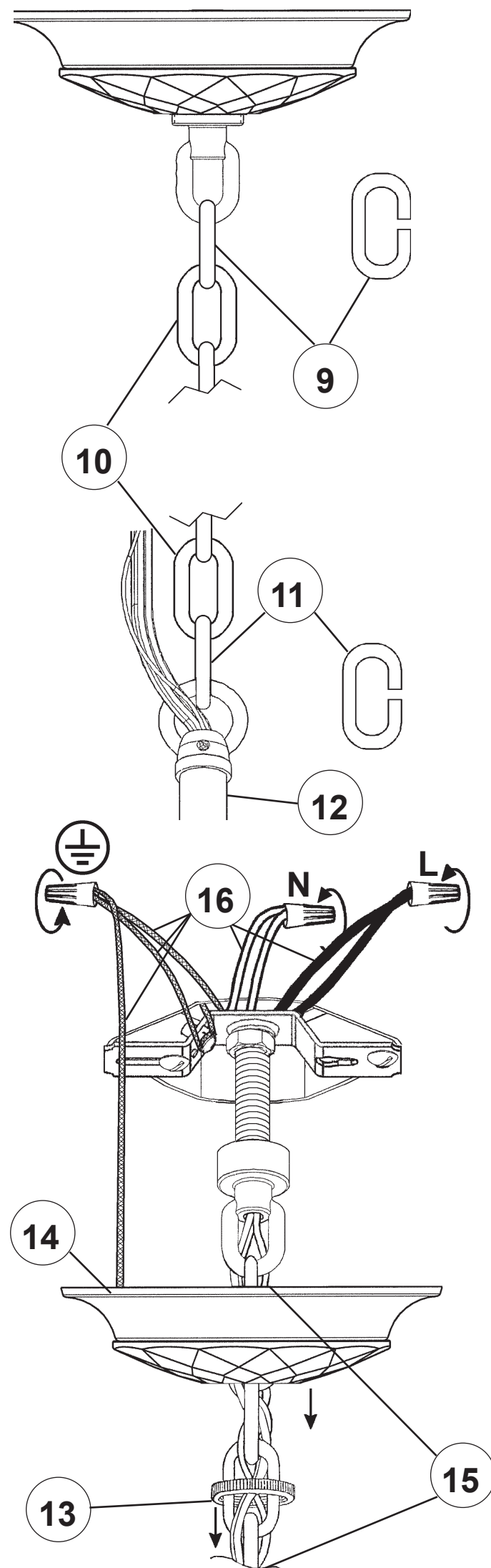
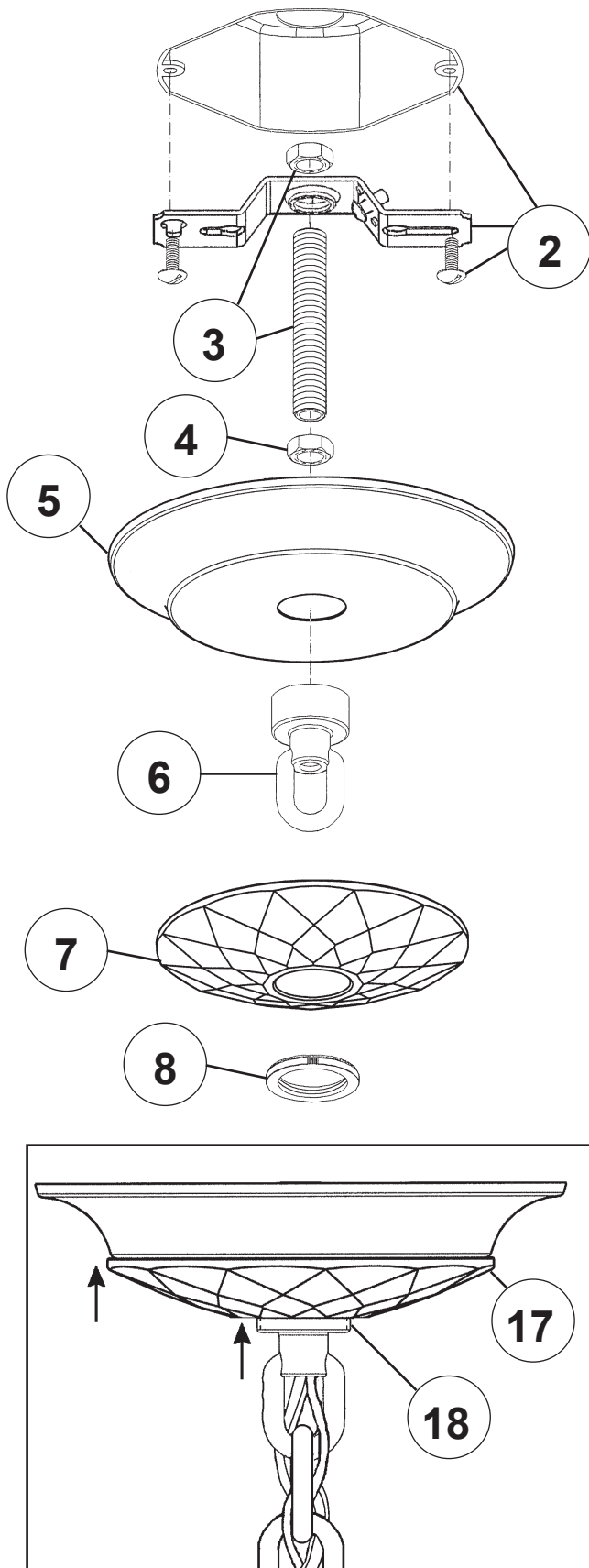

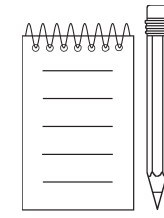
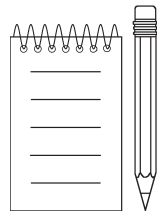

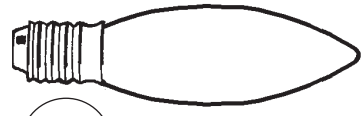

19

You will need 9 - B10
25 Watts Recommended
60 Watts Max

Install bulbs and be sure
to test fixture **BEFORE**
trimming.

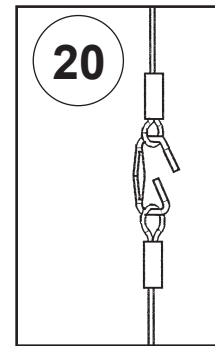

20

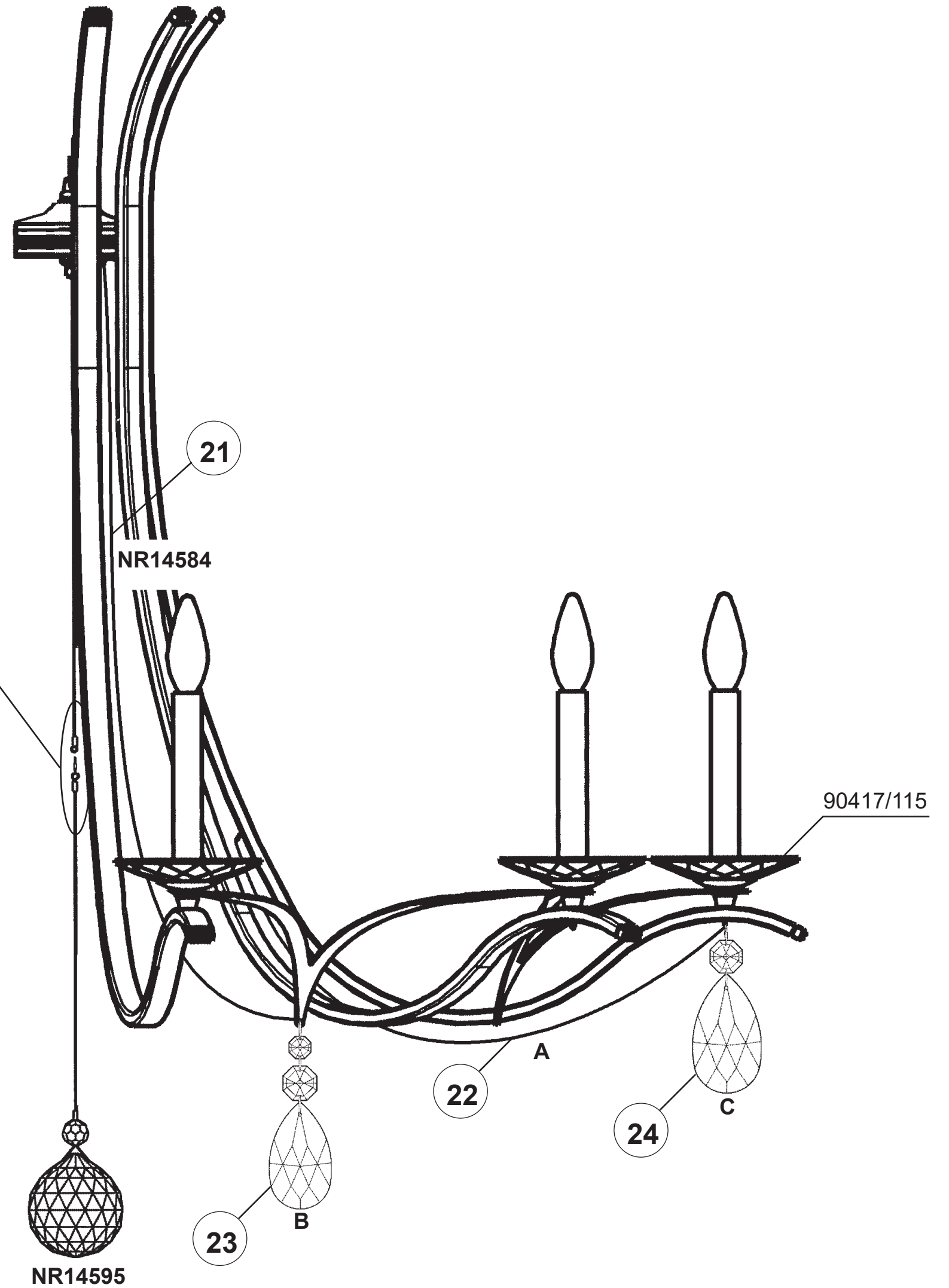

VESCA VA8339N- __ __ S

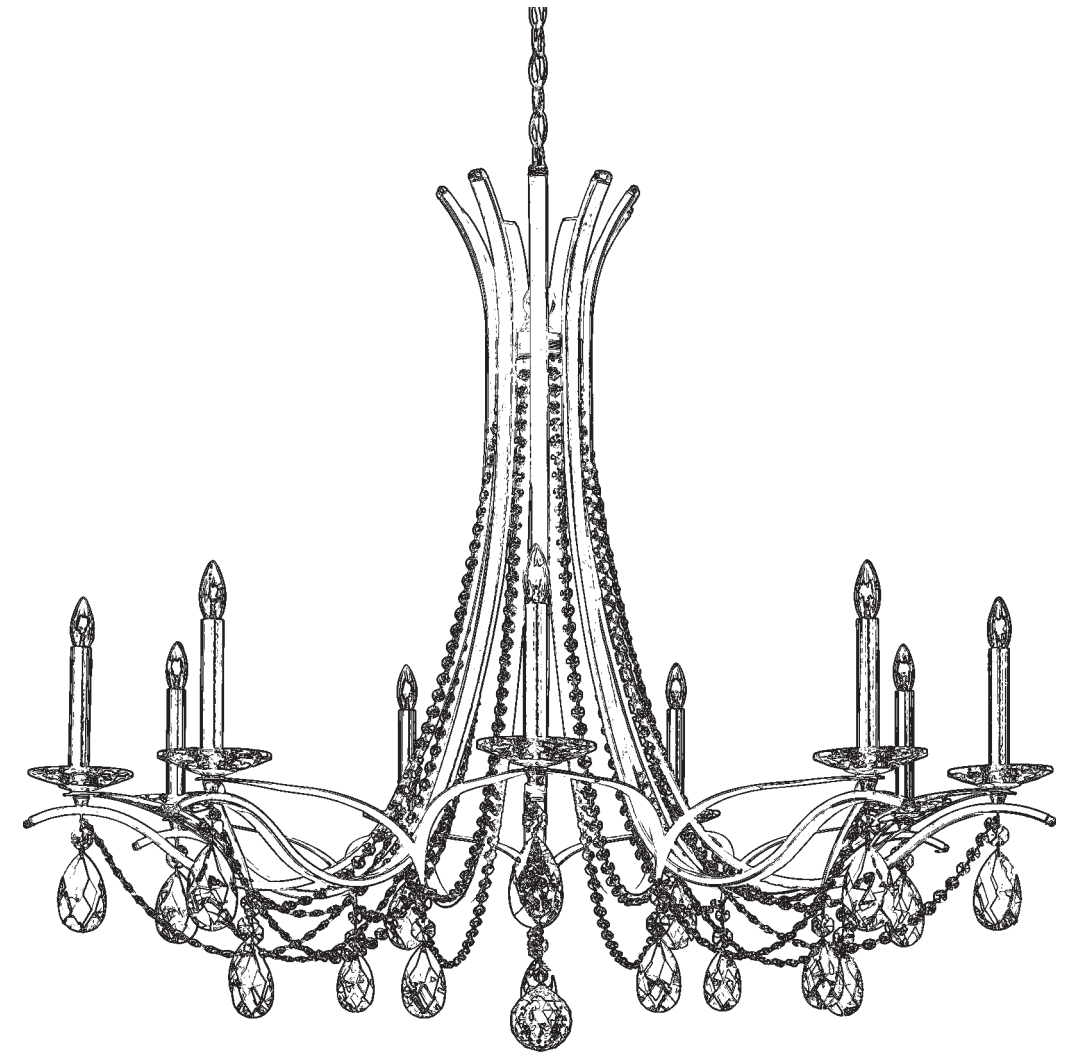











9 Lights
Diameter: 45"
Height: 38"
Hanging Weight: 35lbs.

THIS DESIGN IS THE PROPRIETARY
TRADE DRESS/TRADEMARK OF
W SCHONBEK LLC.

 **SCHONBEK** | 1870

 **SCHONBEK** | 1870

								
MAX <u>60</u> W	110-120 V							

WARNING:

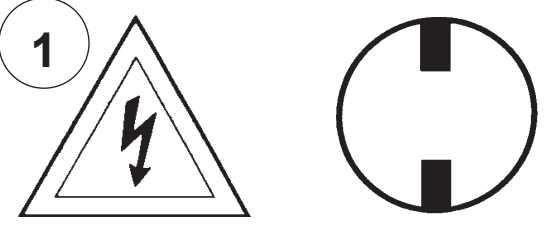
1 

Electrical Danger Turn Power Off

All electrical components must be installed by a licensed electrician in accordance with the National Electric Code and the appropriate local electrical codes.

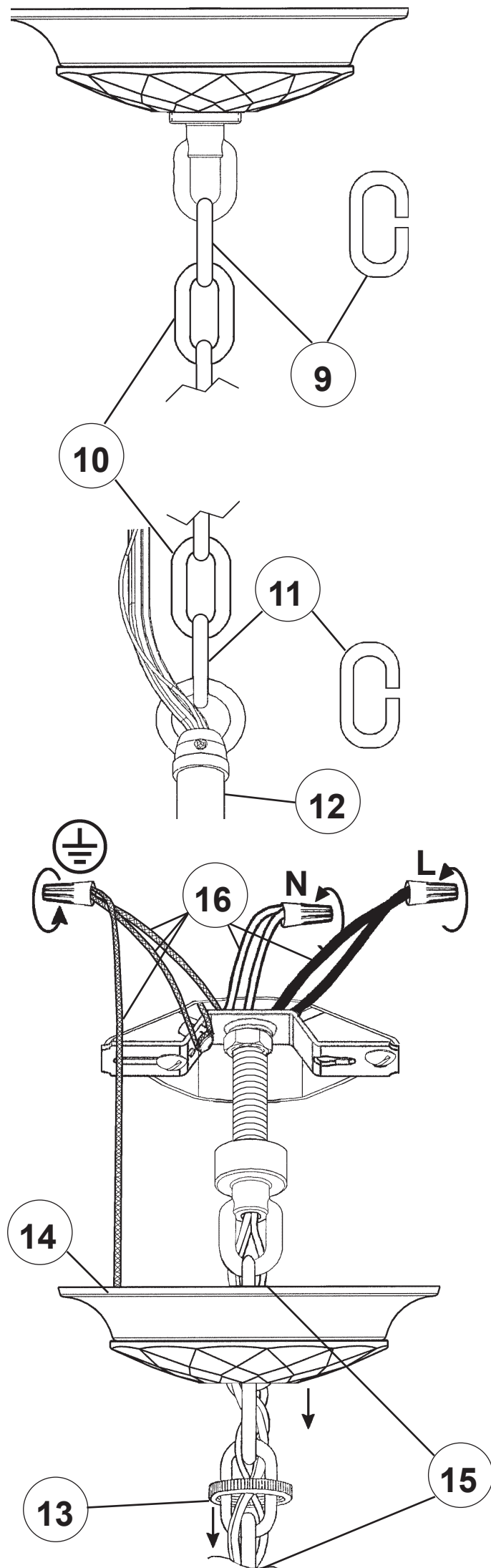
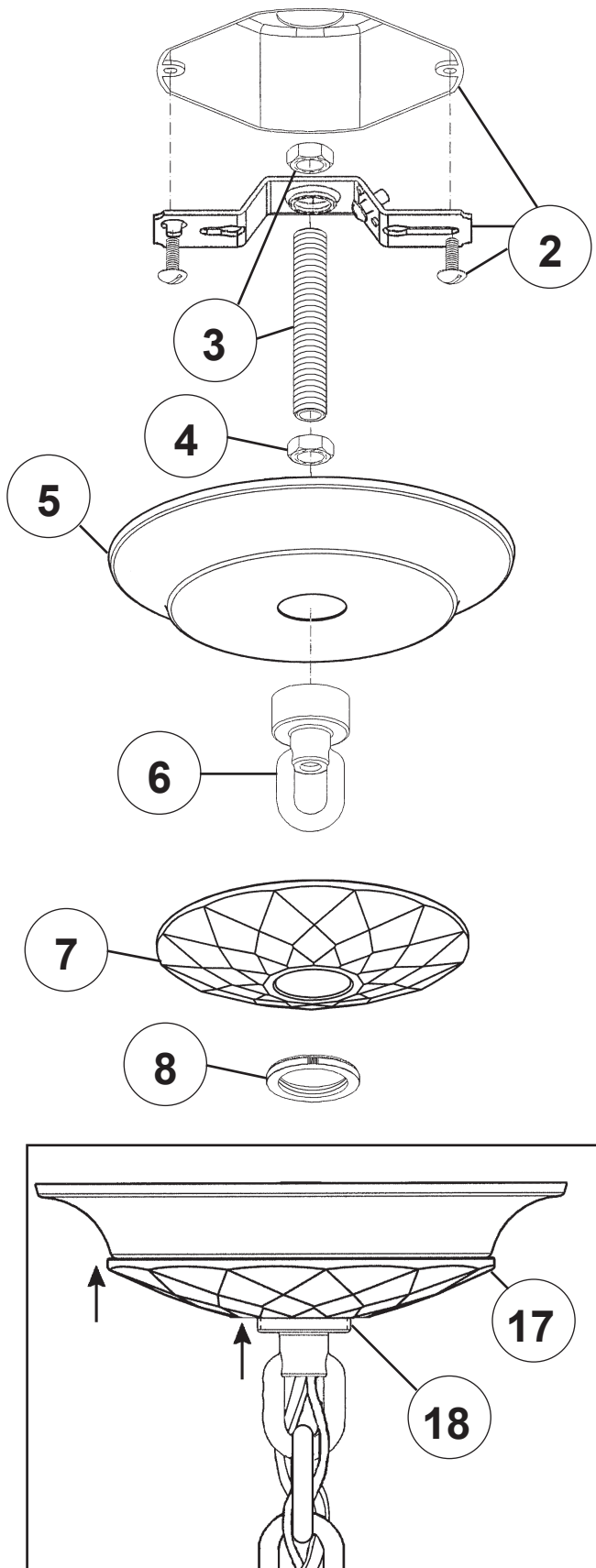

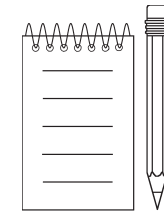



19

You will need 9 - B10
25 Watts Recommended
60 Watts Max

Install bulbs and be sure
to test fixture **BEFORE**
trimming.

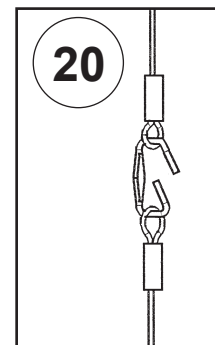

20

